

ARYSTO

ULTIMATE SHOWERING EXPERIENCE



ARYSTO

Bespoke Collection

The Arysto Bespoke Collection enables you to create a truly unique enclosure personalised to your preferences.

See Arysto Bespoke section for more details or log on to **www.merlynshowering.com**



SCAN FOR MORE
INFORMATION



ARYSTO 10 Bespoke Three Panel Hinged Door in Recess / Shown in Brushed Bronze



ARYSTO 10 Hinge & Inline Door with Side Panel / Brushed Bronze shown as Left Hand (L)

Contents

Collections

ARYSTO X

The Sliding Door Collection.....3

The Wetroom Collection.....6

ARYSTO TEN

The Sliding Door Collection..... 13

The Hinged Door Collection..... 25

The Wetroom Collection..... 45

THE BESPOKE COLLECTION..... 53

ARYSTO EIGHT 63

ARYSTO SLEEK..... 75

THE BATH SCREEN COLLECTION 105

MERLYN TRAYS 111

TrueStone Trays 113

Level25 & Level25-SR Trays 117

Touchstone-SR Trays 119

MStone..... 120

[Product Information..... 121](#)

ARYSTO X

Universal Design



Up to height 2015mm

Eyelet handle & towel rail handle option available

 **Colour Finishes;**
Express Yourself

ARYSTO TEN

Unique & Stylish



Up to height 2015mm

Designer hinges highly engineered to ensure smooth and solid opening and closing

Bespoke options available

Colour options available in Hinge & Inline Collection

 **Colour Finishes;**
Express Yourself

Bespoke Sanctuary



ARYSTO BESPOKE

Bespoke options, angle & notch cuts etc available made to measure

Up to 2000mm width & 2400mm height

Five colour hardware options

Four glass types available

High quality designer hinges & parts

 **Colour Finishes;**
Express Yourself

The ARYSTO COLLECTION

The ARYSTO collection offers the perfect mix of ultra-modern design and expert craftsmanship, producing stunning shower enclosures that make the perfect centrepiece in your bathroom. Revolutionary state-of-the-art technical innovations are used across the collection to achieve designs that have a beautifully crafted visual balance, making them gorgeous to look at and a pleasure to use.

Our flawless designs captivate with smooth flowing curves, crisp contemporary lines and show-stopping innovations. Whether you're relaxing or recharging, an ARYSTO shower will transform your bathroom into a luxury escape.

INDULGE IN THE ULTIMATE SHOWERING EXPERIENCE

ARYSTO EIGHT

Award Winning



Height 2000mm

Ultra slim profiles and subtle design detailing enhance the quality of these enclosures

Ultra smooth rolling action ensures this door effortlessly glides open and closed

ARYSTO SLEEK

Luxury Refreshed



Height 1950mm

Recyclable packaging

Quick & easy installation

Reversible

 **Colour Finishes;**
Express Yourself

MERLYN™

it's all about the experience

At MERLYN we have a relentless desire to deliver the highest level of service to you and our award-winning customer service team live this ethos every day.

Our promise is to be with you on every step of your MERLYN journey from end to end. We have a genuine commitment to service and to finding a solution for you. Our specialised team's philosophy is to make everything easy for you and we will respond to any request you might have. We strive each day to make excellence a habit. This unique approach has helped us to become the leading brand for shower enclosures in the UK.

Thank you for choosing MERLYN.

Sincerely,

The MERLYN Team





Follow us online @merlynshowering to keep up to-date.









Award-Winning Customer Service

It is not about what we do but what we can do for you. We strive everyday to make excellence a habit. Contact our award winning dedicated team of specialists, who are on hand to give you a personalised solution to your query.

 T: 0808 101 1429  WhatsApp: +353 8601 00 002  E: sales@merlyn.ie

-  Download our brochures
-  Find your nearest stockist
-  Download our easy-to-use fitting instructions and technical information
-  Register your Guarantee

Check out our website: merlynshowering.com



ARYSTO X

Escape from the everyday to a sanctuary of calm in the ARYSTO X the most frameless sliding shower door on the market.

Beneath the beautifully designed minimal frame lies a highly technical shower enclosure that gives the ARYSTO X its class leading functionality. To create a frameless 10mm door every element of its design and engineering has been pushed to perform multiple tasks.





Sliding Door with Side Panel shown as Left Hand (L) with eyelet handle - Shown in Matt Black



SLIDING DOOR - CHROME ONLY

Features

- » Ultra frameless.
- » Self cleaning anti-jump rollers. Infographic can be found on page 7.
- » Eyelet handle available.
- » Wetroom compatible.
- » Concealed fixings.
- » Fixed front panel maximises functionality with a full-length towel rail handle, while the sliding door creates an exceptionally wide entry opening.
- » Now available in four new colours.

SLIDING DOOR								
Size	Code	Adjustment in Recess Min-Max	Adjustment with Side Panel Min - Max	Door Opening X	Moving Panel A	Fixed P panel B	Price £ Exc. VAT	Price £ Inc. VAT
1000	ARXFSL100 (L or R)	965-1000	965-985	385	505	440	1734.17	2081.00
1100	ARXFSL110 (L or R)	1065-1100	1065-1085	435	555	490	1734.17	2081.00
1200	ARXFSL120 (L or R)	1165-1200	1165-1185	485	605	540	1741.67	2090.00
1300	ARXFSL130 (L or R)	1265-1300	1265-1285	535	655	590	1815.00	2178.00
1400	ARXFSL140 (L or R)	1365-1400	1365-1385	585	705	640	1954.17	2345.00
1500	ARXFSL150 (L or R)	1465-1500	1465-1485	585	705	740	2033.33	2440.00
1600	ARXFSL160 (L or R)	1565-1600	1565-1585	585	705	840	2053.33	2464.00
1700	ARXFSL170 (L or R)	1665-1700	1665-1685	585	705	940	2066.67	2480.00
1800	ARXFSL180 (L or R)	1765-1800	1765-1785	585	705	1040	2163.33	2596.00

This product is handed – please choose L for Left and R for Right when ordering. Please Note: To order an eyelet handle, add E to the end of the code, followed by handing (L or R) e.g. ARXFSL100EL / ARXFSL100ER. Please Note: Images are for illustrative purposes only. Please refer to the installation guide when fitting the product.

SIDE PANEL				
Size	Code	Adjustment Min-Max	Price £ Exc. VAT	Price £ Inc. VAT
760	ARXFSPSL76	730-750	575.00	690.00
800	ARXFSPSL80	770-790	618.33	742.00
900	ARXFSPSL90	870-890	702.50	843.00
1000	ARXFSPSL100	970-990	815.83	979.00

ADDITIONAL SUPPORT BAR				
Size	Code	Price £ Exc. VAT	Price £ Inc. VAT	
1000	ARXFSL90DEG	150.83	181.00	

Alternative support option (90° bar) - page 8 shows the image of the 90° support bar



Sliding Door with Eyelet Handle

Select Door

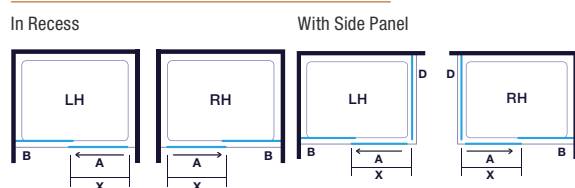

A: Moving Panel
B: Fixed Panel
X: Door Opening

Please Note: If fitting the eyelet handle, please consider the direction of your shower head.

Select Handle



To order an eyelet handle, add E to the end of the code, followed by handing (L or R). e.g. ARXFSL100EL / ARXFSL100ER

Please Note: If fitting the eyelet handle, please consider the direction of your shower head. Alternative 1000mm, 90° support bar available. Code ARXFSL90DEG.





Sliding Door with Side Panel shown as Right Hand (R) - Shown in Chrome



LEVEL25^{SR}

Match our ARYSTO X enclosures with our Level25-SR slip resistant trays - perfect for all ages.



SLIDING DOOR - NEW COLOURS

Features

- » Ultra frameless.
- » Self cleaning anti-jump rollers. Infographic can be found on page 7.
- » Eyelet handle available.
- » Wetroom compatible.
- » Concealed fixings.
- » Fixed front panel maximises functionality with a full-length towel rail handle, while the sliding door creates an exceptionally wide entry opening.
- » Now available in four new colours.

SLIDING DOOR

Size	Code	Adjustment Min-Max	Fully Opened	Fully Closed	Distance to Support Bar X	Brushed Nickel (BN)		Matt Black (MB)	
						Price £ Exc. VAT	Price £ Inc. VAT	Price £ Exc. VAT	Price £ Inc. VAT
1200	ARXFSL120 (L or R)	1150-1170	645	1140	560-580	2003.33	2404.00	1915.83	2299.00
1400	ARXFSL140 (L or R)	1350-1370	745	1340	660-680	2247.50	2697.00	2150.00	2580.00
1700	ARXFSL170 (L or R)	1650-1670	1045	1640	960-980	2376.67	2852.00	2273.33	2728.00

Please Note: To order an eyelet handle, add E to the end of the code, followed by handing (L or R) e.g. ARXFSL100SWEL / ARXFSL100SWER. Please Note: Images are for illustrative purposes only. Please refer to the installation guide when fitting the product. Alternative support option (90° bar) - shown on page 8.

SIDE PANEL

Size	Code	Adjustment Min-Max	Brushed Nickel (BN)		Matt Black (MB)	
			Price £ Exc. VAT	Price £ Inc. VAT	Price £ Exc. VAT	Price £ Inc. VAT
800	ARXFSPSL80	770-790	711.67	854.00	680.83	817.00
900	ARXFSPSL90	870-890	808.33	970.00	773.33	928.00

ADDITIONAL SUPPORT BAR

Size	Code	Brushed Nickel (BN)		Matt Black (MB)	
		Price £ Exc. VAT	Price £ Inc. VAT	Price £ Exc. VAT	Price £ Inc. VAT
1000	ARXFSL90DEG	174.17	209.00	166.67	200.00

Colour Finishes; Express Yourself

When ordering your door please use the correct code to the size required. Then add your handing followed by the colour code you need.

Example: ARXFSL120 is the standard chrome code add **MB** for Matt Black, **BBR** for Brushed Brass, **BN** for Brushed Nickel, or **BGM** for Brushed Gun Metal.

Example: ARXFSL120 + Handing (L or R) + MB (Matt Black) = ARXFSL120R-MB. For Eyelet handle add E to code. E.G. ARXFSEL120R-MB.

Chrome option is your standard code.



Select Door

In Recess

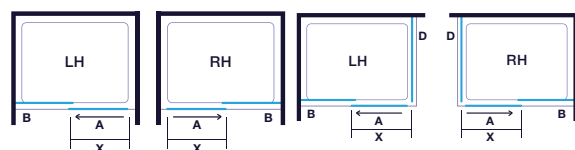

A: Moving Panel

B: Fixed Panel

X: Door Opening

Please Note: If fitting the eyelet handle, please consider the direction of your shower head.

Select Handle



To order an eyelet handle, add E to the end of the code, followed by handing (L or R). e.g. ARXFSL100EL / ARXFSL100ER

Please Note: If fitting the eyelet handle, please consider the direction of your shower head. Alternative 1000mm, 90° support bar available. Code ARXFSL90DEG.

NEW!

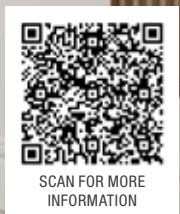

SCAN FOR MORE INFORMATION

Sliding Door in Recess shown as Left Hand (L) - Shown in Brushed Brass



LEVEL25^{SR}

Match our ARYSTO X enclosures with our Level25-SR slip resistant trays - perfect for all ages.

MERLYN will donate £25 from the sale of each ARYSTO X to the  pink ribbon foundation



WETROOM SLIDING DOOR - CHROME ONLY

Features

- » Ultra frameless.
- » Self cleaning anti-jump rollers.
- » Eyelet handle available.
- » Wetroom compatible.
- » Concealed fixings.
- » Fixed front panel maximises functionality with a full-length towel rail handle, while the sliding door creates an exceptionally wide entry opening.
- » Now available in four new colours.

WETROOM PANEL							
Size	Code	Adjustment Min-Max	Fully Opened	Fully Closed	Distance to Support Bar X	Price £ Exc. VAT	Price £ Inc. VAT
1000	ARXFSL100SW (L or R)	950-970	545	940	460-480	1791.67	2150.00
1100	ARXFSL110SW (L or R)	1050-1070	595	1040	510-530	1791.67	2150.00
1200	ARXFSL120SW (L or R)	1150-1170	645	1140	560-580	1798.33	2158.00
1300	ARXFSL130SW (L or R)	1250-1270	695	1240	610-630	1871.67	2246.00
1400	ARXFSL140SW (L or R)	1350-1370	745	1340	660-680	2010.83	2413.00
1500	ARXFSL150SW (L or R)	1450-1470	845	1440	760-780	2090.00	2508.00
1600	ARXFSL160SW (L or R)	1550-1570	945	1540	860-880	2110.00	2532.00
1700	ARXFSL170SW (L or R)	1650-1670	1045	1640	960-980	2124.17	2549.00
1800	ARXFSL180SW (L or R)	1750-1770	1145	1740	1060-1080	2220.83	2665.00

Please Note: To order an eyelet handle, add E to the end of the code, followed by handing (L or R) e.g. ARXFSL100SWEL / ARXFSL100SWER. Please Note: Images are for illustrative purposes only. Please refer to the installation guide when fitting the product. Alternative support option (90° bar) - shown on page 8.

ARYSTO X ROLLER TECHNOLOGY

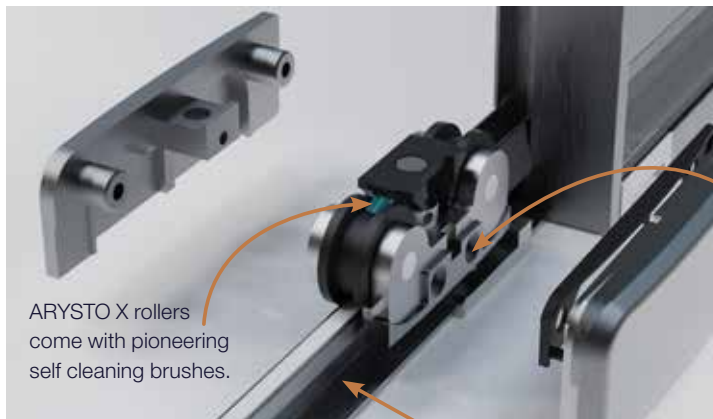

ARYSTO X rollers come with pioneering self cleaning brushes.

Built-in anti-jump with cushioned, silent closing.

Experience effortless rolling with our friction-free track technology.

Select Door

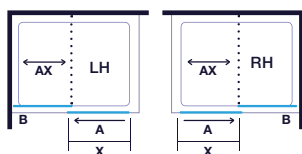

A: Moving Panel
 B: Fixed Panel
 C: Support Bar
 X: Distance to support bar (only on Wetroom Panels)
 Please Note: If fitting the eyelet handle, please consider the direction of your shower head.

Select Handle



To order an eyelet handle, add E to the end of the code, followed by handing (L or R). e.g. ARXFSL100EL / ARXFSL100ER

Please Note: If fitting the eyelet handle, please consider the direction of your shower head. Alternative 1000mm, 90° support bar available. Code ARXFSL90DEG.



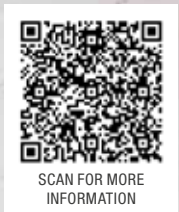
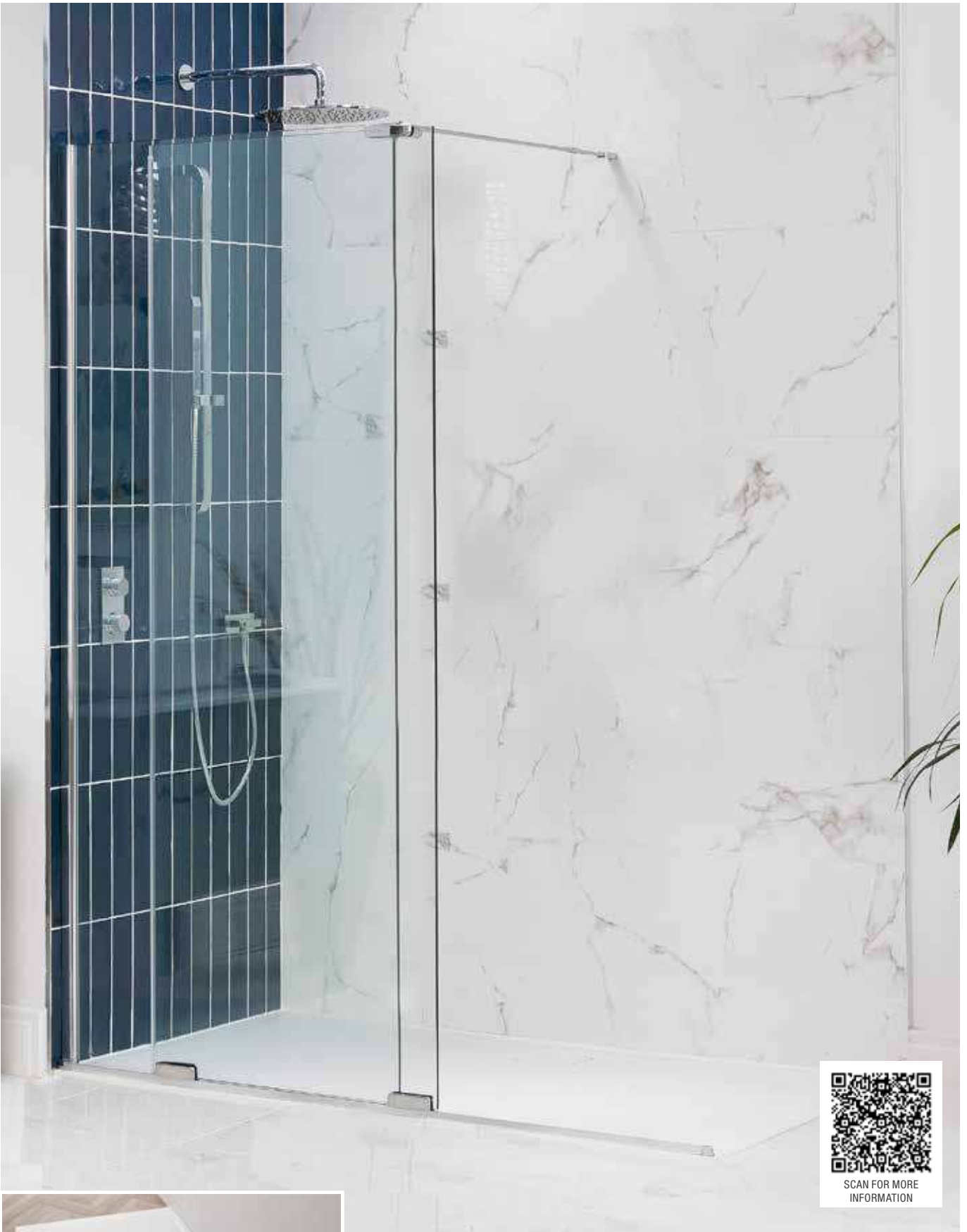

Wetroom Sliding Door shown as Left Hand (L) - Shown in Chrome

LEVEL25^{SR}

Match our ARYSTO X enclosures with our Level25-SR slip resistant trays - perfect for all ages.

MERLYN will donate
£25 from the sale of
each ARYSTO X to the
pink ribbon
Foundation



WETROOM SLIDING DOOR - NEW COLOURS

Features

- » Ultra frameless.
- » Self cleaning anti-jump rollers. Infographic can be found on page 7.
- » Eyelet handle available.
- » Wetroom compatible.
- » Concealed fixings.
- » Fixed front panel maximises functionality with a full-length towel rail handle, while the sliding door creates an exceptionally wide entry opening.
- » Now available in four new colours.

SLIDING DOOR						Brushed Nickel (BN) Brushed Brass (BBR) Brushed Gun Metal (BGM)	Matt Black (MB)			
Size	Code	Adjustment Min-Max	Fully Opened	Fully Closed	Distance to Support Bar X	Price £ Exc. VAT	Price £ Inc. VAT	Price £ Exc. VAT	Price £ Inc. VAT	
1200	ARXFSL120SW (L or R)	1150-1170	645	1140	560-580	2068.33	2482.00	1978.33	2374.00	
1400	ARXFSL140SW (L or R)	1350-1370	745	1340	660-680	2312.50	2775.00	2212.50	2655.00	
1700	ARXFSL170SW (L or R)	1650-1670	1045	1640	960-980	2443.33	2932.00	2336.67	2804.00	

Please Note: To order an eyelet handle, add E to the end of the code, followed by handing (L or R) e.g. ARXFSL100SWEL / ARXFSL100SWER. Please Note: Images are for illustrative purposes only. Please refer to the installation guide when fitting the product. Alternative support option (90° bar) - shown on page 8.

Colour Finishes; Express Yourself

When ordering your door please use the correct code to the size required. Then add your handing followed by the colour code you need.

Example: ARXFSL120 is the standard chrome code add **MB** for Matt Black, **BBR** for Brushed Brass, **BN** for Brushed Nickel, or **BGM** for Brushed Gun Metal.

Example: ARXFSL120SW + Handing (L or R) + MB (Matt Black) = ARXFSL120SWR-MB. For Eyelet handle add E to code. E.G. ARXFSL120SWR-MB.

Chrome option is your standard code.



Select Door

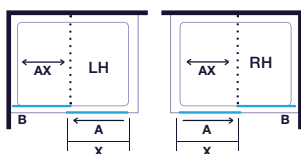

- A: Moving Panel
 - B: Fixed Panel
 - C: Support Bar
 - X: Distance to support bar (only on Wetroom Panels)
- Please Note: If fitting the eyelet handle, please consider the direction of your shower head.

Select Handle



To order an eyelet handle, add E to the end of the code, followed by handing (L or R). e.g. ARXFSL100EL / ARXFSL100ER

Please Note: If fitting the eyelet handle, please consider the direction of your shower head. Alternative 1000mm, 90° support bar available. Code ARXFSL90DEG.



NEW!



SCAN FOR MORE
INFORMATION

Wetroom Sliding Door shown as Left Hand (L) / Brushed Nickel



LEVEL25-SR

Match our ARYSTO X enclosures with our Level25-SR slip resistant trays - perfect for all ages.

MERLYN will donate
£25 from the sale of
each ARYSTO X to the
pink ribbon
Foundation

UP TO
2015
MM
HEIGHT
STANDARD RANGE

10^{MM}
GLASS
THICKNESS

MERSHIELD™
STAYCLEAR

LIFETIME
GUARANTEE

ARYSTO TEN

The stunning ARYSTO TEN Collection is the result of years of design and engineering research. This range showcases unique and stylish features, innovative design and engineering solutions like the AirGlyde Dual Track Rolling System.

These stunning and luxurious shower enclosures have been beautifully crafted using the highest quality materials.

Exquisitely designed, expertly manufactured, the ARYSTO TEN Collection is the next level.





Three Panel Sliding Door with Side Panel shown as Left Hand (L) - featuring Halo Handle and Halo Profiles

FREE

MERLYN Wiper with each complete purchase of an ARYSTO Ten Product!



THE SLIDING DOOR COLLECTION

Our superbly designed Sliding Doors have been precision engineered to effortlessly glide on our hidden AirGlyde dual track sliding system. Beautiful options such as our Halo Handle and Halo Profile make this a truly unique piece.





Two Panel Sliding Door with Side Panel shown as Left Hand (L)



TWO PANEL SLIDING DOOR IN RECESS

Features

- » Smooth flowing curves with crisp contemporary lines and frameless design details make this a true centrepiece for the bathroom.
- » Ultra smooth rolling action and soft close door - ARYSTO AirGlyde Dual Track system ensures it effortlessly glides open and closed.
- » Features such as Mershield Stayclear™ easy clean glass and fully concealed fixings make this enclosure easy clean.
- » Halo Handle and Profile (LED light) options available - the warm ambient glow takes this enclosure to the next level of luxury.

TWO PANEL SLIDING DOOR IN RECESS

Size	Code	Adjustment Min-Max	Door Opening X	Moving Panel A	Fixed Panel B	Price £ Exc. VAT	Price £ Inc. VAT
1000	GSR1000H (L or R)	960-990	370	528	430	1644.17	1973.00
1025	GSR1025H (L or R)	985-1015	370	528	455	1644.17	1973.00
1050	GSR1050H (L or R)	1010-1040	370	528	480	1644.17	1973.00
1075	GSR1075H (L or R)	1035-1065	370	528	505	1644.17	1973.00
1100	GSR1100H (L or R)	1060-1090	420	578	480	1644.17	1973.00
1125	GSR1125H (L or R)	1085-1115	420	578	505	1644.17	1973.00
1150	GSR1150H (L or R)	1110-1140	420	578	530	1644.17	1973.00
1175	GSR1175H (L or R)	1135-1165	420	578	555	1644.17	1973.00
1200	GSR2P1200H (L or R)	1160-1190	465	626	530	1580.00	1896.00
1400	GSR2P1400H (L or R)	1360-1390	566	723	635	1823.33	2188.00

This product is handed – please choose L for Left and R for Right when ordering. Please Note: Images are for illustrative purposes only. Please refer to the installation guide when fitting the product. Please Note: There is a minimum clearance of 100mm required above the shower enclosure to fix the top rail.

Select Handle

	Code	Price £ Exc. VAT	Price £ Inc. VAT
1. Standard Sliding Handle			
2. Halo Handle	GMSHH	253.33	304.00



Please clearly outline any additions to your order.

Select Halo Wall Profile our LED Lights

	Code	Price £ Exc. VAT	Price £ Inc. VAT
Fixed Panel Halo Profile	GMKLEDAC L or R	253.33	304.00
Side Panel Halo Profile	GMKLEDCC L or R	253.33	304.00
Closing Post	GMKLEDBC L or R	253.33	304.00

Select Door Handing



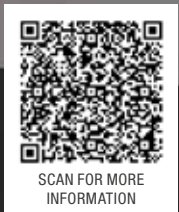

SCAN FOR MORE
INFORMATION

Two Panel Sliding Door in Recess shown as Left Hand (L)



LEVEL25

Match our ARYSTO 10 enclosures with our Level25 trays for that luxurious look.

Trays ...



TWO PANEL SLIDING DOOR WITH SIDE PANEL

Features

- » Smooth flowing curves with crisp contemporary lines and frameless design details make this a true centrepiece for the bathroom.
- » Ultra smooth rolling action and soft close door - ARYSTO AirGlyde Dual Track system ensures it effortlessly glides open and closed.
- » Features such as Mershield Stayclear™ easy clean glass and fully concealed fixings make this enclosure easy clean.
- » Halo Handle and Profile (LED light) options available - the warm ambient glow takes this enclosure to the next level of luxury.

TWO PANEL SLIDING DOOR WITH SIDE PANEL							
Size	Code	Adjustment Min-Max	Door Opening X	Moving Panel A	Fixed Panel B	Price £ Exc. VAT	Price £ Inc. VAT
1000	GSC1000H (L or R)	983-998	380	528	430	1644.17	1973.00
1025	GSC1025H (L or R)	1008-1023	380	528	455	1644.17	1973.00
1050	GSC1050H (L or R)	1033-1048	380	528	480	1644.17	1973.00
1075	GSC1075H (L or R)	1058-1073	380	528	505	1644.17	1973.00
1100	GSC1100H (L or R)	1083-1098	430	578	480	1644.17	1973.00
1125	GSC1125H (L or R)	1108-1123	430	578	505	1644.17	1973.00
1150	GSC1150H (L or R)	1133-1148	430	578	530	1644.17	1973.00
1175	GSC1175H (L or R)	1158-1173	430	578	555	1644.17	1973.00
1200	GSC2P1200H (L or R)	1183-1198	473	626	530	1650.83	1981.00
1400	GSC2P1400H (L or R)	1383-1398	573	723	635	1905.00	2286.00

This product is handed – please choose L for Left and R for Right when ordering.

SIDE PANEL				
Size	Code	Adjustment Min-Max	Price £ Exc. VAT	Price £ Inc. VAT
700	GMSSP700C	670-685	518.33	622.00
760	GMSSP760C	730-745	545.00	654.00
800	GMSSP800C	770-785	586.67	704.00
900	GMSSP900C	870-885	665.83	799.00
1000	GMSSP1000C	970-985	772.50	927.00

For wetroom / grout line adjustment please contact Customer Service. Please Note: Images are for illustrative purposes only. Please refer to the installation guide when fitting the product. Please Note: There is a minimum clearance of 100mm required above the shower enclosure to fix the top rail

Select Handle

	Code	Price £ Exc. VAT	Price £ Inc. VAT
1. Standard Sliding Handle			
2. Halo Handle	GMSHH	253.33	304.00



Please clearly outline any additions to your order.

Select Halo Wall Profile our LED Lights

	Code	Price £ Exc. VAT	Price £ Inc. VAT
Fixed Panel Halo Profile	GMKLEDAC L or R	253.33	304.00
Side Panel Halo Profile	GMKLEDCC L or R	253.33	304.00
Closing Post	GMKLEDBC L or R	253.33	304.00

Select Door Handing



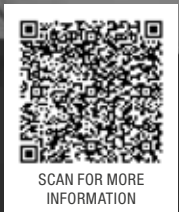

SCAN FOR MORE
INFORMATION

Two Panel Sliding Door with Side Panel shown as Left Hand (L)



LEVEL25

Match our ARYSTO 10 enclosures with our Level25 trays for that luxurious look.

Trays ...



THREE PANEL SLIDING DOOR IN RECESS

Features

- » Smooth flowing curves with crisp contemporary lines and frameless design details make this a true centrepiece for the bathroom.
- » Ultra smooth rolling action and soft close door - ARYSTO AirGlyde Dual Track system ensures it effortlessly glides open and closed.
- » Features such as Mershield Stayclear™ easy clean glass and fully concealed fixings make this enclosure easy clean.
- » Halo Handle and Profile (LED light) options available - the warm ambient glow takes this enclosure to the next level of luxury.

THREE PANEL SLIDING DOOR IN RECESS								
Size	Code	Adjustment Min-Max	Door Opening X	Moving Panel A	Fixed Panel B	Fixed Panel C	Price £ Exc. VAT	Price £ Inc. VAT
1200	GSR1200H (L or R)	1160-1190	450	605	505	70	1650.83	1981.00
1225	GSR1225H (L or R)	1185-1215	450	605	505	95	1876.67	2252.00
1250	GSR1250H (L or R)	1210-1240	450	605	505	120	1883.33	2260.00
1275	GSR1275H (L or R)	1235-1265	450	605	505	145	1895.00	2274.00
1300	GSR1300H (L or R)	1260-1290	450	605	505	170	1905.00	2286.00
1325	GSR1325H (L or R)	1285-1315	450	605	505	195	1905.00	2286.00
1350	GSR1350H (L or R)	1310-1340	450	605	505	220	1905.00	2286.00
1375	GSR1375H (L or R)	1335-1365	450	605	505	245	1905.00	2286.00
1400	GSR1400H (L or R)	1360-1390	450	605	505	270	1905.00	2286.00
1425	GSR1425H (L or R)	1385-1415	450	605	505	295	1917.50	2301.00
1450	GSR1450H (L or R)	1410-1440	450	605	505	320	1917.50	2301.00
1475	GSR1475H (L or R)	1435-1465	450	605	505	345	1921.67	2306.00
1500	GSR1500H (L or R)	1460-1490	600	755	655	70	1921.67	2306.00
1525	GSR1525H (L or R)	1485-1515	600	755	655	95	1985.83	2383.00
1550	GSR1550H (L or R)	1510-1540	600	755	655	120	1985.83	2383.00
1575	GSR1575H (L or R)	1535-1565	600	755	655	145	1990.00	2388.00
1600	GSR1600H (L or R)	1560-1590	600	755	655	170	1990.00	2388.00
1625	GSR1625H (L or R)	1585-1615	600	755	655	195	2088.33	2506.00
1650	GSR1650H (L or R)	1610-1640	600	755	655	220	2092.50	2511.00
1675	GSR1675H (L or R)	1635-1665	600	755	655	245	2104.17	2525.00
1700	GSR1700H (L or R)	1660-1690	600	755	655	270	2140.83	2569.00
1725	GSR1725H (L or R)	1685-1715	600	755	655	295	2102.50	2523.00
1750	GSR1750H (L or R)	1710-1740	600	755	655	320	2102.50	2523.00
1775	GSR1775H (L or R)	1735-1765	600	755	655	345	2102.50	2523.00
1800	GSR1800H (L or R)	1760-1790	600	755	655	370	2102.50	2523.00

This product is handed – please choose L for Left and R for Right when ordering.

Select Handle

	Code	Price £ Exc. VAT	Price £ Inc. VAT
1. Standard Sliding Handle			
2. Halo Handle	GMSHH	253.33	304.00



Please Note: There is a minimum clearance of 100mm required above the shower enclosure to fix the top rail. Please clearly outline any additions to your order. Please Note: Images are for illustrative purposes only. Please refer to the installation guide when fitting the product

Select Halo Wall Profile our LED Lights

	Code	Price £ Exc. VAT	Price £ Inc. VAT
Fixed Panel Halo Profile	GMKLEDAC L or R	253.33	304.00
Side Panel Halo Profile	GMKLEDCC L or R	253.33	304.00
Closing Post	GMKLEDBC L or R	253.33	304.00

Select Door Handing

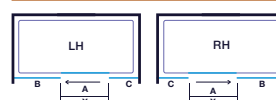

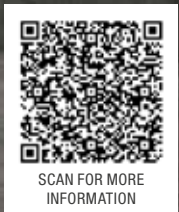

Three Panel Sliding Door in Recess with Halo Handle and Profiles shown as Left Hand (L)



LEVEL25

Match our ARYSTO 10 enclosures with our Level25 trays for that luxurious look.

Trays ...



THREE PANEL SLIDING DOOR WITH SIDE PANEL

Features

- » Smooth flowing curves with crisp contemporary lines and frameless design details make this a true centrepiece for the bathroom.
- » Ultra smooth rolling action and soft close door - ARYSTO AirGlyde Dual Track system ensures it effortlessly glides open and closed.
- » Features such as Mershield Stayclear™ easy clean glass and fully concealed fixings make this enclosure easy clean.
- » Halo Handle and Profile (LED light) options available - the warm ambient glow takes this enclosure to the next level of luxury.

THREE PANEL SLIDING DOOR WITH SIDE PANEL

Size	Code	Adjustment Min-Max	Door Opening X	Moving Panel A	Fixed Pane B	Fixed Panel C	Price £ Exc. VAT	Price £ Inc. VAT
1200	GSC1200H (L or R)	1168-1183	450	605	505	70	1650.83	1981.00
1225	GSC1225H (L or R)	1193-1208	450	605	505	95	1876.67	2252.00
1250	GSC1250H (L or R)	1218-1233	450	605	505	120	1883.33	2260.00
1275	GSC1275H (L or R)	1243-1258	450	605	505	145	1895.00	2274.00
1300	GSC1300H (L or R)	1268-1283	450	605	505	170	1905.00	2286.00
1325	GSC1325H (L or R)	1293-1308	450	605	505	195	1905.00	2286.00
1350	GSC1350H (L or R)	1318-1333	450	605	505	220	1905.00	2286.00
1375	GSC1375H (L or R)	1343-1358	450	605	505	245	1905.00	2286.00
1400	GSC1400H (L or R)	1368-1383	450	605	505	270	1905.00	2286.00
1425	GSC1425H (L or R)	1393-1408	450	605	505	295	1917.50	2301.00
1450	GSC1450H (L or R)	1418-1433	450	605	505	320	1917.50	2301.00
1475	GSC1475H (L or R)	1443-1458	450	605	505	345	1921.67	2306.00
1500	GSC1500H (L or R)	1468-1483	600	755	655	70	1921.67	2306.00
1525	GSC1525H (L or R)	1493-1508	600	755	655	95	1985.83	2383.00
1550	GSC1550H (L or R)	1518-1533	600	755	655	120	1985.83	2383.00
1575	GSC1575H (L or R)	1543-1558	600	755	655	145	1990.00	2388.00
1600	GSC1600H (L or R)	1568-1583	600	755	655	170	1990.00	2388.00
1625	GSC1625H (L or R)	1593-1608	600	755	655	195	2088.33	2506.00
1650	GSC1650H (L or R)	1618-1633	600	755	655	220	2092.50	2511.00
1675	GSC1675H (L or R)	1643-1658	600	755	655	245	2104.17	2525.00
1700	GSC1700H (L or R)	1668-1683	600	755	655	270	2140.83	2569.00
1725	GSC1725H (L or R)	1693-1708	600	755	655	295	2196.67	2636.00
1750	GSC1750H (L or R)	1718-1733	600	755	655	320	2196.67	2636.00
1775	GSC1775H (L or R)	1743-1758	600	755	655	345	2196.67	2636.00
1800	GSC1800H (L or R)	1768-1783	600	755	655	370	2196.67	2636.00

This product is handed – please choose L for Left and R for Right when ordering.

SIDE PANEL

Size	Code	Adjustment Min-Max	Price £ Exc. VAT	Price £ Inc. VAT
700	GMSSP700C	670-685	518.33	622.00
760	GMSSP760C	730-745	545.00	654.00
800	GMSSP800C	770-785	586.67	704.00
900	GMSSP900C	870-885	665.83	799.00
1000	GMSSP1000C	970-985	772.50	927.00

Select Handle

	Code	Price £ Exc. VAT	Price £ Inc. VAT
1. Standard Sliding Handle			
2. Halo Handle	GMSHH	253.33	304.00



Please Note: There is a minimum clearance of 100mm required above the shower enclosure to fix the top rail. Please clearly outline any additions to your order. Please Note: Images are for illustrative purposes only. Please refer to the installation guide when fitting the product.

Select Halo Wall Profile our LED Lights

	Code	Price £ Exc. VAT	Price £ Inc. VAT
Fixed Panel Halo Profile	GMKLEDAC L or R	253.33	304.00
Side Panel Halo Profile	GMKLEDCC L or R	253.33	304.00
Closing Post	GMKLEDBC L or R	253.33	304.00

Select Door Handing

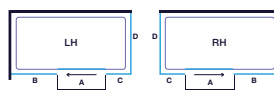

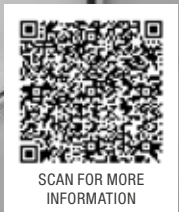

SCAN FOR MORE
INFORMATION

Three Panel Sliding Door with Side Panel shown as Left Hand (L)



LEVEL25

Match our ARYSTO 10 enclosures with our Level25 trays for that luxurious look.

Trays ...



ONE DOOR QUADRANT

Features

- » Smooth flowing curves with crisp contemporary lines and frameless design details make this a true centrepiece for the bathroom.
- » Ultra smooth rolling action and soft close door - ARYSTO AirGlyde Dual Track system ensures it effortlessly glides open and closed.
- » Features such as Mershield Stayclear™ easy clean glass and fully concealed fixings make this enclosure easy clean.

ONE DOOR QUADRANT								
Size	Code	Adjustment Min-Max	Door Opening X	Moving Panel A	Fixed Panel B	Fixed Panel C	Price £ Exc. VAT	Price £ Inc. VAT
900	GSQ90H (L or R)	870-885	460	615	535	345	2320.00	2784.00
1000	GSQ10H (L or R)	970-985	460	615	635	445	2456.67	2948.00

ONE DOOR OFFSET QUADRANT								
Size	Code	Adjustment Min-Max	Door Opening X	Panel A Moving Panel	Panel B Fixed Panel	Panel C Fixed Panel	Price £ Exc. VAT	Price £ Inc. VAT
1000 x 800	GSQ1080H (L or R)	970-985/ 770-785	460	615	485	445	2388.33	2866.00
1200 x 800	GSQ1280H (L or R)	1170-1185/ 770-785	460	615	485	645	2565.83	3079.00
1200 x 900	GSQ1290H (L or R)	1170-1185/ 870-885	460	615	535	645	2592.50	3111.00
1400 x 800	GSQ1480H (L or R)	1370-1385/ 770-785	460	615	485	845	2729.17	3275.00

This product is handed – please choose L for Left and R for Right when ordering. For wetroom / grout line adjustment please contact Customer Service.



One Door Quadrant (L)

Select Handle

- Standard Sliding Handle
- Slim Handle

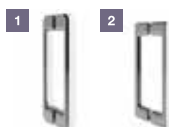

Please Note: Images are for illustrative purposes only. Please refer to the installation guide when fitting the product. Please clearly outline any additions to your order.

Select Door Handing

One door quadrant

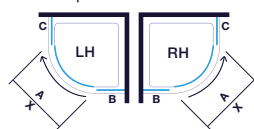

One door offset quadrant



Select Halo Wall Profile

Code	Price £ Exc. VAT	Price £ Inc. VAT
Fixed Panel Halo Profile*	GMKLEDAC L or R 253.33	304.00

*Must order 1 Profile for each side if required.



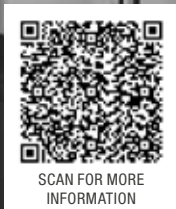

SCAN FOR MORE INFORMATION

One Door Offset Quadrant shown as Right Hand (R)



LEVEL25

Match our ARYSTO 10 enclosures with our Level25 trays for that luxurious look.

Trays...

FREE

MERLYN Wiper with each complete purchase of an ARYSTO Ten Product! (chrome enclosures only).



THE HINGE DOOR COLLECTION

Elevate your bathroom with the ultimate statement of style and refinement - the ARYSTO TEN Hinge Collection – the most superior range within the ARYSTO family.

Meticulously crafted with unparalleled attention to detail, this frameless design features stunning hinges and opulent 10mm glass.

Choose from a selection of high-quality PVD colour finishes, brushed brass, matt black, brushed stainless steel, or brushed bronze, each providing a unique character and style that will elevate your bathroom to new heights of sophistication and indulgence.



Our standard polished chrome is also available without a PVD coating.

Colour Options...





What is PVD?

PVD is one of the most durable and luxurious finishes available ensuring it will last the test of time.

ARYSTO TEN hinge & Inline in colour is a lead time product. - Please contact customer service for more information



HINGE DOOR & INLINE PANEL IN RECESS

Features

- » The ultimate in frameless design with beautifully designed hinges and luxury 10mm glass - this enclosure is a true show stopper.
- » Designer hinges highly engineered to ensure smooth and solid opening and closing.
- » Minimal framework and Mershield Stayclear™ easy clean glass minimises cleaning time.
- » Inline Panel supplied with a straight/angled bracing bar.
- » Four colour options available - chrome comes as standard.
- » Bespoke options available.

HINGE DOOR & INLINE PANEL IN RECESS						CHROME PRICING		COLOUR PRICING (LONGER LEAD TIME)	
Size	Code	Adjustment Min-Max	Door Opening X	Moving Panel A	Hinged Panel B	Price £ Exc. VAT	Price £ Inc. VAT	Price £ Exc. VAT	Price £ Inc. VAT
900	GHA900H (L or R)	865-890	550	600	251	1565.83	1879.00	2095.00	2514.00
925	GHA925H (L or R)	890-915	575	625	251	1705.83	2047.00	2282.50	2739.00
950	GHA950H (L or R)	915-940	600	650	251	1705.83	2047.00	2282.50	2739.00
975	GHA975H (L or R)	940-965	625	675	251	1705.83	2047.00	2282.50	2739.00
1000	GHA1000H (L or R)	965-990	650	700	251	1705.83	2047.00	2282.50	2739.00
1025	GHA1025H (L or R)	990-1015	675	725	251	1740.00	2088.00	2327.50	2793.00
1050	GHA1050H (L or R)	1015-1040	700	750	251	1740.00	2088.00	2327.50	2793.00
1075	GHA1075H (L or R)	1040-1065	725	775	251	1740.00	2088.00	2327.50	2793.00
1100	GHA1100H (L or R)	1065-1090	650	700	351	1740.00	2088.00	2327.50	2793.00
1125	GHA1125H (L or R)	1090-1115	675	725	351	1805.00	2166.00	2415.00	2898.00
1150	GHA1150H (L or R)	1115-1140	700	750	351	1805.00	2166.00	2414.17	2897.00
1175	GHA1175H (L or R)	1140-1165	725	775	351	1805.00	2166.00	2415.00	2898.00
1200	GHA1200H (L or R)	1165-1190	650	700	451	1805.00	2166.00	2414.17	2897.00
1225	GHA1225H (L or R)	1190-1215	675	725	451	1885.83	2263.00	2522.50	3027.00
1250	GHA1250H (L or R)	1215-1240	700	750	451	1885.83	2263.00	2522.50	3027.00
1275	GHA1275H (L or R)	1240-1265	725	775	451	1885.83	2263.00	2522.50	3027.00
1300	GHA1300H (L or R)	1265-1290	750	800	451	1885.83	2263.00	2522.50	3027.00
1325	GHA1325H (L or R)	1290-1315	775	825	451	1905.00	2286.00	2548.33	3058.00
1350	GHA1350H (L or R)	1315-1340	800	850	451	1905.00	2286.00	2548.33	3058.00
1375	GHA1375H (L or R)	1340-1365	825	875	451	1905.00	2286.00	2548.33	3058.00
1400	GHA1400H (L or R)	1365-1390	750	800	551	1905.00	2286.00	2548.33	3058.00

Chrome is handed – Please choose L for Left and R for Right when ordering. Please clearly outline any additions to your order. Please Note: Images are for illustrative purposes only. Please refer to the installation guide when fitting the product. Please Note: For wetroom / grout line adjustment please contact Customer Service. **Colour is reversible.**

Select Handle

1. Standard Hinge Handle
2. Traditional Handle
3. Colour Handle

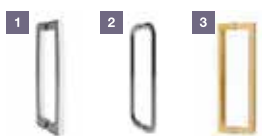

Pic 1 & 2 shows standard & traditional handles only available in a chrome finish. Pic 3 shows colour handle.

Select Door Handing - Colour is reversible

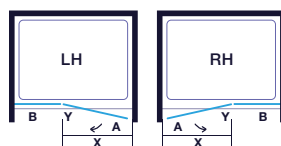

Colour Finishes; Express Yourself

When ordering your door please use the correct code to the size required. Then add the colour code you need.

Example: GHA900H is the standard chrome code add **MB** for Matt Black, **BBS** for Brushed Stainless Steel, **BBR** for Brushed Brass, or **BBZ** for Brushed Bronze.

Example: GHA900H + MB (Matt Black) = GHA900H-MB.

Chrome option is your standard code.



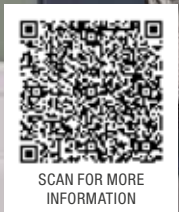

Hinge Door & Inline Panel shown in Recess as Right Hand (R) - Shown in Brushed Brass



TRUESTONE®

Match our ARYSTO 10 enclosures with our Truestone trays for that all inspiring look and feel.

Trays...



HINGE DOOR & INLINE PANEL WITH SIDE PANEL

Features

- » The ultimate in frameless design with beautifully designed hinges and luxury 10mm glass - this enclosure is a true show stopper.
- » Designer hinges highly engineered to ensure smooth and solid opening and closing.
- » Minimal framework and Mershield Stayclear™ easy clean glass minimises cleaning time.
- » Inline Panel supplied with a straight/angled bracing bar.
- » Four colour options available - chrome comes as standard.
- » Bespoke options available.

HINGE DOOR & INLINE PANEL						CHROME PRICING		COLOUR PRICING (LONGER LEAD TIME)	
Size	Code	Adjustment Min-Max	Door Opening X	Moving Panel A	Hinged Panel B	Price £ Exc. VAT	Price £ Inc. VAT	Price £ Exc. VAT	Price £ Inc. VAT
900	GHC900H (L or R)	865-880	565	600	226	1787.50	2145.00	2391.67	2870.00
1000	GHC1000H (L or R)	965-980	665	700	226	1817.50	2181.00	2431.67	2918.00
1100	GHC1100H (L or R)	1065-1080	665	700	326	1831.67	2198.00	2450.83	2941.00
1200	GHC1200H (L or R)	1165-1180	665	700	426	1848.33	2218.00	2472.50	2967.00
1300	GHC1300H (L or R)	1265-1280	765	800	426	1923.33	2308.00	2572.50	3087.00
1400	GHC1400H (L or R)	1365-1380	765	800	526	1951.67	2342.00	2610.83	3133.00

Chrome is handed – please choose L for Left and R for Right when ordering. Please clearly outline any additions to your order. **Please Note:** for colour take off 2mm for front panel adjustments. Colour is reversible.

SIDE PANEL				CHROME PRICING		COLOUR PRICING (LONGER LEAD TIME)	
Size	Code	Adjustment Min-Max	Side Panel D	Price £ Exc. VAT	Price £ Inc. VAT	Price £ Exc. VAT	Price £ Inc. VAT
700	GHSA700H	665-680	645	380.00	456.00	508.33	610.00
760	GHSA760H	725-740	705	390.83	469.00	522.50	627.00
800	GHSA800H	765-780	745	400.83	481.00	535.83	643.00
900	GHSA900H	865-880	845	423.33	508.00	566.67	680.00
1000	GHSA1000H	965-980	945	464.17	557.00	621.67	746.00

Side Panel is reversible. **Please Note:** Images are for illustrative purposes only. Please refer to the installation guide when fitting the product. **Please Note:** for colour take off 2mm for side panel adjustments.

Select Handle

1. Standard Hinge Handle
2. Traditional Handle
3. Colour Handle

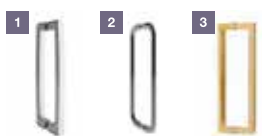

Pic 1 & 2 shows standard & traditional handles only available in a chrome finish. Pic 3 shows colour handle.

Select Door Handing - Colour is reversible

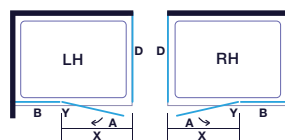

Colour Finishes; Express Yourself

When ordering your door please use the correct code to the size required. Then add the colour code you need.

Example: GHC900H is the standard chrome code add **MB** for Matt Black, **BBS** for Brushed Stainless Steel, **BBR** for Brushed Brass, or **BBZ** for Brushed Bronze.

Example: GHC900H + MB (Matt Black) = GHC900H-MB.

Chrome option is your standard code.





Hinge Door & Inline Panel with Side Panel shown as Left Hand (L) - Shown in Matt Black



 TRUESTONE®

Match our ARYSTO 10 enclosures with our Truestone trays for that all inspiring look and feel.

Trays...



HINGE DOOR & TWO INLINE PANELS IN RECESS

Features

- » The ultimate in frameless design with beautifully designed hinges and luxury 10mm glass - this enclosure is a true show stopper.
- » Designer hinges highly engineered to ensure smooth and solid opening and closing.
- » Minimal framework and Mershield Stayclear™ easy clean glass minimises cleaning time.
- » Inline Panel supplied with a straight/angled bracing bar.
- » Four colour options available - chrome comes as standard.
- » Bespoke options available.

HINGE DOOR & TWO INLINE PANELS IN RECESS							CHROME PRICING		COLOUR PRICING (LONGER LEAD TIME)	
Size	Code	Adjustment Min-Max	Door Opening X	Panel A Moving Panel	Panel B Hinged Panel	Panel C Inline Panel	Price £ Exc. VAT	Price £ Inc. VAT	Price £ Exc. VAT	Price £ Inc. VAT
1100	GHB1100H (L or R)	1060-1090	565	600	251	192	1902.50	2283.00	2545.83	3055.00
1125	GHB1125H (L or R)	1085-1115	590	625	251	192	1930.00	2316.00	2581.67	3098.00
1150	GHB1150H (L or R)	1110-1140	615	650	251	192	1930.00	2316.00	2581.67	3098.00
1175	GHB1175H (L or R)	1135-1165	640	675	251	192	1930.00	2316.00	2581.67	3098.00
1200	GHB1200H (L or R)	1160-1190	565	600	251	292	1930.00	2316.00	2581.67	3098.00
1225	GHB1225H (L or R)	1185-1215	590	625	251	292	2007.50	2409.00	2685.83	3223.00
1250	GHB1250H (L or R)	1210-1240	615	650	251	292	2007.50	2409.00	2685.83	3223.00
1275	GHB1275H (L or R)	1235-1265	640	675	251	292	2007.50	2409.00	2685.83	3223.00
1300	GHB1300H (L or R)	1260-1290	565	600	251	392	2007.50	2409.00	2685.83	3223.00
1325	GHB1325H (L or R)	1285-1315	590	625	251	392	2070.00	2484.00	2769.17	3323.00
1350	GHB1350H (L or R)	1310-1340	615	650	251	392	2070.00	2484.00	2769.17	3323.00
1375	GHB1375H (L or R)	1335-1365	640	675	251	392	2070.00	2484.00	2769.17	3323.00
1400	GHB1400H (L or R)	1360-1390	665	700	251	392	2070.00	2484.00	2769.17	3323.00
1425	GHB1425H (L or R)	1385-1415	690	725	251	392	2099.17	2519.00	2809.17	3371.00
1450	GHB1450H (L or R)	1410-1440	715	750	251	392	2099.17	2519.00	2809.17	3371.00
1475	GHB1475H (L or R)	1435-1465	740	775	251	392	2099.17	2519.00	2809.17	3371.00
1500	GHB1500H (L or R)	1460-1490	665	700	351	392	2099.17	2519.00	2809.17	3371.00
1525	GHB1525H (L or R)	1485-1515	690	725	351	392	2148.33	2578.00	2874.17	3449.00
1550	GHB1550H (L or R)	1510-1540	715	750	351	392	2148.33	2578.00	2874.17	3449.00
1575	GHB1575H (L or R)	1535-1565	740	775	351	392	2148.33	2578.00	2874.17	3449.00
1600	GHB1600H (L or R)	1560-1590	665	700	451	392	2148.33	2578.00	2874.17	3449.00
1625	GHB1625H (L or R)	1585-1615	690	725	451	392	2156.67	2588.00	2885.00	3462.00
1650	GHB1650H (L or R)	1610-1640	715	750	451	392	2156.67	2588.00	2885.00	3462.00
1675	GHB1675H (L or R)	1635-1665	740	775	451	392	2156.67	2588.00	2885.00	3462.00
1700	GHB1700H (L or R)	1660-1690	665	700	451	492	2156.67	2588.00	2885.00	3462.00
1725	GHB1725H (L or R)	1685-1715	690	725	451	492	2198.33	2638.00	2941.67	3530.00
1750	GHB1750H (L or R)	1710-1740	715	750	451	492	2198.33	2638.00	2941.67	3530.00
1775	GHB1775H (L or R)	1735-1765	740	775	451	492	2198.33	2638.00	2941.67	3530.00
1800	GHB1800H (L or R)	1760-1790	765	800	451	492	2198.33	2638.00	2941.67	3530.00
1825	GHB1825H (L or R)	1785-1815	790	825	451	492	2225.83	2671.00	2977.50	3573.00
1850	GHB1850H (L or R)	1810-1840	815	850	451	492	2225.83	2671.00	2977.50	3573.00
1875	GHB1875H (L or R)	1835-1865	840	875	451	492	2225.83	2671.00	2977.50	3573.00
1900	GHB1900H (L or R)	1860-1890	765	800	451	592	2225.83	2671.00	2977.50	3573.00

Chrome is handed – please choose L for Left and R for Right when ordering. Please clearly outline any additions to your order. Please Note: Standard handle only available in ARYSTO Colour. Please Note: For wetroom / grout line adjustment please contact Customer Services. **Colour is reversible.**

Select Handle

1. Standard Hinge Handle
2. Traditional Handle
3. Colour Handle

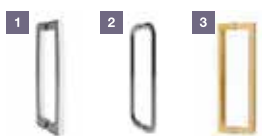

Pic 1 & 2 shows standard & traditional handles only available in a chrome finish. Pic 3 shows colour handle.

Select Door Handing - Colour is reversible

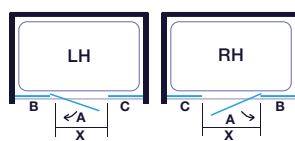

Colour Finishes; Express Yourself

When ordering your door please use the correct code to the size required. Then add the colour code you need.

Example: GHB1100H is the standard chrome code add **MB** for Matt Black, **BBS** for Brushed Stainless Steel, **BBR** for Brushed Brass, or **BBZ** for Brushed Bronze.

Example: GHB1100H + MB (Matt Black) = GHB1100H-MB.

Chrome option is your standard code.





Hinged Door and Two Inline Panels in Recess shown as Right Hand (R) - Shown in Brushed Stainless Steel

 TRUESTONE®

Match our ARYSTO 10 enclosures with our Truestone trays for that all inspiring look and feel.

Trays...



HINGE DOOR & TWO INLINE PANELS WITH SIDE PANEL

Features

- » The ultimate in frameless design with beautifully designed hinges and luxury 10mm glass - this enclosure is a true show stopper.
- » Designer hinges highly engineered to ensure smooth and solid opening and closing.
- » Minimal framework and Mershield Stayclear™ easy clean glass minimises cleaning time.
- » Inline Panel supplied with a straight/angled bracing bar.
- » Four colour options available - chrome comes as standard.
- » Bespoke options available.

HINGE DOOR & TWO INLINE PANELS WITH SIDE PANEL							CHROME PRICING		COLOUR PRICING (LONGER LEAD TIME)	
Size	Code	Adjustment Min-Max	Door Opening X	Panel A Moving Panel	Panel B Hinged Panel	Panel C Inline Panel	Price £ Exc. VAT	Price £ Inc. VAT	Price £ Exc. VAT	Price £ Inc. VAT
1100	GHD1100H (L or R)	1065-1080	570	600	251	182	2054.17	2465.00	2748.33	3298.00
1200	GHD1200H (L or R)	1165-1180	570	600	251	282	2086.67	2504.00	2792.50	3351.00
1300	GHD1300H (L or R)	1265-1280	570	600	251	382	2118.33	2542.00	2835.00	3402.00
1400	GHD1400H (L or R)	1365-1380	670	700	251	382	2189.17	2627.00	2929.17	3515.00
1500	GHD1500H (L or R)	1465-1480	670	700	351	382	2195.00	2634.00	2936.67	3524.00
1600	GHD1600H (L or R)	1565-1580	670	700	451	382	2248.33	2698.00	3008.33	3610.00
1700	GHD1700H (L or R)	1665-1680	670	700	451	482	2285.83	2743.00	3058.33	3670.00
1800	GHD1800H (L or R)	1765-1780	770	800	451	482	2326.67	2792.00	3113.33	3736.00
1900	GHD1900H (L or R)	1865-1880	770	800	451	582	2347.50	2817.00	3140.83	3769.00

Chrome is handed – please choose L for Left and R for Right when ordering. Please clearly outline any additions to your order. Please Note: For wetroom / grout line adjustment please contact Customer Service. Please Note: for colour take off 2mm for front panel adjustments. Colour is reversible.

SIDE PANEL				CHROME PRICING		COLOUR PRICING (LONGER LEAD TIME)	
Size	Code	Adjustment Min-Max	Side Panel D	Price £ Exc. VAT	Price £ Inc. VAT	Price £ Exc. VAT	Price £ Inc. VAT
700	GHSB700H	665-680	635	380.00	456.00	508.33	610.00
760	GHSB760H	725-740	723	390.83	469.00	522.50	627.00
800	GHSB800H	765-780	735	400.83	481.00	535.83	643.00
900	GHSB900H	865-880	835	423.33	508.00	566.67	680.00
1000	GHSB1000H	965-980	935	464.17	557.00	621.67	746.00

Side Panel is reversible. Please Note: Images are for illustrative purposes only. Please refer to the installation guide when fitting the product. Please Note: for colour take off 2mm for side panel adjustments.

Select Handle

1. Standard Hinge Handle
2. Traditional Handle
3. Colour Handle

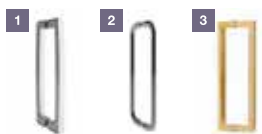

Pic 1 & 2 shows standard & traditional handles only available in a chrome finish. Pic 3 shows colour handle.

Select Door Handing - Colour is reversible

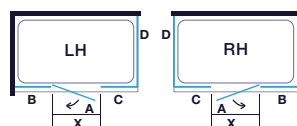

Colour Finishes; Express Yourself

When ordering your door please use the correct code to the size required. Then add the colour code you need.

Example: GHD1100H is the standard chrome code add **MB** for Matt Black, **BBS** for Brushed Stainless Steel, **BBR** for Brushed Brass, or **BBZ** for Brushed Bronze.

Example: GHD1100H + MB (Matt Black) = GHGD100H-MB. Chrome option is your standard code.



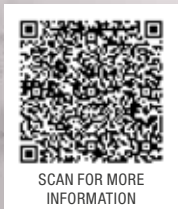

SCAN FOR MORE
INFORMATION

Hinged Door and Two Inline Panels with Side Panel shown as
Left Handed (L) - Shown in Brushed Bronze



 TRUESTONE®

Match our ARYSTO 10 enclosures
with our Truestone trays for that all
inspiring look and feel.

Trays ...



WALL HINGE DOOR IN RECESS

Features

- » The ultimate in frameless design with beautifully designed hinges and luxury 10mm glass - this enclosure is a true show stopper.
- » Designer hinges highly engineered to ensure smooth and solid opening and closing.
- » Four colour options available - chrome comes as standard.
- » Minimal framework and Mershield Stayclear™ easy clean glass minimises cleaning time.
- » Bespoke options available.

WALL HINGE DOOR IN RECESS					CHROME PRICING		COLOUR PRICING (LONGER LEAD TIME)	
Size	Code	Adjustment Min-Max	Door Opening X	Moving Panel A	Price £ Exc. VAT	Price £ Inc. VAT	Price £ Exc. VAT	Price £ Inc. VAT
650	GHE650H (L or R)	620-640	555	600	1219.17	1463.00	1630.83	1957.00
675	GHE675H (L or R)	645-665	580	625	1219.17	1463.00	1630.83	1957.00
700	GHE700H (L or R)	670-690	605	650	1219.17	1463.00	1630.83	1957.00
725	GHE725H (L or R)	695-715	630	675	1266.67	1520.00	1695.00	2034.00
750	GHE750H (L or R)	720-740	655	700	1266.67	1520.00	1695.00	2034.00
775	GHE775H (L or R)	745-765	680	725	1266.67	1520.00	1695.00	2034.00
800	GHE800H (L or R)	770-790	705	750	1266.67	1520.00	1695.00	2034.00
825	GHE825H (L or R)	795-815	730	775	1297.50	1557.00	1735.83	2083.00
850	GHE850H (L or R)	820-840	755	800	1297.50	1557.00	1735.83	2083.00
875	GHE875H (L or R)	845-865	780	825	1297.50	1557.00	1735.83	2083.00
900	GHE900H (L or R)	870-890	805	850	1297.50	1557.00	1735.83	2083.00

Please Note: All wall hinges must be secured to a reinforced/solid wall. Colour is Reversible.

Select Handle

1. Standard Hinge Handle
2. Traditional Handle
3. Colour Handle

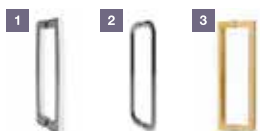

Pic 1 & 2 shows standard & traditional handles only available in a chrome finish. Pic 3 shows colour handle.

Select Door Handing - Colour is reversible

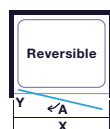

Colour Finishes; Express Yourself

When ordering your door please use the correct code to the size required. Then add the colour code you need.

Example: GHE650H is the standard chrome code add **MB** for Matt Black, **BBS** for Brushed Stainless Steel, **BBR** for Brushed Brass, or **BBZ** for Brushed Bronze.

Example: GHE650H + MB (Matt Black) = GHE650H-MB.

Chrome option is your standard code.



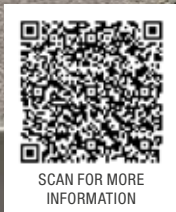

Wall Hinge Door shown as Right Handed (R) - Shown in Chrome



 TRUESTONE®

Match our ARYSTO 10 enclosures with our Truestone trays for that all inspiring look and feel.

Trays ...



WALL HINGE DOOR WITH SIDE PANEL

Features

- » The ultimate in frameless design with beautifully designed hinges and luxury 10mm glass - this enclosure is a true show stopper.
- » Designer hinges highly engineered to ensure smooth and solid opening and closing.
- » Minimal framework and Mershield Stayclear™ easy clean glass minimises cleaning time.
- » Inline Panel supplied with a straight/angled bracing bar.
- » Four colour options available - chrome comes as standard.
- » Bespoke options available.

WALL HINGE DOOR WITH SIDE PANEL					CHROME PRICING		COLOUR PRICING (LONGER LEAD TIME)	
Size	Code	Adjustment Min-Max	Door Opening X	Moving Panel A	Price £ Exc. VAT	Price £ Inc. VAT	Price £ Exc. VAT	Price £ Inc. VAT
700	GHG700H (L or R)	670-680	590	625	1285.00	1542.00	1719.17	2063.00
800	GHG800H (L or R)	770-780	690	725	1292.50	1551.00	1730.00	2076.00
900	GHG900H (L or R)	870-880	790	825	1304.17	1565.00	1745.00	2094.00

This product is handed – please choose L for Left and R for Right when ordering. Please Note: All wall hinges must be secured to a reinforced/solid wall. Please Note: All wall hinges must be secured to a reinforced/solid wall. Please Note: for colour take off 5mm for front panel adjustments. Colour is reversible.

SIDE PANEL				CHROME PRICING		COLOUR PRICING (LONGER LEAD TIME)	
Size	Code	Adjustment Min-Max	Side Panel D	Price £ Exc. VAT	Price £ Inc. VAT	Price £ Exc. VAT	Price £ Inc. VAT
700	GHSA700H	665-680	645	380.00	456.00	508.33	610.00
760	GHSA760H	725-740	705	390.83	469.00	522.50	627.00
800	GHSA800H	765-780	745	400.83	481.00	535.83	643.00
900	GHSA900H	865-880	845	423.33	508.00	566.67	680.00
1000	GHSA1000H	965-980	945	464.17	557.00	621.67	746.00

Please Note: Images are for illustrative purposes only. Please refer to the installation guide when fitting the product. Please Note: For wetroom / groud line adjustment please contact Customer Service. Please Note: for colour take off 2mm for side panel adjustments. Colour is reversible.

Select Handle

1. Standard Hinge Handle
2. Traditional Handle
3. Colour Handle

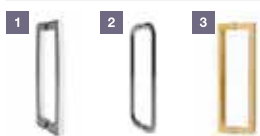

Pic 1 & 2 shows standard & traditional handles only available in a chrome finish. Pic 3 shows colour handle.

Select Door Handing - Colour is reversible

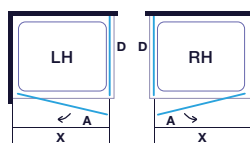

Colour Finishes; Express Yourself

When ordering your door please use the correct code to the size required. Then add the colour code you need.

Example:GHG700H is the standard chrome code add **MB** for Matt Black, **BBS** for Brushed Stainless Steel, **BBR** for Brushed Brass, or **BBZ** for Brushed Bronze.

Example: GHG700H + MB (Matt Black) = GHG700H-MB.

Chrome option is your standard code.



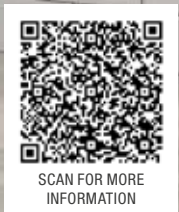

Wall Hinge Door with Side Panel shown as Left Handed (L) - Shown in Chrome



 TRUESTONE®

Match our ARYSTO 10 enclosures with our Truestone trays for that all inspiring look and feel.

Trays...



WALL HINGE DOOR & INLINE PANEL IN RECESS

Features

- » The ultimate in frameless design with beautifully designed hinges and luxury 10mm glass - this enclosure is a true show stopper.
- » Designer hinges highly engineered to ensure smooth and solid opening and closing.
- » Minimal framework and Mershield Stayclear™ easy clean glass minimises cleaning time.
- » Side Panel supplied with an angled bracing bar.
- » Four colour options available - chrome comes as standard.
- » Bespoke options available.

WALL HINGE DOOR & INLINE PANEL IN RECESS					CHROME PRICING		COLOUR PRICING (LONGER LEAD TIME)		
Size	Code	Adjustment Min-Max	Door Opening X	Panel A Moving Panel	Panel C Inline Panel	Price £ Exc. VAT	Price £ Inc. VAT	Price £ Exc. VAT	Price £ Inc. VAT
900	GHF900H (L or R)	865-890	615	650	196	1422.50	1707.00	1903.33	2284.00
925	GHF925H (L or R)	890-915	640	675	196	1496.67	1796.00	2001.67	2402.00
950	GHF950H (L or R)	915-940	665	700	196	1496.67	1796.00	2001.67	2402.00
975	GHF975H (L or R)	940-965	690	725	196	1496.67	1796.00	2001.67	2402.00
1000	GHF1000H (L or R)	965-990	715	750	196	1496.67	1796.00	2001.67	2402.00
1025	GHF1025H (L or R)	990-1015	740	775	196	1505.83	1807.00	2014.17	2417.00
1050	GHF1050H (L or R)	1015-1040	765	800	196	1505.83	1807.00	2014.17	2417.00
1075	GHF1075H (L or R)	1040-1065	790	825	196	1505.83	1807.00	2014.17	2417.00
1100	GHF1100H (L or R)	1065-1090	615	650	396	1505.83	1807.00	2014.17	2417.00
1125	GHF1125H (L or R)	1090-1115	640	675	396	1570.00	1884.00	2100.83	2521.00
1150	GHF1150H (L or R)	1115-1140	665	700	396	1570.00	1884.00	2100.83	2521.00
1175	GHF1175H (L or R)	1140-1165	690	725	396	1570.00	1884.00	2100.83	2521.00
1200	GHF1200H (L or R)	1165-1190	615	650	496	1570.00	1884.00	2100.83	2521.00
1225	GHF1225H (L or R)	1190-1215	640	675	496	1582.50	1899.00	2117.50	2541.00
1250	GHF1250H (L or R)	1215-1240	665	700	496	1582.50	1899.00	2117.50	2541.00
1275	GHF1275H (L or R)	1240-1265	690	725	496	1582.50	1899.00	2117.50	2541.00
1300	GHF1300H (L or R)	1265-1290	715	750	496	1582.50	1899.00	2117.50	2541.00
1325	GHF1325H (L or R)	1290-1315	740	775	496	1609.17	1931.00	2152.50	2583.00
1350	GHF1350H (L or R)	1315-1340	765	800	496	1609.17	1931.00	2152.50	2583.00
1375	GHF1375H (L or R)	1340-1365	790	825	496	1609.17	1931.00	2152.50	2583.00
1400	GHF1400H (L or R)	1365-1390	715	750	596	1609.17	1931.00	2152.50	2583.00
1425	GHF1425H (L or R)	1390-1415	740	775	596	1634.17	1961.00	2186.67	2624.00
1450	GHF1450H (L or R)	1415-1440	765	800	596	1634.17	1961.00	2186.67	2624.00
1475	GHF1475H (L or R)	1440-1465	790	825	596	1634.17	1961.00	2186.67	2624.00
1500	GHF1500H (L or R)	1465-1490	815	850	596	1634.17	1961.00	2186.67	2624.00

Please Note: All wall hinges must be secured to a reinforced/solid wall.

Colour is Reversible.

Select Handle

1. Standard Hinge Handle
2. Traditional Handle
3. Colour Handle

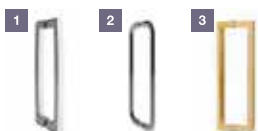

Pic 1 & 2 shows standard & traditional handles only available in a chrome finish. Pic 3 shows colour handle.

Select Door Handing - Colour is reversible

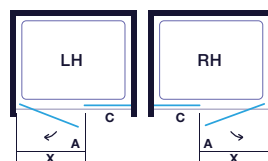

Colour Finishes; Express Yourself

When ordering your door please use the correct code to the size required. Then add the colour code you need.

Example: GHF1100H is the standard chrome code add **MB** for Matt Black, **BBS** for Brushed Stainless Steel, **BBR** for Brushed Brass, or **BBZ** for Brushed Bronze.

Example: GHF1100H + MB (Matt Black) = GHF1100H-MB.

Chrome option is your standard code.



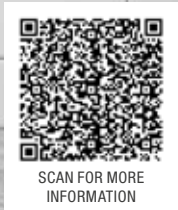

Wall Hinge Door & Inline Panel in Recess shown as Left Hand (L) - Shown in Brushed Brass



 TRUESTONE®

Match our ARYSTO 10 enclosures with our TruStone trays for that all inspiring look and feel.

Trays ...



WALL HINGED DOOR & INLINE PANEL WITH SIDE PANEL

Features

- » The ultimate in frameless design with beautifully designed hinges and luxury 10mm glass - this enclosure is a true show stopper.
- » Designer hinges highly engineered to ensure smooth and solid opening and closing.
- » Minimal framework and Mershield Stayclear™ easy clean glass minimises cleaning time.
- » Side Panel supplied with an angled bracing bar.
- » Four colour options available - chrome comes as standard.
- » Bespoke options available.

WALL HINGED DOOR & INLINE PANEL WITH SIDE PANEL						CHROME PRICING		COLOUR PRICING (LONGER LEAD TIME)	
Size	Code	Adjustment Min-Max	Door Opening X	Panel A Moving Panel	Panel C Inline Panel	Price £ Exc. VAT	Price £ Inc. VAT	Price £ Exc. VAT	Price £ Inc. VAT
900	GHH900H (L or R)	865-875	615	650	182	1562.50	1875.00	2090.00	2508.00
1000	GHH1000H (L or R)	965-975	615	650	282	1574.17	1889.00	2105.83	2527.00
1100	GHH1100H (L or R)	1065-1075	615	650	382	1584.17	1901.00	2119.17	2543.00
1200	GHH1200H (L or R)	1165-1175	615	650	482	1631.67	1958.00	2183.33	2620.00
1300	GHH1300H (L or R)	1265-1275	715	750	482	1645.83	1975.00	2201.67	2642.00
1400	GHH1400H (L or R)	1365-1375	715	750	582	1674.17	2009.00	2239.17	2687.00
1500	GHH1500H (L or R)	1465-1475	815	850	582	1761.67	2114.00	2356.67	2828.00

Chrome is handed – please choose L for Left and R for Right when ordering. Colour is reversible.

Please clearly outline any additions to your order.

Please Note: All wall hinges must be secured to a reinforced/solid wall.

Please Note: For wetroom / grout line adjustment please contact Customer Service.

Please Note: Images are for illustrative purposes only. Please refer to the installation guide when fitting the product.

Please Note: for colour take off 2mm for front panel adjustments.

SIDE PANEL				CHROME PRICING		COLOUR PRICING (LONGER LEAD TIME)	
Size	Code	Adjustment Min-Max	Panel Size D	Price £ Exc. VAT	Price £ Inc. VAT	Price £ Exc. VAT	Price £ Inc. VAT
700	GHSB700H	665-680	635	380.00	456.00	508.33	610.00
760	GHSB760H	725-740	695	390.83	469.00	522.50	627.00
800	GHSB800H	765-780	735	400.83	481.00	535.83	643.00
900	GHSB900H	865-880	835	423.33	508.00	566.67	680.00
1000	GHSB1000H	965-980	935	464.17	557.00	621.67	746.00

Side Panel is reversible. Please Note: for colour take off 2mm for side panel adjustments.

Select Handle

- Standard Hinge Handle
- Traditional Handle
- Colour Handle

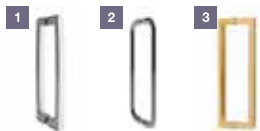

Pic 1 & 2 shows standard & traditional handles only available in a chrome finish. Pic 3 shows colour handle.

Select Door Handing - Colour is reversible

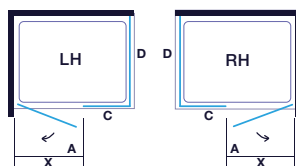

Colour Finishes; Express Yourself

When ordering your door please use the correct code to the size required. Then add the colour code you need.

Example: GHH1100H is the standard chrome code add **MB** for Matt Black, **BBS** for Brushed Stainless Steel, **BBR** for Brushed Brass, or **BBZ** for Brushed Bronze.

Example: GHH1100H + MB (Matt Black) = GHH1100H-MB.

Chrome option is your standard code.



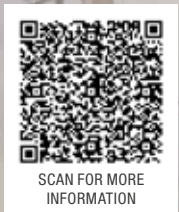

Wall Hinge Door & Inline Panel with Side Panel shown as Left Hand (L) - Shown in Chrome



TRUESTONE®

Match our ARYSTO 10 enclosures with our Truestone trays for that all inspiring look and feel.

Trays...



PENTANGLE

Features

- » The ultimate in frameless design with beautifully designed hinges and luxury 10mm glass - this enclosure is a true show stopper.
- » Designer hinges highly engineered to ensure smooth and solid opening and closing.
- » Minimal framework and Mershield Stayclear™ easy clean glass minimises cleaning time.
- » Supplied with a straight bracing bar to be positioned over the door.
- » Bespoke options available.

PENTANGLE								
Size	Code	Adjustment Min-Max	Door Opening X	Moving Panel A	Panel B Inline Panel	Panel C Hinged Panel	Price £ Exc. VAT	Price £ Inc. VAT
900 x 900	GHI9090H (L or R)	870-885 / 870-885	620	672	405	405	2183.33	2620.00
1200 x 900	GHI1290H (L or R)	1170-1185 / 870-885	620	672	705	405	2320.00	2784.00
1400 x 900	GHI1490H (L or R)	1370-1385 / 870-885	620	672	905	405	2369.17	2843.00

This product is handed – please choose L for Left and R for Right when ordering. Please Note: Images are for illustrative purposes only. Please refer to the installation guide when fitting the product. Please Note: for wetroom / grout line adjustment please contact customer service.



Pentangle Tray

Pentangle Tray Features

- » Height 40mm.
- » Handcrafted from high grade stone resin.
- » Integrated discreet waste.
- » Luxurious matte textured finish.
- » Comes with 90mm fast flow waste.

PENTANGLE TRAY			
Size	Code	Price £ Exc. VAT	Price £ Inc. VAT
900 x 900	T90PW	453.33	544.00
1200 x 900 (R)	T129PWR	505.83	607.00
1200 x 900 (L)	T129PWL	505.83	607.00
1400 x 900 (R)	T149PWR	535.83	643.00
1400 x 900 (L)	T149PWL	535.83	643.00

This product is handed – please choose L for Left and R for Right when ordering.

Select Handle

1. Standard Hinge Handle
2. Traditional Handle

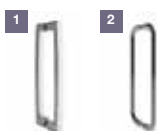

Select Door Handling (Pentangle)

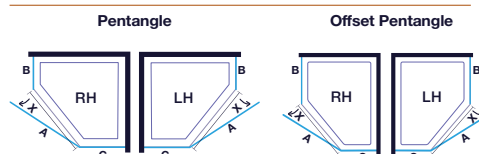

Select Door Handling (Pentangle Tray)



Please Note: Images are for illustrative purposes only. Please refer to the installation guide when fitting the product.

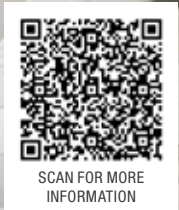

Pentangle Door shown as Left Hand (L) - Shown in Chrome



Match our ARYSTO 10 enclosures with our trays for that all inspiring look and feel. Our pentangle tray only comes in white with a natural stone resin finish.

Trays...

FREE

MERLYN Wiper with each complete purchase of an ARYSTO Ten Product! (chrome enclosures only).



THE WETROOM COLLECTION

Whether you are after a New York style loft or you need to create a bathroom with inclusive design, then Wetrooms are the solution for you. Suitable for both corner installation, with or without end panels, or in an alcove / recess.





Shower Panel - Shown in Brushed Brass



WETROOM PANEL WITH OR WITHOUT END PANEL

Features

- » The definition of modern showering - the simple shower panel stands at 2000mm high and 2015mm high with rail and provides an easy walk-through, making you feel instantly refreshed.
- » Frameless glass and Mershield Stayclear™ easy clean glass minimises cleaning time.

- » All panels 1100mm and over come with a 1000mm straight stabilising bar.
- » Four colour options available - chrome comes as standard.
- » Bespoke options available.

WETROOM PANEL			CHROME PRICING		COLOUR PRICING (LONGER LEAD TIME)	
Size	Code	Adjustment Min-Max	Price £ Exc. VAT	Price £ Inc. VAT	Price £ Exc. VAT	Price £ Inc. VAT
400	GWA400H	375-390	640.83	769.00	856.67	1028.00
600	GWA600H	575-590	666.67	800.00	891.67	1070.00
700	GWA700H	675-690	680.00	816.00	909.17	1091.00
800	GWA800H	775-790	680.00	816.00	909.17	1091.00
900	GWA900H	875-890	712.50	855.00	952.50	1143.00
1000	GWA1000H	975-990	740.83	889.00	990.83	1189.00
1100	GWA1100H	1075-1090	797.50	957.00	1066.67	1280.00
1200	GWA1200H	1175-1190	836.67	1004.00	1119.17	1343.00
1300	GWA1300H	1275-1290	869.17	1043.00	1162.50	1395.00
1400	GWA1400H	1375-1390	908.33	1090.00	1215.00	1458.00
1500	GWA1500H	1475-1490	934.17	1121.00	1250.00	1500.00
1600	GWA1600H	1575-1590	960.83	1153.00	1285.00	1542.00

Please Note: All panels 1100mm and over are supplied with a 1M straight bracing bar.

END PANEL			CHROME PRICING		COLOUR PRICING (LONGER LEAD TIME)	
Size	Code	Adjustment Min-Max	Price £ Exc. VAT	Price £ Inc. VAT	Price £ Exc. VAT	Price £ Inc. VAT
400	GWA400H	375-390	640.83	769.00	856.67	1028.00
600	GWA600H	575-590	666.67	800.00	891.67	1070.00
700	GWA700H	675-690	680.00	816.00	909.17	1091.00
800	GWA800H	775-790	680.00	816.00	909.17	1091.00
900	GWA900H	875-890	712.50	855.00	952.50	1143.00
1000	GWA1000H	975-990	740.83	889.00	990.83	1189.00

Note: Minimum opening we recommend is 500mm.

Technical drawing

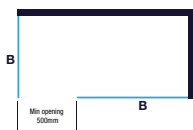

Please Note: Images are for illustrative purposes only. Please refer to the installation guide when fitting the product. All products priced based on mirrored chrome finish. Please clearly outline any additions to your order.

Colour Finishes; Express Yourself

When ordering your door please use the correct code to the size required. Then add the colour code you need.

Example: GWA1100H is the standard chrome code add **MB** for Matt Black, **BBS** for Brushed Stainless Steel, **BBR** for Brushed Brass, or **BBZ** for Brushed Bronze.

Example: GWA1100H + MB (Matt Black) = GWA1100HMB.

Chrome option is your standard code.



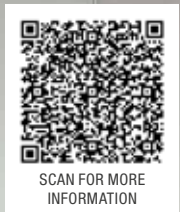

SCAN FOR MORE
INFORMATION

Shower Panel shown with End Panel



 TRUESTONE®

Match our ARYSTO 10 enclosures with our Truestone trays for that all inspiring look and feel.

Trays ...



WETROOM PANEL & HINGED PANEL WITH OR WITHOUT END PANEL

Features

- » The Wetroom Panel and Hinge panel is designed to gently reflect water into your showering area and give added protection against splashes.
- » Frameless glass and Mershield Stayclear™ easy clean glass minimises cleaning time.
- » Only our 1100mm wetroom panels or over are supplied with 1M bracing bar as standard.
- » Two colour options available in the wetroom panel & hinge panel enclosure - chrome comes as standard.
- » Bespoke options available.

WETROOM PANEL & HINGE PANEL COMES IN MATT BLACK & BRUSHED BRASS ONLY					CHROME PRICING		COLOUR PRICING (LONGER LEAD TIME)	
Size	Code	Adjustment Min-Max	Shower Panel	Hinge Panel	Price £ Exc. VAT	Price £ Inc. VAT	Price £ Exc. VAT	Price £ Inc. VAT
1000	GWE1000H	675-690	673	300	1267.50	1521.00	1556.67	1868.00
1100	GWE1100H	775-790	773	300	1294.17	1553.00	1588.33	1906.00
1200	GWE1200H	875-890	873	300	1300.00	1560.00	1596.67	1916.00
1300	GWE1300H	975-990	973	300	1430.00	1716.00	1755.83	2107.00
1500	GWE1500H	1175-1190	1173	300	1690.83	2029.00	2075.83	2491.00

Please Note: All wetroom panels with hinge panels are supplied with 1M bracing bar as standard.. Please Note: Product is 2015mm high including stabilising bar. Please Note: for colour adjustment add 5mm extra to chrome adjustment.

END PANEL			CHROME PRICING		COLOUR PRICING (LONGER LEAD TIME)	
Size	Code	Adjustment Min-Max	Price £ Exc. VAT	Price £ Inc. VAT	Price £ Exc. VAT	Price £ Inc. VAT
400	GWA400H	375-390	640.83	769.00	856.67	1028.00
600	GWA600H	575-590	666.67	800.00	891.67	1070.00
700	GWA700H	675-690	680.00	816.00	909.17	1091.00
800	GWA800H	775-790	680.00	816.00	909.17	1091.00
900	GWA900H	875-890	712.50	855.00	952.50	1143.00
1000	GWA1000H	975-990	740.83	889.00	990.83	1189.00

Note: Minimum opening we recommend is 500mm.

Technical drawing

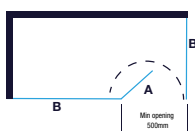

Please Note: Images are for illustrative purposes only. Please refer to the installation guide when fitting the product. All products priced based on mirrored chrome finish. Please clearly outline any additions to your order.

Colour Finishes; Express Yourself

When ordering your door please use the correct code to the size required. Then add the colour code you need.

Example: GWE1100H is the standard chrome code add **MB** for Matt Black, **BBR** for Brushed Brass

Example: GWE1100H + MB (Matt Black) = GWE1100H-MB.

Chrome option is your standard code.





Shower Panel shown with End Panel shown in Brushed Brass



SCAN FOR MORE INFORMATION

 TRUESTONE®

Match our ARYSTO 10 enclosures with our Truestone trays for that all inspiring look and feel.

Trays ...



WETROOM PANEL WITH DOUBLE ENTRY

Features

- » The definition of modern showering - the simple shower panel stands at 2000mm high and 2015mm high with rail and provides an easy walk-through, making you feel instantly refreshed.
- » Frameless glass and Mershield Stayclear™ easy clean glass minimises cleaning time.
- » Supplied with two straight 1000mm bracing bars.
- » Four colour options available - chrome comes as standard.
- » Bespoke options available.

WETROOM PANEL WITH DOUBLE ENTRY			CHROME PRICING		COLOUR PRICING (LONGER LEAD TIME)	
Size	Code	Glass Width	Price £ Exc. VAT	Price £ Inc. VAT	Price £ Exc. VAT	Price £ Inc. VAT
1400	GWF1400H	1380	1012.50	1215.00	1355.00	1626.00
1600	GWF1600H	1580	1039.17	1247.00	1471.67	1766.00

Supplied with two straight 1000mm bracing bars. Please Note: Images are for illustrative purposes only. Please refer to the installation guide when fitting the product. Please Note: for colour version total width is 1386mm and 1586mm due to provided end caps.

Technical drawing



Please Note: Images are for illustrative purposes only. Please refer to the installation guide when fitting the product. All products priced based on mirrored chrome finish. Please clearly outline any additions to your order.

Colour Finishes; Express Yourself

When ordering your door please use the correct code to the size required. Then add the colour code you need.

Example: GWA1100H is the standard chrome code add **MB** for Matt Black, **BBR** for Brushed Brass, **BBZ** for Brushed Bronze or **BSS** for Brushed Stainless Steel

Example: GWF100H + MB (Matt Black) = GWF100H-MB.

Chrome option is your standard code.



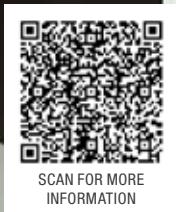

Double Entry Shower Panel



 TRUESTONE®

Match our ARYSTO 10 enclosures with our Truestone trays for that all inspiring look and feel.

Trays ...

THE BESPOKE COLLECTION

The Arysto Bespoke Collection has everything you need to create that unique showering experience. Whether your preference is for an ultra modern wetroom or something more unique for your attic conversion. The Bespoke Collection allows you to tailor any of our already stunning enclosures / wetroom panels to create a truly unique enclosure for your bathroom. Choose from an array of options such as 5 glazing finishes, UV Bonding, increased heights and widths and the ability to cut to almost any shape or size to fit any awkward spaces, creating that perfect showering experience in your home. Factor in the reliable survey and installation services as well as the Lifetime Guarantee and you've got added peace of mind.



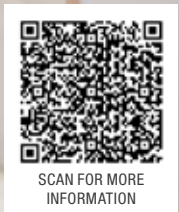

Arysto Bespoke Steam Room in Brushed Bronze

The Arysto Bespoke Collection has everything you need to create that unique showering experience. Whether your preference is for an ultra-modern wetroom or something more unique for your attic conversion.

Choose from an array of options such as 4 glazing finishes, UV bonding, increased heights and widths and the ability to cut to almost any shape or size to fit any awkward spaces, creating that perfect showering experience in your home. Factor in the reliable survey and installation services as well as the lifetime guarantee and you've got added peace of mind. Any sizes outside of those mentioned please contact: bespoke@merlyn.ie or phone: 0808 1011 429

FIVE GLAZING FINISHES

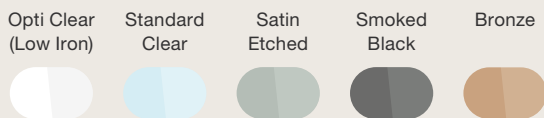

FIVE COLOUR OPTIONS

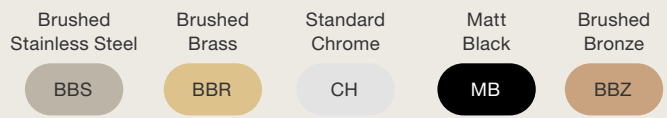

SEVEN HANDLE TYPES



THREE PANEL SLIDING DOOR

Shown with increased height.



WALL HINGE DOOR WITH INLINE PANEL

Shown with dwarf wall and notch cut.



SCAN FOR MORE INFORMATION

Please Note

Before we are able to survey your site, your shower tray must be fully installed and all wall tiles finished. It is essential due to the weight of the glass that there is sufficient grounds for fixing all hinges and bracket to all walls and ceilings where appropriate. Cost of the installation and delivery may increase due to: weight of the glass panels, increase size of the glass panels or restricted access to site.

WALK IN

Shown with increased height, notch and angle cut and 2 towel rails.



HINGE DOOR

Shown with increased height and smoked black glass



Here is a brief guide to the services and options available through our Bespoke Collection. We can tailor any enclosure from our ARYSTO Collection to suit your unique requirements.

NOTCH CUT, ANGLE CUT AND DWARF WALLS

With these options you can fit your shower enclosure to any space.

Angle Cut



Dwarf Walls



Notch Cut



UV BONDING

UV technology gives you an optically clear, strong perfect bond. UV Bonding (Two pieces of glass bonded together).



STABILISING BAR

Angled Stabilising Bar



Straight Stabilising Bar



T-Bar



Ceiling Brackets



WALL & FLOOR

Standard Floor Profile



Recessed Floor Profile - only available in chrome



Standard Wall Profile



Recessed Wall Profile



ACCESSORIES

Only available in chrome

Seat



Standard towel rail



Traditional towel rail



Shelf



Please Note

ARYSTO offer a Survey and Installation Service as we understand that creating your dream showering enclosure can be difficult, especially if dealing with awkward spaces. We have a team of highly skilled and experienced professionals who are trained to survey for varying slopes and angles, look for 'out of true' walls and assess that your choice of enclosure is suitable. Prices available upon request.



How to order your bespoke product

Step 1: Customize Your Space

- » Contact bespoke for confirmed prices. Email: bespoke@merlyn.ie or phone: 0808 1011 429.
- » Configure your space below.
- » Note: prices provided are indicative.

Step 2: Schedule MERLYN Engineer

- » Ensure tray and wall tiles are finished before scheduling.
- » Coordinate with merlyn engineer for installation.
- » Note: timing is crucial, coordinate accordingly. Email: bespoke@merlyn.ie or phone: 0808 1011 429

Step 3: Sign Off Drawing

- » Review the final drawing of your space.
- » Confirm all details are customised
- » Sign off on the drawing.
- » Allow 4-6 weeks for processing & installation.

GM100BESPOKE - HINGE AND 1 INLINE IN RECESS (GHA)

All prices below include unlimited notch/cuts

DIMENSIONS	CHROME Exc. VAT	COLOUR Exc. VAT	MEASURE Exc. VAT	INSTALLATION Exc. VAT
Up to 1000mm W & 2400mm H	2250	2600	250	650
Up to 1300mm W & 2400mm H	2500	2900	250	650
Up to 1600mm W & 2400mm H	2750	3200	250	650
Up to 2000mm W & 2400mm H	3000	3500	250	650

ADDITIONAL HEIGHT OPTIONS

Height Above 2400mm	POA	POA	POA	POA
---------------------	-----	-----	-----	-----

ADDITIONAL GLASS OPTIONS

Opti Clear, Bronze, Smoked Black & Satin Etched	250	250	N/A	N/A
---	-----	-----	-----	-----

Where an installation is a 2 man installation, there will be an additional £200 Exc VAT added and can be removed if a qualified personnel is on site to assist. All wall hinges must be secured to a reinforced wall. For large panel installations three hinges may be required.

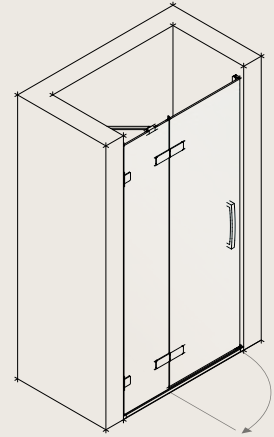

GM200BESPOKE - HINGE AND 2 INLINE RECESS (GHB)

All prices below include unlimited notch/cuts

DIMENSIONS	CHROME Exc. VAT	COLOUR Exc. VAT	MEASURE Exc. VAT	INSTALLATION Exc. VAT
Up to 1200mm W & 2400mm H	3000	3500	250	700
Up to 1500mm W & 2400mm H	3250	3750	250	700
Up to 1700mm W & 2400mm H	3500	4000	250	700
Up to 2000mm W & 2400mm H	3750	4250	250	700
Up to 2400mm W & 2400mm H	4000	4500	250	700

ADDITIONAL HEIGHT OPTIONS

Height Above 2400mm	POA	POA	POA	POA
---------------------	-----	-----	-----	-----

ADDITIONAL GLASS OPTIONS

Opti Clear, Bronze, Smoked Black & Satin Etched	300	300	N/A	N/A
---	-----	-----	-----	-----

Where an installation is a 2 man installation, there will be an additional £200 Exc VAT added and can be removed if a qualified personnel is on site to assist. All wall hinges must be secured to a reinforced wall. For large panel installations three hinges may be required.

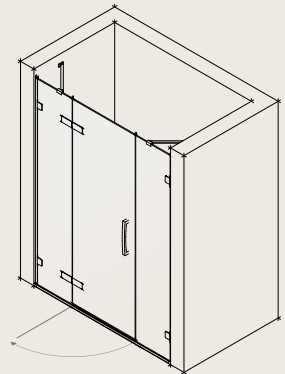

GM300BESPOKE - HINGE AND 1 INLINE WITH SIDE PANEL (GHG)

All prices below include unlimited notch/cuts

DIMENSIONS	CHROME Exc. VAT	COLOUR Exc. VAT	MEASURE Exc. VAT	INSTALLATION Exc. VAT
Up to 1000mm W & 2400mm H	2250	2600	250	700
Up to 1300mm W & 2400mm H	2500	2900	250	700
Up to 1600mm W & 2400mm H	2750	3200	250	700
Up to 2000mm W & 2400mm H	3000	3500	250	700

ADDITIONAL HEIGHT OPTIONS

Height Above 2400mm	POA	POA	POA	POA
---------------------	-----	-----	-----	-----

SIDE PANEL OPTIONS

Up to 900mm W & 2400mm H	900	1100	N/A	N/A
Up to 1200mm W & 2400mm H	1100	1300	N/A	N/A
Up to 1600mm W & 2400mm H	1300	1500	N/A	N/A

ADDITIONAL GLASS OPTIONS

Opti Clear, Bronze, Smoked Black & Satin Etched	300	300	N/A	N/A
---	-----	-----	-----	-----

Where an installation is a 2 man installation, there will be an additional £200 Exc VAT added and can be removed if a qualified personnel is on site to assist. All wall hinges must be secured to a reinforced wall. For large panel installations three hinges may be required.

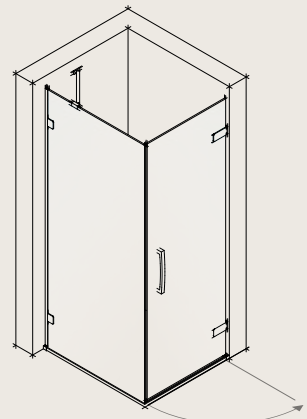

GM400BESPOKE - HINGE AND 2 INLINE WITH SIDE PANEL (GHD)

All prices below include unlimited notch/cuts

DIMENSIONS	CHROME Exc. VAT	COLOUR Exc. VAT	MEASURE Exc. VAT	INSTALLATION Exc. VAT
Up to 1200mm W & 2400mm H	3000	3500	250	750
Up to 1500mm W & 2400mm H	3250	3750	250	750
Up to 1700mm W & 2400mm H	3500	4000	250	750
Up to 2000mm W & 2400mm H	3750	4250	250	750
Up to 2400mm W & 2400mm H	4000	4500	250	750
ADDITIONAL HEIGHT OPTIONS				
Height Above 2400mm	POA	POA	POA	POA
SIDE PANEL OPTIONS				
Up to 900mm W & 2400mm H	900	1100	N/A	N/A
Up to 1200mm W & 2400mm H	1100	1300	N/A	N/A
Up to 1600mm W & 2400mm H	1300	1500	N/A	N/A
ADDITIONAL GLASS OPTIONS				
UV Bonding	200	200	N/A	N/A
Opti Clear, Bronze, Smoked Black & Satin Etched	350	350	N/A	N/A

Where an installation is a 2 man installation, there will be an additional £200 Exc VAT added and can be removed if a qualified personnel is on site to assist. All wall hinges must be secured to a reinforced wall. For large panel installations three hinges may be required.

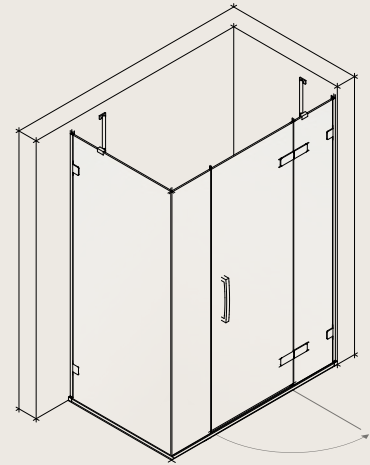

GM500BESPOKE - WALL HINGE IN RECESS (GHE)

All prices below include unlimited notch/cuts

DIMENSIONS	CHROME Exc. VAT	COLOUR Exc. VAT	MEASURE Exc. VAT	INSTALLATION Exc. VAT
Up to 900mm W & 2400mm H	1750	2000	250	600
ADDITIONAL HEIGHT OPTIONS				
Height Above 2400mm	POA	POA	POA	POA
ADDITIONAL GLASS OPTIONS				
Opti Clear, Bronze, Smoked Black & Satin Etched	200	200	N/A	N/A

Where an installation is a 2 man installation, there will be an additional £200 Exc VAT added and can be removed if a qualified personnel is on site to assist. All wall hinges must be secured to a reinforced wall. For large panel installations three hinges may be required.

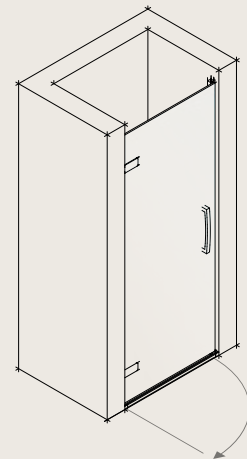

GM600BESPOKE - WALL HINGE AND 1 INLINE IN RECESS (GHF)

All prices below include unlimited notch/cuts

DIMENSIONS	CHROME Exc. VAT	COLOUR Exc. VAT	MEASURE Exc. VAT	INSTALLATION Exc. VAT
Up to 1000mm W & 2400mm H	2250	2600	250	650
Up to 1300mm W & 2400mm H	2500	2900	250	650
Up to 1600mm W & 2400mm H	2750	3200	250	650
Up to 2000mm W & 2400mm H	3000	3500	250	650
ADDITIONAL HEIGHT OPTIONS				
Height Above 2400mm	POA	POA	POA	POA
ADDITIONAL GLASS OPTIONS				
Opti Clear, Bronze, Smoked Black & Satin Etched	250	250	N/A	N/A

Where an installation is a 2 man installation, there will be an additional £200 Exc VAT added and can be removed if a qualified personnel is on site to assist. All wall hinges must be secured to a reinforced wall. For large panel installations three hinges may be required.

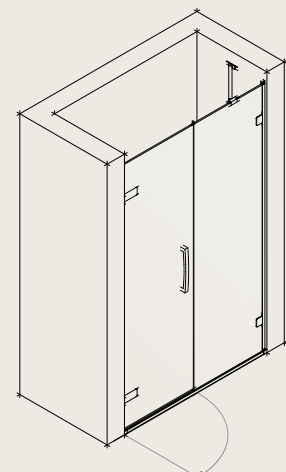

GM700BESPOKE - WALL HINGE WITH SIDE PANEL (GHG)

All prices below include unlimited notch/cuts

DIMENSIONS	CHROME Exc. VAT	COLOUR Exc. VAT	MEASURE Exc. VAT	INSTALLATION Exc. VAT
Up to 900mm W & 2400mm H	1750	2000	250	650
ADDITIONAL HEIGHT OPTIONS				
Height Above 2400mm	POA	POA	POA	POA
SIDE PANEL OPTIONS				
Up to 900mm W & 2400mm H	900	1100	N/A	N/A
Up to 1200mm W & 2400mm H	1100	1300	N/A	N/A
Up to 1600mm W & 2400mm H	1300	1500	N/A	N/A
ADDITIONAL GLASS OPTIONS				
Opti Clear, Bronze, Smoked Black & Satin Etched	250	250	N/A	N/A

Where an installation is a 2 man installation, there will be an additional £200 Exc VAT added and can be removed if a qualified personnel is on site to assist. All wall hinges must be secured to a reinforced wall. For large panel installations three hinges may be required.

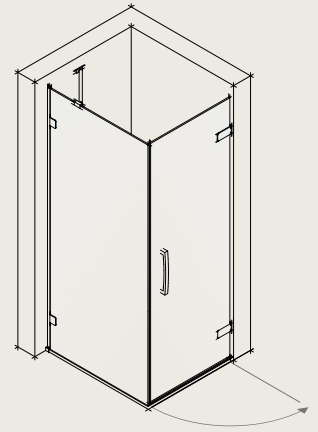

GM800BESPOKE - WALL HINGE DOOR AND 1 INLINE WITH SIDE PANEL (GHH)

All prices below include unlimited notch/cuts

DIMENSIONS	CHROME Exc. VAT	COLOUR Exc. VAT	MEASURE Exc. VAT	INSTALLATION Exc. VAT
Up to 1000mm W & 2400mm H	2250	2600	250	700
Up to 1300mm W & 2400mm H	2500	2900	250	700
Up to 1600mm W & 2400mm H	2750	3200	250	700
Up to 2000mm W & 2400mm H	3000	3500	250	700
ADDITIONAL HEIGHT OPTIONS				
Height Above 2400mm	POA	POA	POA	POA
SIDE PANEL OPTIONS				
Up to 900mm W & 2400mm H	900	1100	N/A	N/A
Up to 1200mm W & 2400mm H	1100	1300	N/A	N/A
Up to 1600mm W & 2400mm H	1300	1500	N/A	N/A
ADDITIONAL GLASS OPTIONS				
Opti Clear, Bronze, Smoked Black & Satin Etched	300	300	N/A	N/A
UV Bonding	200	200	N/A	N/A

Where an installation is a 2 man installation, there will be an additional £200 Exc VAT added and can be removed if a qualified personnel is on site to assist. All wall hinges must be secured to a reinforced wall. For large panel installations three hinges may be required.

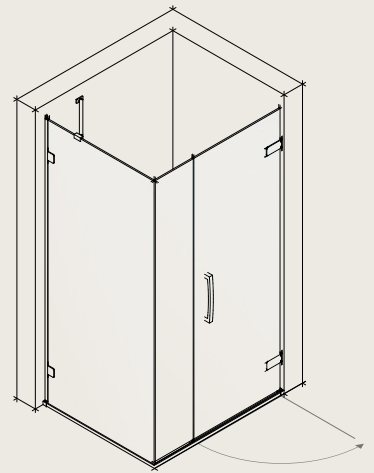

GMPENTBESPOKE - PENTANGLE (GHI)

All prices below include unlimited notch/cuts

DIMENSIONS	CHROME Exc. VAT	COLOUR Exc. VAT	MEASURE Exc. VAT	INSTALLATION Exc. VAT
Up to 900mm W & 2400mm H	3300	N/A	250	700
Up to 1200mm W & 2400mm H	3600	N/A	250	700
Up to 1400mm W & 2400mm H	3900	N/A	250	700
ADDITIONAL HEIGHT OPTIONS				
Height Above 2400mm	POA	POA	POA	POA
ADDITIONAL GLASS OPTIONS				
Opti Clear, Bronze, Smoked Black & Satin Etched	300	300	N/A	N/A

Where an installation is a 2 man installation, there will be an additional £200 Exc VAT added and can be removed if a qualified personnel is on site to assist. All wall hinges must be secured to a reinforced wall. For large panel installations three hinges may be required.

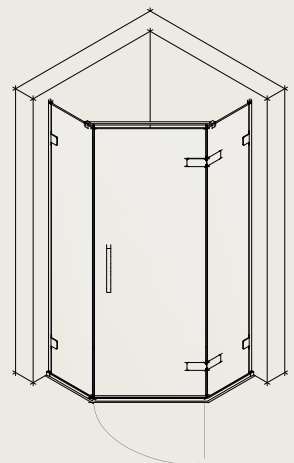

GMBS1BESPOKE - 1 PANEL BATHSCREEN

All prices below include unlimited notch/cuts

DIMENSIONS	CHROME Exc. VAT	COLOUR Exc. VAT	MEASURE Exc. VAT	INSTALLATION Exc. VAT
Up to 1000mm W & 1500mm H	1200	1400	250	550
Up to 1100mm W & 1500mm H	1200	1400	250	550
ADDITIONAL HEIGHT OPTIONS				
Height Above 1500mm	POA	POA	POA	POA
ADDITIONAL GLASS OPTIONS				
Opti Clear, Bronze, Smoked Black & Satin Etched	200	200	N/A	N/A

Where an installation is a 2 man installation an addition £200 Exc. VAT would be added. For any bathscreen size over 875mm by 2 metres high you will need three hinges.

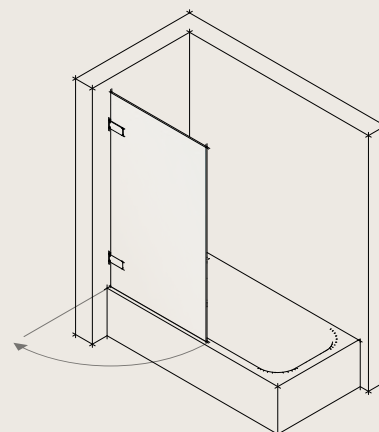

GMBS2BESPOKE - 2 PANEL BATHSCREEN

All prices below include unlimited notch/cuts

DIMENSIONS	CHROME Exc. VAT	COLOUR Exc. VAT	MEASURE Exc. VAT	INSTALLATION Exc. VAT
Up to 1000mm W & 1500mm H	1400	1600	250	550
Up to 1300mm W & 1500mm H	1400	1600	250	550
Up to 1600mm W & 1500mm H	1400	1600	250	550
ADDITIONAL HEIGHT OPTIONS				
Height Above 1500mm	POA	POA	POA	POA
ADDITIONAL GLASS OPTIONS				
Opti Clear, Bronze, Smoked Black & Satin Etched	250	250	N/A	N/A

Where an installation is a 2 man installation an addition £200 Exc. VAT would be added. For any bathscreen size over 875mm by 2 metres high you will need three hinges.

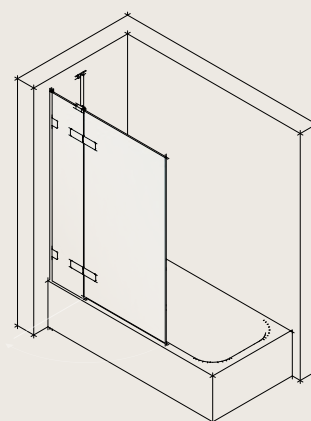

GMW700BESPOKE - DOUBLE ENTRY (GWF)

All prices below include unlimited notch/cuts

DIMENSIONS	CHROME Exc. VAT	COLOUR Exc. VAT	MEASURE Exc. VAT	INSTALLATION Exc. VAT
Up to 1400mm W & 2100mm H	1200	1400	250	600
Up to 1600mm W & 2100mm H	1300	1500	250	600
ADDITIONAL HEIGHT OPTIONS				
Height Above 2100mm	POA	POA	POA	POA
ADDITIONAL GLASS OPTIONS				
Opti Clear, Bronze, Smoked Black & Satin Etched	200	200	N/A	N/A

Where an installation is a 2 man installation, there will be an additional £200 Exc VAT added and can be removed if a qualified personnel is on site to assist. All wall hinges must be secured to a reinforced wall. For large panel installations three hinges may be required.

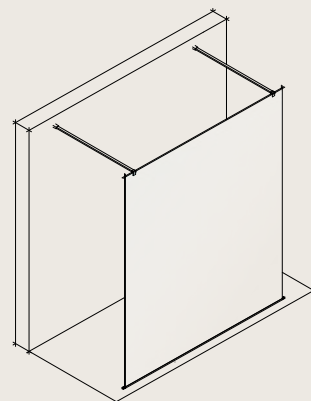

GMW800BESPOKE - DOUBLE ENTRY AND RETURN (GWG)

All prices below include unlimited notch/cuts

DIMENSIONS	CHROME Exc. VAT	COLOUR Exc. VAT	MEASURE Exc. VAT	INSTALLATION Exc. VAT
Up to 1400mm/500 & 2100mm H	2000	2500	250	650
Up to 2000mm/500 & 2100mm H	2500	3000	250	650
ADDITIONAL HEIGHT OPTIONS				
Height Above 2100mm	POA	POA	POA	POA
ADDITIONAL GLASS OPTIONS				
Opti Clear, Bronze, Smoked Black & Satin Etched	250	250	N/A	N/A
UV Bonding	200	200	N/A	N/A

Where an installation is a 2 man installation, there will be an additional £200 Exc VAT added and can be removed if a qualified personnel is on site to assist. All wall hinges must be secured to a reinforced wall. For large panel installations three hinges may be required.

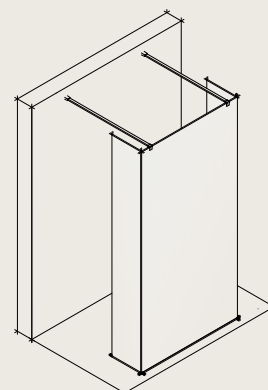

GMW100BESPOKE - SINGLE WETROOM PANEL (GWA)

All prices below include unlimited notch/cuts

DIMENSIONS	CHROME Exc. VAT	COLOUR Exc. VAT	MEASURE Exc. VAT	INSTALLATION Exc. VAT
Up to 600mm W & 2400mm H	800	1000	250	600
Up to 800mm W & 2400mm H	900	1100	250	600
Up to 1000mm W & 2400mm H	1000	1200	250	600
Up to 1200mm W & 2400mm H	1100	1300	250	600
Up to 1400mm W & 2400mm H	1200	1400	250	600
Up to 1600mm W & 2400mm H	1300	1500	250	600
Up to 1800mm W & 2400mm H	1400	1600	250	600
Up to 2000mm W & 2400mm H	1500	1700	250	600

ADDITIONAL HEIGHT OPTIONS

Height Above 2400mm	POA	POA	POA	POA
---------------------	-----	-----	-----	-----

ADDITIONAL GLASS OPTIONS

Opti Clear, Bronze, Smoked Black & Satin Etched	200	200	N/A	N/A
---	-----	-----	-----	-----

Where an installation is a 2 man installation, there will be an additional £200 Exc VAT added and can be removed if a qualified personnel is on site to assist. All wall hinges must be secured to a reinforced wall. For large panel installations three hinges may be required.

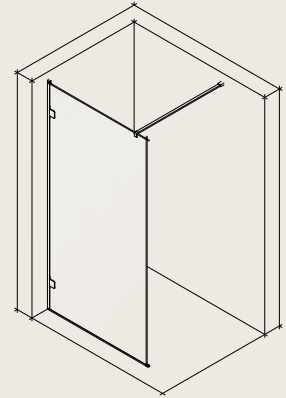

GMW300BESPOKE - CUBE WETROOM AND END PANEL

All prices below include unlimited notch/cuts

DIMENSIONS	CHROME Exc. VAT	COLOUR Exc. VAT	MEASURE Exc. VAT	INSTALLATION Exc. VAT
Up to 1000mm W + 400mm & 2400mm H	1400	1800	250	700
Up to 1300mm W + 400mm & 2400mm H	1600	2000	250	700
Up to 1600mm W + 400mm & 2400mm H	1800	2200	250	700
Up to 2000mm W + 400mm & 2400mm H	2000	2400	250	700

ADDITIONAL END PANEL OPTIONS

Up to 1000mm W & 2400mm H	1000	1200	N/A	N/A
Up to 1400mm W & 2400mm H	1200	1400	N/A	N/A
Up to 1600mm W & 2400mm H	1300	1500	N/A	N/A

ADDITIONAL HEIGHT OPTIONS

Height Above 2400mm	POA	POA	POA	POA
---------------------	-----	-----	-----	-----

ADDITIONAL GLASS OPTIONS

Opti Clear, Bronze, Smoked Black & Satin Etched	250	250	N/A	N/A
UV Bonding	200	200	N/A	N/A

Where an installation is a 2 man installation, there will be an additional £200 Exc VAT added and can be removed if a qualified personnel is on site to assist. All wall hinges must be secured to a reinforced wall. For large panel installations three hinges may be required.

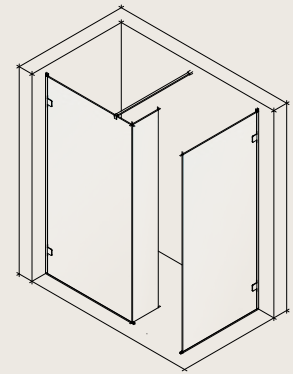

GMW500BESPOKE - WETROOM PANEL WITH SWIVEL AND END PANEL (GWE)

All prices below include unlimited notch/cuts

DIMENSIONS	CHROME Exc. VAT	COLOUR Exc. VAT	MEASURE Exc. VAT	INSTALLATION Exc. VAT
Up to 600 mm + 400mm & 2400mm H	1750	2000	250	650
Up to 1000mm + 400mm & 2400mm H	2000	2250	250	650
Up to 1300mm + 400mm & 2400mm H	2250	2500	250	650
Up to 1600mm + 400mm & 2400mm H	2500	2750	250	650

ADDITIONAL HEIGHT OPTIONS

Height Above 2400mm	POA	POA	POA	POA
---------------------	-----	-----	-----	-----

ADDITIONAL END PANEL OPTIONS

Up to 1000mm W & 2400mm H	1000	1200	N/A	N/A
Up to 1400mm W & 2400mm H	1200	1400	N/A	N/A
Up to 1600mm W & 2400mm H	1300	1500	N/A	N/A

ADDITIONAL GLASS OPTIONS

Opti Clear, Bronze, Smoked Black & Satin Etched	300	300	N/A	N/A
---	-----	-----	-----	-----

Where an installation is a 2 man installation, there will be an additional £200 Exc VAT added and can be removed if a qualified personnel is on site to assist. All wall hinges must be secured to a reinforced wall. For large panel installations three hinges may be required.

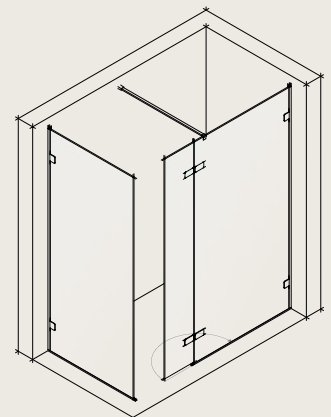

BESPOKE ARYSTO TEN - 3 PANEL SLIDER

All prices below include unlimited notch/cuts

DIMENSIONS	CHROME Exc. VAT	COLOUR Exc. VAT	MEASURE Exc. VAT	INSTALLATION Exc. VAT
Up to 1200mm W & 2400mm H	2200	N/A	250	750
Up to 1400mm W & 2400mm H	2400	N/A	250	750
Up to 1600mm W & 2400mm H	2600	N/A	250	750
Up to 1800mm W & 2400mm H	2800	N/A	250	750
ADDITIONAL HEIGHT OPTIONS				
Max Height 2400mm	POA	N/A	N/A	N/A
SIDE PANEL OPTIONS				
Up to 700mm W & 2400mm H	700	N/A	N/A	N/A
Up to 760mm W & 2400mm H	750	N/A	N/A	N/A
Up to 800mm W & 2400mm H	800	N/A	N/A	N/A
Up to 900mm W & 2400mm H	900	N/A	N/A	N/A
Up to 1000mm W & 2400mm H	1000	N/A	N/A	N/A
ADDITIONAL GLASS OPTIONS				
Opti Clear, Bronze, Smoked Black & Satin Etched	350	N/A	N/A	N/A

Where an installation is a 2 man installation, there will be an additional £200 Exc VAT added and can be removed if a qualified personnel is on site to assist. All wall hinges must be secured to a reinforced wall. For large panel installations three hinges may be required.

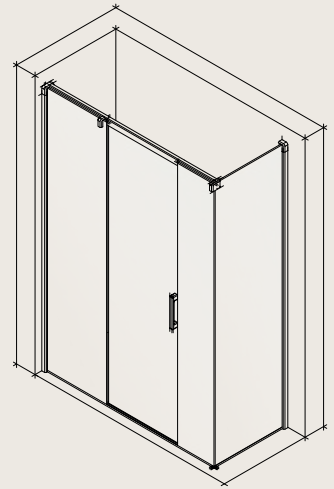

Please note: measure & fit prices will be provided by chosen retailer. For side panels that require joining there are 2 install options available. Standard fit is provided with a tape joint & top bracket whereas UV bond is a seamless joint which is UV bonded using adhesive cured by ultra violet light.

Arysto Bespoke Product Pricing

- » Before we are able to survey your site, your shower tray must be fully installed and all wall tiles finished.
- » It is essential due to the weight of the glass that there is sufficient grounds for fixing all hinges and brackets to all walls and ceilings where appropriate.
- » Cost of the installation may increase due to: weight of the glass panels, increase size of the glass panels or restricted access to site.
- » Satin glass is satin on one side only. If the satin side gets wet the glass will become transparent

Survey & Fitting Service

- » We will visit your home to discuss design options, preferences & advise bespoke options available.
- » Your bespoke shower enclosure will be manufactured to the precise measurements taken, while keeping in mind your discussed design needs, to ensure that we provide the best possible solution for you.
- » Units over 2000mm high may require a two man install charge which will be highlighted after site survey.

Terms & Conditions

- » A decision maker must be present at both survey & installation for confirmation & sign off of specification of the MERLYN bespoke unit.

- » We require 2 days for cancellation or re-booking of visits. Both surveys & installation cancellations will be charged outside of this notice period.

Oversized Panels

- » Panels over 2.3m Height or 70kg are considered oversized. They will require extra care & handling on delivery so will incur an oversized delivery charge.
- » Oversized delivery for oversized units will be highlighted when sent back with layout for sign off after site survey.
- » N.B. We strongly recommend that you use a MERLYN recognised Surveyor and Fitter. CAD or scaled drawings are required especially for sloping panels and panels with dwarf walls. All drawings need to be signed off.

ADDITIONAL COMPONENTS

Ceiling brackets	Gap is 15mm as standard when ceiling bracket is used.	1 INC
Standard towel rail - Chrome Only		130
Shelf - Chrome Only		120
Seat - Chrome Only	Material: Gel coated stone resin. Size: 350mm wide x 55mm high. Recommend 450mm from the ground / tray. Min width = 800mm and max width is 900mm. Static (not drop) weight tested to 500KG.	290
Profiles	Standard Wall	INC
	Recessed Floor	INC
	Recessed Wall	INC
	Standard Wetroom Floor	INC



ARYSTO EIGHT

The Red Dot award winning ARYSTO EIGHT range elevates any space it occupies. Subtle design detailing has been used to enhance the virtually frameless quality of the range. The chamfered edges of the ultra slim frame reflect ambient light reducing the visual impact of the enclosures.

Every detail has been very carefully designed within this range - many of the standard design features have been redeveloped to ensure we maintained the integrity of the design and aesthetic we set out to achieve.



reddot design award
winner 2018





Sliding Door with Side Panel Shown as Right Hand (R)



SLIDING DOOR

Features

- » Virtually frameless - ultra slim profiles and subtle design detailing enhances the quality of this enclosure.
- » Ultra smooth rolling action ensures this door effortlessly glides open and close
- » Easy clean glass with Mershield Stayclear™, revolutionary self cleaning rollers* and fully concealed fixings minimises cleaning time.
- » Soft close door - a natural but solid closing door with no bounce back on closing.
- » Reversible.

SLIDING DOOR IN RECESS

Size	Code	Adjustment Min-Max	Door Opening X	Moving Panel A	Fixed Panel B	Price £ Exc. VAT	Price £ Inc. VAT
1000	AR8SL100REC	950-990	365-385	516	428	1155.83	1387.00
1100	AR8SL110REC	1050-1090	415-435	566	478	1155.83	1387.00
1200	AR8SL120REC	1150-1190	470-490	616	528	1155.83	1387.00
1300	AR8SL130REC	1250-1290	465-485	667	626	1455.83	1747.00
1400	AR8SL140REC	1350-1390	515-535	716	628	1455.83	1747.00
1500	AR8SL150REC	1450-1490	565-585	716	728	1496.67	1796.00
1600	AR8SL160REC	1550-1590	565-585	716	828	1537.50	1845.00
1700	AR8SL170REC	1650-1690	565-585	716	928	1605.00	1926.00

Reversible. Please Note: Images are for illustrative purposes only. Please refer to the installation guide when fitting the product.

SLIDING DOOR FOR USE WITH SIDE PANEL

Size	Code	Adjustment Min-Max	Door Opening X	Moving Panel A	Fixed Panel B	Price £ Exc. VAT	Price £ Inc. VAT
1000	AR8SL100SP	970-990	384	516	428	1155.83	1387.00
1100	AR8SL110SP	1070-1090	434	566	478	1155.83	1387.00
1200	AR8SL120SP	1170-1190	484	616	528	1155.83	1387.00
1300	AR8SL130SP	1270-1290	534	667	626	1455.83	1747.00
1400	AR8SL140SP	1370-1390	584	716	628	1455.83	1747.00
1500	AR8SL150SP	1470-1490	584	716	728	1496.67	1796.00
1600	AR8SL160SP	1570-1590	584	716	828	1537.50	1845.00
1700	AR8SL170SP	1670-1690	584	716	928	1605.00	1926.00

Reversible.

SIDE PANEL D – FOR USE WITH SLIDING DOOR ONLY

Size	Code	Adjustment Min-Max	Price £ Exc. VAT	Price £ Inc. VAT
700	AR8SPSL70	670-690	611.67	734.00
760	AR8SPSL76	730-750	611.67	734.00
800	AR8SPSL80	770-790	611.67	734.00
900	AR8SPSL90	870-890	652.50	783.00
1000	AR8SPSL100	970-990	720.83	865.00

Reversible. Please Note: The door must close against the Side Panel. Please Note: Images are for illustrative purposes only. Please refer to the installation guide when fitting the product.

Technical Drawing

In Recess



With Side Panel

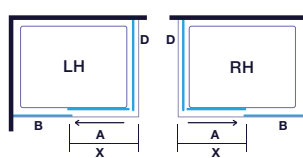

Extension profiles available. See Page 123





Sliding Door shown in Recess shown as Left Hand (L)



Sliding Door with Side Panel shown as Left Hand (L)



LEVEL25

Match our ARYSTO 8 enclosures with our Level25 trays for that luxurious look.



ONE DOOR QUADRANT

Features

- » Virtually frameless - ultra slim profiles and subtle design detailing enhances the quality of this enclosure.
- » Ultra smooth rolling action ensures this door effortlessly glides open and closed.
- » Easy clean glass with Mershield Stayclear™, revolutionary self cleaning rollers* and fully concealed fixings minimises cleaning time.
- » Soft close door - a natural but solid closing door with no bounce back on closing.

ONE DOOR QUADRANT							
Size	Code	Adjustment Min-Max	Door Opening X	Flat Fixed Panel B	Curved Fixed Panel C	Price £ Exc. VAT	Price £ Inc. VAT
800 x 800	AR81Q800 (L or R)	770-790	430	210	510	1360.00	1632.00
900 x 900	AR81Q900 (L or R)	870-890	470	310	570	1360.00	1632.00
1000 x 1000	AR81Q1000 (L or R)	970-990	470	410	670	1496.67	1796.00

ONE DOOR OFFSET QUADRANT							
Size	Code	Adjustment Min-Max	Door Opening X	Flat Fixed Panel B	Curved Fixed Panel C	Price £ Exc. VAT	Price £ Inc. VAT
900 x 760	AR81Q976 (L or R)	870-890 / 730-750	415	310	490	1564.17	1877.00
1000 x 800	AR81Q1080 (L or R)	970-990 / 770-790	430	410	510	1564.17	1877.00
1200 x 800	AR81Q1280 (L or R)	1170-1190 / 770-790	430	610	510	1564.17	1877.00
1200 x 900	AR81Q1290 (L or R)	1170-1190 / 870-890	470	610	570	1564.17	1877.00
1400 x 800	AR81Q1480 (L or R)	1370-1390 / 770-790	430	810	510	1632.50	1959.00

This product is handed – please choose L for Left and R for Right when ordering. Please Note: Images are for illustrative purposes only. Please refer to the installation guide when fitting the product.



One Door Offset Quadrant shown as Left Hand (L)

Technical Drawing

One Door Quadrant

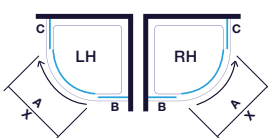

One Door Offset Quadrant



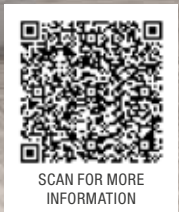

One Door Quadrant shown as Left Hand (L)



LEVEL 25

Match our ARYSTO 8 enclosures with our Level25 trays for that luxurious look.

Trays ...



INFOLD DOOR

Features

- » Space saving solution - perfect for bathrooms tight on space, this door opens inwards minimising the outward opening space required.
- » Easy clean glass with Mershield Stayclear™ and fully concealed fixings minimises cleaning time.
- » Virtually frameless - ultra slim profiles and subtle design details enhance the frameless quality of this enclosure.
- » Ultra smooth opening action ensures this door effortlessly glides open and closed.

INFOLD DOOR IN RECESS

Size	Code	Adjustment Min-Max	Door Opening X	Outside Door Swing Y	Inside Door Swing Z	Price £ Exc. VAT	Price £ Inc. VAT
700	AR8NF70 (L or R)	650-690	440-460	211	420	1088.33	1306.00
760	AR8NF76 (L or R)	710-750	500-520	271	420	1088.33	1306.00
800	AR8NF80 (L or R)	750-790	540-560	311	420	1088.33	1306.00
900	AR8NF90 (L or R)	850-890	640-660	411	420	1101.67	1322.00
1000	AR8NF100 (L or R)	950-990	740-760	511	420	1183.33	1420.00

This product is handed - please choose L for Left and R for Right when ordering. Please Note: Images are for illustrative purposes only. Please refer to the installation guide when fitting the product.

INFOLD DOOR FOR USE WITH SIDE PANEL

Size	Code	Adjustment Min-Max	Door Opening X	Outside Door Swing Y	Inside Door Swing Z	Price £ Exc. VAT	Price £ Inc. VAT
700	AR8NF70 (L or R)	655-675	468	211	420	1088.33	1306.00
760	AR8NF76 (L or R)	715-735	528	271	420	1088.33	1306.00
800	AR8NF80 (L or R)	755-775	568	311	420	1088.33	1306.00
900	AR8NF90 (L or R)	855-875	668	411	420	1101.67	1322.00
1000	AR8NF100 (L or R)	955-975	768	511	420	1183.33	1420.00

This product is handed - please choose L for Left and R for Right when ordering. Please Note: Images are for illustrative purposes only. Please refer to the installation guide when fitting the product.

SIDE PANEL D – FOR USE WITH INFOLD DOOR ONLY

Size	Code	Adjustment Min-Max	Price £ Exc. VAT	Price £ Inc. VAT
700	AR8SP70NF	670-690	611.67	734.00
760	AR8SP76NF	730-750	611.67	734.00
800	AR8SP80NF	770-790	611.67	734.00
900	AR8SP90NF	870-890	652.50	783.00
1000	AR8SP100NF	970-990	720.83	865.00
1200	AR8SP120NF	1170-1190	815.83	979.00

Reversible. Please Note: Images are for illustrative purposes only. Please refer to the installation guide when fitting the product.

Technical Drawing

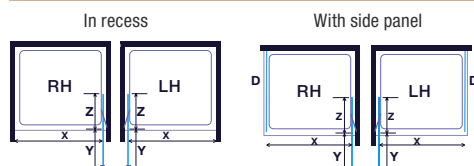

Extension profiles available. See Page 123





reddot award 2018
winner

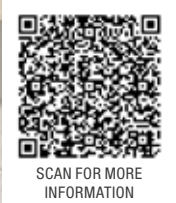

Infold Door in Recess shown as Left Hand (L)



Infold Door with Side Panel shown as Right Hand (R) - Overhead



LEVEL25

Match our ARYSTO 8 enclosures with our Level25 trays for that luxurious look.



INFOLD DOOR WITH INLINE PANEL

Features

- » Space saving solution - perfect for bathrooms tight on space, this door opens inwards minimising the outward opening space required.
- » Easy clean glass with Mershield Stayclear™ and fully concealed fixings minimises cleaning time.
- » Virtually frameless - ultra slim profiles and subtle design details enhance the frameless quality of this enclosure.
- » Ultra smooth opening action ensures this door effortlessly glides open and closed.

INFOLD DOOR WITH INLINE PANEL

Size	Code	Adjustment in Recess Min-Max	Adjustment with Side Panel Min-Max	Door Opening X	Outside Door Swing Y	Inside Door Swing Z	Price £ Exc. VAT	Price £ Inc. VAT
900	AR8NN9002H (L or R)	860-900	860-880	480	211	420	1487.50	1785.00
960	AR8NN9602H (L or R)	920-960	920-940	540	271	420	1487.50	1785.00
1000	AR8NN1002H (L or R)	960-1000	960-980	580	311	420	1487.50	1785.00
1100	AR8NN1104H (L or R)	1060-1100	1060-1080	480	211	420	1554.17	1865.00
1160	AR8NN1164H (L or R)	1120-1160	1120-1140	540	271	420	1554.17	1865.00
1200	AR8NN1204H (L or R)	1160-1200	1160-1180	580	311	420	1554.17	1865.00
1300	AR8NN1306H (L or R)	1260-1300	1260-1280	480	411	420	1620.83	1945.00
1360	AR8NN1366H (L or R)	1320-1360	1320-1340	540	211	420	1620.83	1945.00
1400	AR8NN1406H (L or R)	1360-1400	1360-1380	580	371	420	1620.83	1945.00
1500	AR8NN1506H (L or R)	1460-1500	1460-1480	680	411	420	1634.17	1961.00
1600	AR8NN1606H (L or R)	1560-1600	1560-1580	780	511	420	1715.00	2058.00

Please Note: Images are for illustrative purposes only. Please refer to the installation guide when fitting the product. This product is handed – please choose L for Left and R for Right when ordering. Please Note: The door must close against the Inline Panel.

SIDE PANEL

Size	Code	Adjustment Min-Max	Price £ Exc. VAT	Price £ Inc. VAT
700	AR8SPN70H	655-675	660.83	793.00
760	AR8SPN76H	715-735	660.83	793.00
800	AR8SPN80H	755-775	660.83	793.00
900	AR8SPN90H	855-875	701.67	842.00
1000	AR8SPN100H	955-975	770.00	924.00
1200	AR8SPN120H	1155-1175	865.00	1038.00

Technical Drawing

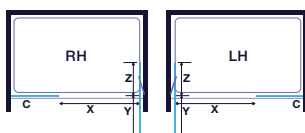



reddot award 2018
winner

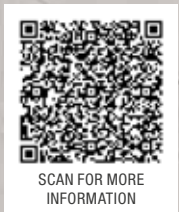

SCAN FOR MORE
INFORMATION

Sliding Door with Inline Panel shown as Right Hand (R)



LEVEL25

Match our ARYSTO 8 enclosures with our Level25 trays for that luxurious look.

Trays ...

ARYSTO SLEEK

Luxury Refreshed

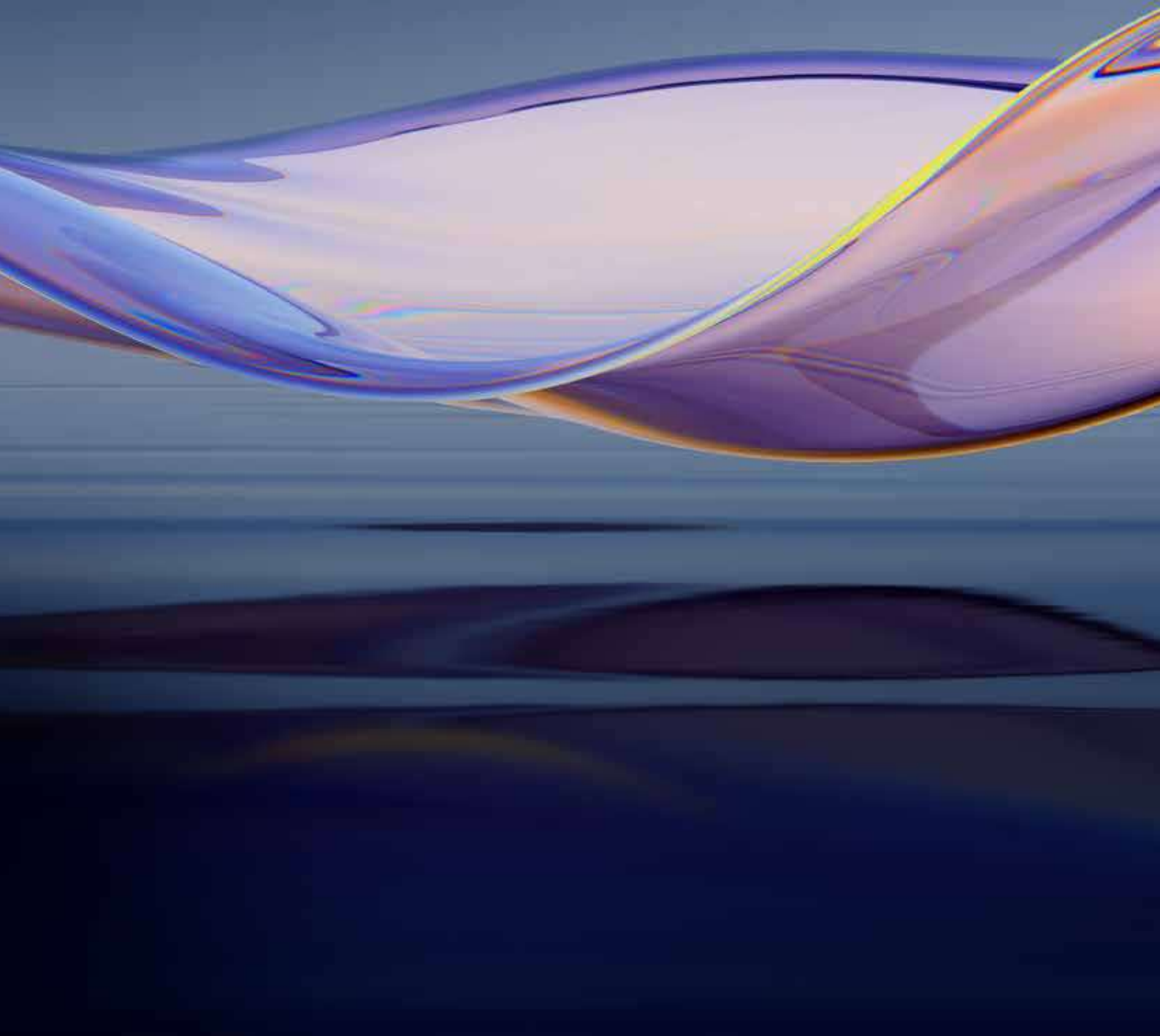

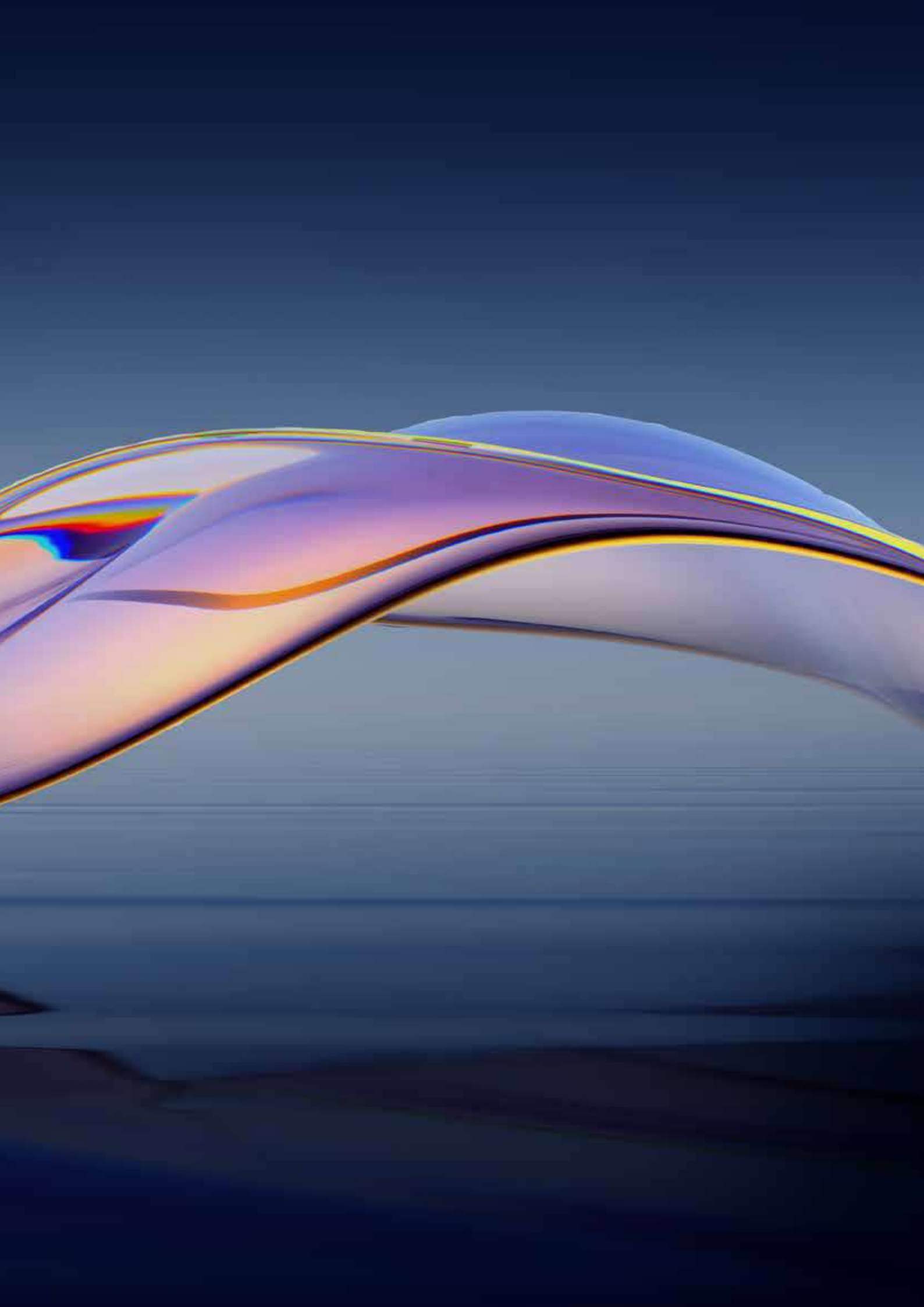



ARYSTO SLEEK

There's nothing quite like stepping into a beautiful bathroom. Many of us are recreating this room as we increasingly value the importance of wellness, relaxation, and self-care. Our stunning Arysto Sleek range is designed to act as a centrepiece in any bathroom.

Every size is now available in five beautiful finishes: Brushed Brass, Matt Black, Brushed Gun Metal, Brushed Nickel, and Chrome - for a beautifully curated finish in any bathroom.

Discover the perfect match for your space.



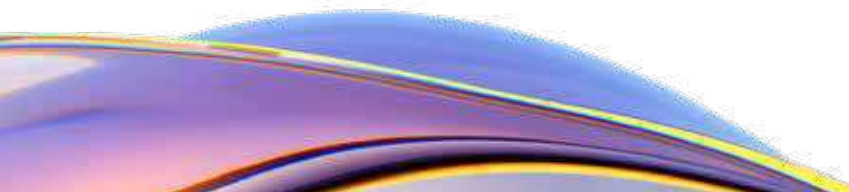

FEATURES & BENEFITS



Easy to clean and maintain - Mershield Stayclear™ invisible protective glass coating prevents the build-up of limescale and soap to keep your shower enclosure looking like new for longer.



Lifetime Guarantee - MERLYN is committed to developing products that meet the highest standards. We are so confident in our products and service, that we offer a lifetime guarantee.



Reversible door - Arysto Sleek doors can be fitted for either left or right hand entry depending on the bathroom design and layout.



Cover Caps - A stylish design with discrete, hidden fixings and no visible screw holes for a clean, premium finish.



Quick release rollers - Our Sliding and Quadrant door options feature quick - release bottom rollers for easy cleaning.



Recyclable packaging - Delivered safely and securely with minimal packaging and no single use plastics.



Soft close - The door opens and shuts with virtually no sound, making it the perfect choice for family bathrooms.



Multi-purpose - Suitable for wetroom and shower tray application.



Anodised finish - The colour layer is fully integrated with the underlying aluminium substrate, so it cannot chip or peel. Making it more durable than powder coating.



Handles - Our Chrome products have a solid metal chrome handle. Matt Black and Brushed Brass have a double metal handle.

Quick and easy installation - Our Sliding, Quadrant, Hinge and Infold shower enclosures can be installed in two simple steps.



COLOURED FINISHES

Create a bathroom that's as unique and individual as you with our collection of four stunning contemporary colours.

Colour Options...

				
Brushed Brass (BBR)	Standard Chrome	Matt Black (MB)	NEW Brushed Gun Metal (BGM)	Brushed Nickel (BN)

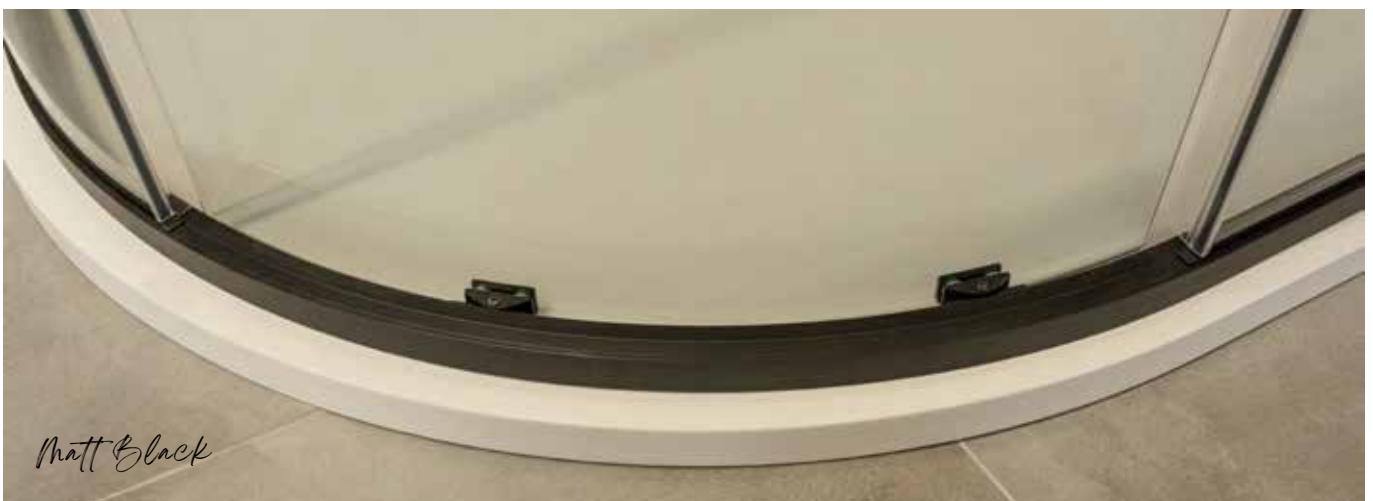



SLIDING DOOR

CAN BE FITTED WITH TWO SIDE PANELS

The Arysto Sleek Sliding door is our classic shower enclosure option with a new minimalist, modern design. Crafted using the finest materials for an incredibly smooth-gliding door, it is perfect for smaller spaces and alcoves, or used in conjunction with our side panels to create stand-alone enclosures.

Brushed Nickel and Brushed Gun Metal are available on the next page.

SLIDING DOOR IN MATT BLACK, BRUSHED BRASS & CHROME

Size	Code	Adjustment in Recess Min-Max	Adjustment with Side Panel Min-Max	Door Opening X	Moving Panel A	Fixed Panel B	Chrome Pricing		Matt Black Pricing (MB)		Brushed Brass Pricing (BBR)	
							Price £ Exc. VAT	Price £ Inc. VAT	Price £ Exc. VAT	Price £ Inc. VAT	Price £ Exc. VAT	Price £ Inc. VAT
1000	AS10	950-990	953-993	375	506	430	762.50	915.00	845.83	1015.00	962.50	1155.00
1100	AS11	1050-1090	1053-1093	425	556	480	770.00	924.00	850.00	1020.00	967.50	1161.00
1200	AS12	1150-1190	1153-1193	475	606	530	777.50	933.00	855.00	1026.00	973.33	1168.00
1400	AS14	1350-1390	1353-1393	575	706	630	881.67	1058.00	968.33	1162.00	1100.00	1320.00
1500	AS15	1450-1490	1453-1493	575	706	730	981.67	1178.00	1079.17	1295.00	1227.50	1473.00
1600	AS16	1550-1590	1553-1593	575	706	830	1100.83	1321.00	1210.00	1452.00	1376.67	1652.00
1700	AS17	1650-1690	1653-1693	575	706	930	1211.67	1454.00	1331.67	1598.00	1515.00	1818.00

Door is reversible. Side & fixed panels come in 6mm glass. Sliding door can be fitted with two side panels (max size 1700mm slider with 1000mm side panel).

SIDE PANEL IN MATT BLACK, BRUSHED BRASS & CHROME

Size	Code	Adjustment Min-Max	Chrome Pricing		Matt Black Pricing (MB)		Brushed Brass Pricing (BBR)	
			Price £ Exc. VAT	Price £ Inc. VAT	Price £ Exc. VAT	Price £ Inc. VAT	Price £ Exc. VAT	Price £ Inc. VAT
760	ASP76	730-750	408.33	490.00	455.83	547.00	517.50	621.00
800	ASP80	770-790	412.50	495.00	460.00	552.00	524.17	629.00
900	ASP90	870-890	440.00	528.00	482.50	579.00	550.00	660.00
1000	ASP10	970-990	555.00	666.00	628.33	754.00	714.17	857.00
1200	ASP12	1170-1190	560.83	673.00	650.00	780.00	734.17	881.00

Door is reversible. Side panels come in 6mm glass.

Handles



Chrome Handles
Solid metal handle with a chrome finish.

Colour Handles
Double metal handle with colour finish.

Technical Drawing

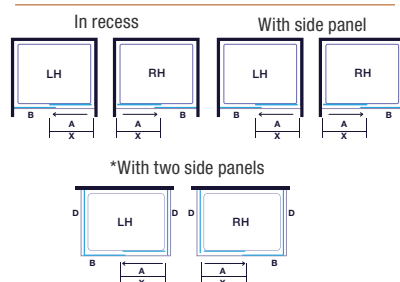

*Add 6mm to recess adjustment. Max side panel size is 1000mm when using two side panels

Colour Finishes; Express Yourself

When ordering your door please use the correct code to the size required. Then add the colour code you need.

Example: AS10 is the standard chrome code add **MB** for Matt Black, **BBR** for Brushed Brass, **BN** for Brushed Nickel or **BGM** for Brushed Gun Metal.

Example: AS10 + MB (Matt Black) = AS10MB.
Chrome option is your standard code.



Extension profiles available. See Page 123



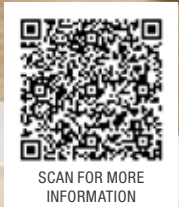

SCAN FOR MORE
INFORMATION

Sliding Door with Side Panel shown as Left Hand (L) - Shown in Matt Black



 **TRUESTONE**[®]

Match our ARYSTO SLEEK enclosures with our Truestone trays for that all inspiring look and feel.



SLIDING DOOR - NEW COLOURS

CAN BE FITTED WITH TWO SIDE PANELS

The Arysto Sleek Sliding door is our classic shower enclosure option with a new minimalist, modern design. Crafted using the finest materials for an incredibly smooth-gliding door, it is perfect for smaller spaces and alcoves, or used in conjunction with our side panels to create stand-alone enclosures.

SLIDING DOOR IN BRUSHED NICKEL & BRUSHED GUN METAL

Size	Code	Adjustment in Recess Min-Max	Adjustment with Side Panel Min-Max	Door Opening X	Moving Panel A	Fixed Panel B	Brushed Nickel Pricing (BN)		Brushed Gun Metal Pricing (BGM)	
							Price £ Exc. VAT	Price £ Inc. VAT	Price £ Exc. VAT	Price £ Inc. VAT
1000	AS10	950-990	953-993	375	506	430	962.50	1155.00	962.50	1155.00
1100	AS11	1050-1090	1053-1093	425	556	480	967.50	1161.00	967.50	1161.00
1200	AS12	1150-1190	1153-1193	475	606	530	973.33	1168.00	973.33	1168.00
1400	AS14	1350-1390	1353-1393	575	706	630	1100.00	1320.00	1100.00	1320.00
1500	AS15	1450-1490	1453-1493	575	706	730	1227.50	1473.00	1227.50	1473.00
1600	AS16	1550-1590	1553-1593	575	706	830	1376.67	1652.00	1376.67	1652.00
1700	AS17	1650-1690	1653-1693	575	706	930	1515.00	1818.00	1515.00	1818.00

Door is reversible. Side & fixed panels come in 6mm glass. Sliding door can be fitted with two side panels (max size 1700mm slider with 1000mm side panel).

SIDE PANEL IN BRUSHED NICKEL & BRUSHED GUN METAL

Size	Code	Adjustment Min-Max	Brushed Nickel Pricing (BN)		Brushed Gun Metal Pricing (BGM)	
			Price £ Exc. VAT	Price £ Inc. VAT	Price £ Exc. VAT	Price £ Inc. VAT
760	ASP76	730-750	517.50	621.00	517.50	621.00
800	ASP80	770-790	524.17	629.00	524.17	629.00
900	ASP90	870-890	550.00	660.00	550.00	660.00
1000	ASP10	970-990	714.17	857.00	714.17	857.00
1200	ASP12	1170-1190	733.33	880.00	733.33	880.00

Door is reversible.

Handles



Chrome
Solid metal handle with a chrome finish.

Colour Handles
Double metal handle with colour finish.

Technical Drawing

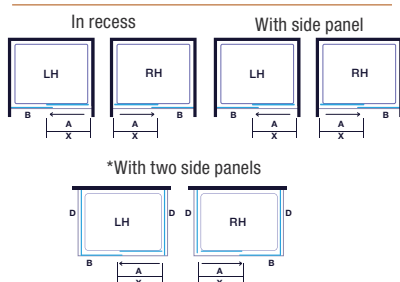

*Add 6mm to recess adjustment. Max side panel size is 1000mm when using two side panels

Colour Finishes; Express Yourself

When ordering your door please use the correct code to the size required. Then add the colour code you need.

Example: AS10 is the standard chrome code add **MB** for Matt Black, **BBR** for Brushed Brass, **BN** for Brushed Nickel or **BGM** for Brushed Gun Metal.

Example: AS10 + MB (Matt Black) = AS10MB.
Chrome option is your standard code.



Extension profiles available. See Page 123



NEW!

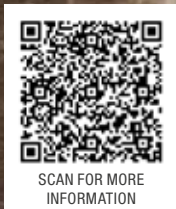
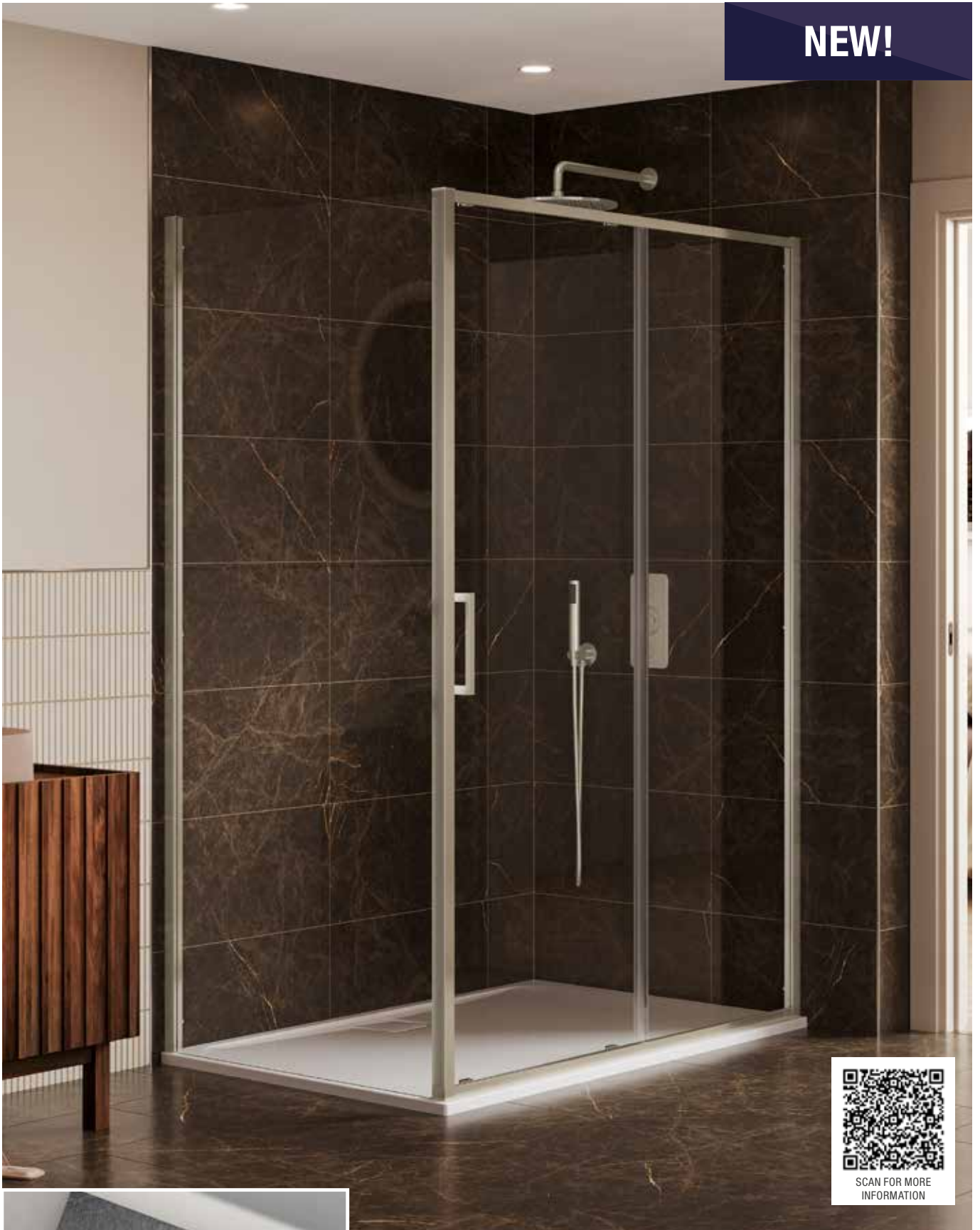

SCAN FOR MORE INFORMATION

Sliding Door with Side Panel shown as Right Hand (R) - Shown in Brushed Nickel



TRUESTONE®

Match our ARYSTO SLEEK enclosures with our Truestone trays for that all inspiring look and feel.



INFOLD DOOR

The Arysto Sleek Infold door is the perfect space saving design for smaller spaces. It features an innovative Infold door mechanism with a very slim, hidden profile to maximise the opening width into the shower enclosure.

Brushed Nickel and Brushed Gun Metal are available on the next page.

INFOLD DOOR IN MATT BLACK, BRUSHED BRASS & CHROME

Size	Code	Adjustment in Recess Min-Max	Adjustment with Side Panel Min-Max	Door Opening X	Outside Door Swing Y	Inside Door Swing Z	Chrome Pricing		Matt Black Pricing (MB)		Brushed Brass Pricing (BBR)	
							Price £ Exc. VAT	Price £ Inc. VAT	Price £ Exc. VAT	Price £ Inc. VAT	Price £ Exc. VAT	Price £ Inc. VAT
760	ANF76	710-750	713-753	515	175	460	712.50	855.00	780.83	937.00	886.67	1064.00
800	ANF80	750-790	753-793	555	215	460	712.50	855.00	792.50	951.00	898.33	1078.00
900	ANF90	850-890	853-893	655	315	460	734.17	881.00	815.83	979.00	925.00	1110.00
1000	ANF10	950-990	953-993	755	415	460	763.33	916.00	850.83	1021.00	971.67	1166.00

Door is reversible.

SIDE PANEL IN MATT BLACK, BRUSHED BRASS & CHROME

Size	Code	Adjustment Min-Max	Chrome Pricing		Matt Black Pricing (MB)		Brushed Brass Pricing (BBR)	
			Price £ Exc. VAT	Price £ Inc. VAT	Price £ Exc. VAT	Price £ Inc. VAT	Price £ Exc. VAT	Price £ Inc. VAT
760	ASP76	730-750	408.33	490.00	455.83	547.00	517.50	621.00
800	ASP80	770-790	412.50	495.00	460.00	552.00	524.17	629.00
900	ASP90	870-890	440.00	528.00	482.50	579.00	550.00	660.00
1000	ASP10	970-990	555.00	666.00	628.33	754.00	714.17	857.00
1200	ASP12	1170-1190	560.83	673.00	650.00	780.00	734.17	881.00

Door is reversible.



Infold Door in Recess

Handles



Chrome
Solid metal handle with a chrome finish.

Colour Handles
Double metal handle with colour finish.

Technical Drawing

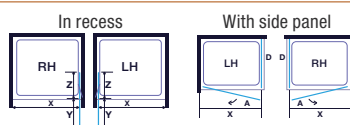

Colour Finishes; Express Yourself

When ordering your door please use the correct code to the size required. Then add the colour code you need.

Example: ANF76 is the standard chrome code add **MB** for Matt Black, **BBR** for Brushed Brass, **BN** for Brushed Nickel or **BGM** for Brushed Gun Metal.

Example: ANF76 + MB (Matt Black) = ANF76MB.
Chrome option is your standard code.



Extension profiles available. See Page 123



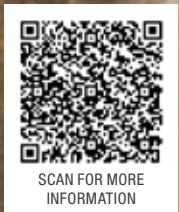

SCAN FOR MORE
INFORMATION

Infold Door with Side Panel shown as Left Hand (L) - Shown in Brushed Brass



 TRUESTONE®

Match our ARYSTO SLEEK
enclosures with our Truestone trays
for that all inspiring look and feel.



INFOLD DOOR - NEW COLOURS

The Arysto Sleek Infold door is the perfect space saving design for smaller spaces. It features an innovative Infold door mechanism with a very slim, hidden profile to maximise the opening width into the shower enclosure.

INFOLD DOOR IN BRUSHED NICKEL & BRUSHED GUN METAL

Size	Code	Adjustment in Recess Min-Max	Adjustment with Side Panel Min-Max	Door Opening X	Outside Door Swing Y	Inside Door Swing Z	Brushed Nickel Pricing (BN)		Brushed Gun Metal Pricing (BGM)	
							Price £ Exc. VAT	Price £ Inc. VAT	Price £ Exc. VAT	Price £ Inc. VAT
760	ANF76	710-750	713-753	515	175	460	885.83	1063.00	885.83	1063.00
800	ANF80	750-790	753-793	555	215	460	898.33	1078.00	898.33	1078.00
900	ANF90	850-890	853-893	655	315	460	925.00	1110.00	925.00	1110.00
1000	ANF10	950-990	953-993	755	415	460	971.67	1166.00	971.67	1166.00

Door is reversible.

SIDE PANEL IN BRUSHED NICKEL & BRUSHED GUN METAL

Size	Code	Adjustment Min-Max	Brushed Nickel Pricing (BN)		Brushed Gun Metal Pricing (BGM)	
			Price £ Exc. VAT	Price £ Inc. VAT	Price £ Exc. VAT	Price £ Inc. VAT
760	ASP76	730-750	517.50	621.00	517.50	621.00
800	ASP80	770-790	524.17	629.00	524.17	629.00
900	ASP90	870-890	550.00	660.00	550.00	660.00
1000	ASP10	970-990	714.17	857.00	714.17	857.00
1200	ASP12	1170-1190	733.33	880.00	733.33	880.00

Door is reversible.



Infold Door in Recess

Handles



Chrome
Solid metal handle with a chrome finish.

Colour Handles
Double metal handle with colour finish.

Technical Drawing

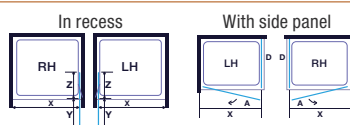

Colour Finishes; Express Yourself

When ordering your door please use the correct code to the size required. Then add the colour code you need.

Example: ANF76 is the standard chrome code add **MB** for Matt Black, **BBR** for Brushed Brass, **BN** for Brushed Nickel or **BGM** for Brushed Gun Metal.

Example: ANF76 + MB (Matt Black) = ANF76MB.
Chrome option is your standard code.



Extension profiles available. See Page 123

NEW!

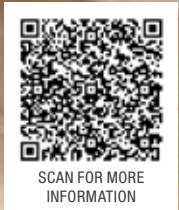

SCAN FOR MORE
INFORMATION

Infold Door with Side Panel shown as Left Hand (L) - Shown in Gun Metal



TRUESTONE®

Match our ARYSTO SLEEK enclosures with our Truestone trays for that all inspiring look and feel.



QUADRANT DOORS

Arysto Sleek Quadrant shower enclosures fit snugly into any right angle corner of the bathroom to give a generous showering space with a stylish curved shower edge. This shape is perfect for small and large bathrooms.

Brushed Nickel and Brushed Gun Metal are available on the next page.

ONE DOOR QUADRANT IN MATT BLACK, BRUSHED BRASS & CHROME

Size	Code	Adjustment Min-Max	Door Opening X	Moving Panel A	Fixed Panel B	Fixed Panel C	Chrome Pricing		Matt Black Pricing (MB)		Brushed Brass Pricing (BBR)	
							Price £ Exc. VAT	Price £ Inc. VAT	Price £ Exc. VAT	Price £ Inc. VAT	Price £ Exc. VAT	Price £ Inc. VAT
900 x 900	A1Q90	870-890 / 870-890	488	615	515	350	871.67	1046.00	976.67	1172.00	1109.17	1331.00
1000 x 1000	A1Q10	970-990 / 970-990	488	615	615	450	881.67	1058.00	988.33	1186.00	1120.83	1345.00

ONE DOOR OFFSET QUADRANT IN MATT BLACK, BRUSHED BRASS & CHROME

1000 x 800	A1Q1080	970-990 / 770-790	435	561	470	450	917.50	1101.00	1027.50	1233.00	1169.17	1403.00
1200 x 800	A1Q1280	1170-1190 / 770-790	435	561	470	650	973.33	1168.00	1070.83	1285.00	1219.17	1463.00
1200 x 900	A1Q1290	1170-1190 / 870-890	488	615	515	650	1019.17	1223.00	1120.00	1344.00	1271.67	1526.00

Door is reversible. Fixed panels come in 6mm glass.

TWO DOOR QUADRANT IN MATT BLACK, BRUSHED BRASS & CHROME

Size	Code	Adjustment Min-Max	Door Opening X	Moving Panel A	Straight Panel B	Chrome Pricing		Matt Black Pricing (MB)		Brushed Brass Pricing (BBR)	
						Price £ Exc. VAT	Price £ Inc. VAT	Price £ Exc. VAT	Price £ Inc. VAT	Price £ Exc. VAT	Price £ Inc. VAT
800 x 800	A2Q80	770-790 / 770-790	392	400	220	815.83	979.00	890.83	1069.00	1012.50	1215.00
900 x 900	A2Q90	870-890 / 870-890	542	400	320	815.83	979.00	920.83	1105.00	1047.50	1257.00

Door is reversible. Fixed panels come in 6mm glass.



Two Door Quadrant - Shown in Matt Black

Handles



Chrome
Solid metal handle with a chrome finish.

Colour Handles
Double metal handle with colour finish.

Technical Drawing

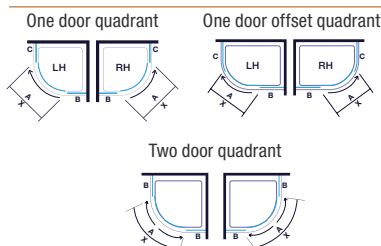

Colour Finishes; Express Yourself

When ordering your door please use the correct code to the size required. Then add the colour code you need.

Example: A1Q90 is the standard chrome code add **MB** for Matt Black, **BBR** for Brushed Brass, **BN** for Brushed Nickel or **BGM** for Brushed Gun Metal.

Example: A1Q90 + MB (Matt Black) = A1Q90MB.
Chrome option is your standard code.



Extension profiles available. See Page 123



One Door Offset Quadrant Shown as Left Hand (L) - Shown in Brushed Brass



TRUESTONE®

Match our ARYSTO SLEEK enclosures with our Truestone trays for that all inspiring look and feel.



QUADRANT DOORS - NEW COLOURS

Arysto Sleek Quadrant shower enclosures fit snugly into any right angle corner of the bathroom to give a generous showering space with a stylish curved shower edge. This shape is perfect for small and large bathrooms.

ONE DOOR QUADRANT IN BRUSHED NICKEL & BRUSHED GUN METAL

Size	Code	Adjustment Min-Max	Door Opening X	Moving Panel A	Fixed Panel B	Fixed Panel C	Brushed Nickel Pricing (BN)		Brushed Gun Metal Pricing (BGM)	
							Price £ Exc. VAT	Price £ Inc. VAT	Price £ Exc. VAT	Price £ Inc. VAT
900 x 900	A1Q90	870-890 / 870-890	488	615	515	350	1109.17	1331.00	1109.17	1331.00
1000 x 1000	A1Q10	970-990 / 970-990	488	615	615	450	1120.83	1345.00	1120.83	1345.00

ONE DOOR OFFSET QUADRANT IN BRUSHED NICKEL & BRUSHED GUN METAL

Size	Code	Adjustment Min-Max	Door Opening X	Moving Panel A	Straight Panel B	Brushed Nickel Pricing (BN)		Brushed Gun Metal Pricing (BGM)		
						Price £ Exc. VAT	Price £ Inc. VAT	Price £ Exc. VAT	Price £ Inc. VAT	
1000 x 800	A1Q1080	970-990 / 770-790	435	561	470	450	1169.17	1403.00	1169.17	1403.00
1200 x 800	A1Q1280	1170-1190 / 770-790	435	561	470	650	1218.33	1462.00	1218.33	1462.00
1200 x 900	A1Q1290	1170-1190 / 870-890	488	615	515	650	1271.67	1526.00	1271.67	1526.00

Door is reversible. Fixed panels come in 6mm glass.

TWO DOOR QUADRANT IN BRUSHED NICKEL & BRUSHED GUN METAL

Size	Code	Adjustment Min-Max	Door Opening X	Moving Panel A	Straight Panel B	Brushed Nickel Pricing (BN)		Brushed Gun Metal Pricing (BGM)		
						Price £ Exc. VAT	Price £ Inc. VAT	Price £ Exc. VAT	Price £ Inc. VAT	
800 x 800	A2Q80	770-790 / 770-790	392	400	220		1011.67	1214.00	1011.67	1214.00
900 x 900	A2Q90	870-890 / 870-890	542	400	320		1047.50	1257.00	1047.50	1257.00

Door is reversible. Fixed panels come in 6mm glass.



One Door Offset Quadrant Shown as Left Hand (L) - Shown in Brushed Nickel

Handles



Chrome
Solid metal handle with a chrome finish.

Colour Handles
Double metal handle with colour finish.

Technical Drawing

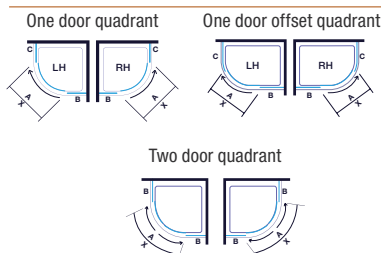

Colour Finishes; Express Yourself

When ordering your door please use the correct code to the size required. Then add the colour code you need.

Example: A1Q90 is the standard chrome code add **MB** for Matt Black, **BBR** for Brushed Brass, **BN** for Brushed Nickel or **BGM** for Brushed Gun Metal.

Example: A1Q90 + MB (Matt Black) = A1Q90MB.
Chrome option is your standard code.



Extension profiles available. See Page 123

NEW!

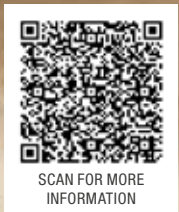

Two Door Quadrant - Shown in Gun Metal



 **TRUESTONE®**

Match our ARYSTO SLEEK enclosures with our Truestone trays for that all inspiring look and feel.



HINGE DOOR

Our fully reversible hinge door with side panel is beautifully designed to give a premium quality finish, with discrete design features. The ultra-slim profile is complimented by slim hinges with concealed fixings for a sleek finish that is easier to clean and maintain.

Our Hinge door comes fully assembled. Brushed Nickel and Brushed Gun Metal are available on the next page.

HINGE DOOR IN MATT BLACK, BRUSHED BRASS & CHROME

Size	Code	Adjustment in Recess Min-Max	Adjustment with Side Panel Min-Max	Door Opening X	Door Swing Y	Chrome Pricing		Matt Black Pricing (MB)		Brushed Brass Pricing (BBR)	
						Price £ Exc. VAT	Price £ Inc. VAT	Price £ Exc. VAT	Price £ Inc. VAT	Price £ Exc. VAT	Price £ Inc. VAT
760	AH76	710-750	713-753	605	620	778.33	934.00	863.33	1036.00	975.83	1171.00
800	AH80	750-790	753-793	645	665	770.83	925.00	871.67	1046.00	985.00	1182.00
900	AH90	850-890	853-893	745	765	817.50	981.00	916.67	1100.00	1037.50	1245.00
1000	AH10	950-990	953-993	845	865	825.00	990.00	941.67	1130.00	1066.67	1280.00

Door is reversible.

SIDE PANEL IN MATT BLACK, BRUSHED BRASS & CHROME

Size	Code	Adjustment Min-Max	Chrome Pricing		Matt Black Pricing (MB)		Brushed Brass Pricing (BBR)	
			Price £ Exc. VAT	Price £ Inc. VAT	Price £ Exc. VAT	Price £ Inc. VAT	Price £ Exc. VAT	Price £ Inc. VAT
760	ASP76	730-750	408.33	490.00	455.83	547.00	517.50	621.00
800	ASP80	770-790	412.50	495.00	460.00	552.00	524.17	629.00
900	ASP90	870-890	440.00	528.00	482.50	579.00	550.00	660.00
1000	ASP10	970-990	555.00	666.00	628.33	754.00	714.17	857.00
1200	ASP12	1170-1190	560.83	673.00	650.00	780.00	734.17	881.00

Door is reversible.



Hinge Door in Recess - Shown in Brushed Brass

Handles



Chrome
Solid metal handle with a chrome finish.

Colour Handles
Double metal handle with colour finish.

Technical Drawing

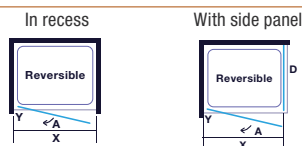

Colour Finishes; Express Yourself

When ordering your door please use the correct code to the size required. Then add the colour code you need.

Example: AH76 is the standard chrome code add **MB** for Matt Black, **BBR** for Brushed Brass, **BN** for Brushed Nickel or **BGM** for Brushed Gun Metal.

Example: AH76 + MB (Matt Black) = AH76MB.
Chrome option is your standard code.



Extension profiles available. See Page 123



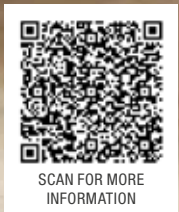

Hinge Door with Side Panel shown as Left Hand (L) - Shown in Matt Black



 TRUESTONE®

Match our ARYSTO SLEEK enclosures with our Truestone trays for that all inspiring look and feel.



HINGE DOOR - NEW COLOURS

Our fully reversible hinge door with side panel is beautifully designed to give a premium quality finish, with discrete design features. The ultra-slim profile is complimented by slim hinges with concealed fixings for a sleek finish that is easier to clean and maintain.

Our Hinge door comes fully assembled.

HINGE DOOR IN BRUSHED NICKEL & BRUSHED GUN METAL

Size	Code	Adjustment in Recess Min-Max	Adjustment with Side Panel Min-Max	Door Opening X	Door Swing Y	Brushed Nickel Pricing (BN)		Brushed Gun Metal Pricing (BGM)	
						Price £ Exc. VAT	Price £ Inc. VAT	Price £ Exc. VAT	Price £ Inc. VAT
760	AH76	710-750	713-753	605	620	975.83	1171.00	975.83	1171.00
800	AH80	750-790	753-793	645	665	985.00	1182.00	985.00	1182.00
900	AH90	850-890	853-893	745	765	1037.50	1245.00	1037.50	1245.00
1000	AH10	950-990	953-993	845	865	1066.67	1280.00	1066.67	1280.00

Door is reversible.

SIDE PANEL IN BRUSHED NICKEL & BRUSHED GUN METAL

Size	Code	Adjustment Min-Max	Brushed Nickel Pricing (BN)		Brushed Gun Metal Pricing (BGM)	
			Price £ Exc. VAT	Price £ Inc. VAT	Price £ Exc. VAT	Price £ Inc. VAT
760	ASP76	730-750	517.50	621.00	517.50	621.00
800	ASP80	770-790	524.17	629.00	524.17	629.00
900	ASP90	870-890	550.00	660.00	550.00	660.00
1000	ASP10	970-990	714.17	857.00	714.17	857.00
1200	ASP12	1170-1190	733.33	880.00	733.33	880.00

Door is reversible.



Hinge Door in Recess - Shown in Brushed Brass

Handles



Chrome
Solid metal handle with a chrome finish.

Colour Handles
Double metal handle with colour finish.

Technical Drawing

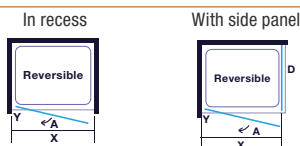

Colour Finishes; Express Yourself

When ordering your door please use the correct code to the size required. Then add the colour code you need.

Example: AH76 is the standard chrome code add **MB** for Matt Black, **BBR** for Brushed Brass, **BN** for Brushed Nickel or **BGM** for Brushed Gun Metal.

Example: AH76 + MB (Matt Black) = AH76MB.
Chrome option is your standard code.



Extension profiles available. See Page 123



NEW!

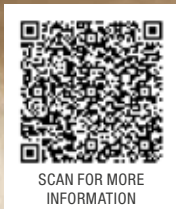

SCAN FOR MORE INFORMATION

Hinge Door with Side Panel shown as Left Hand (L) - Shown in Brushed Gun Metal



TRUESTONE®

Match our ARYSTO SLEEK enclosures with our Truestone trays for that all inspiring look and feel.



HINGE DOOR AND INLINE PANEL

Our fully reversible hinge door also comes with an inline and side panel option for larger spaces. The ultra-slim profile is complimented by slim hinges with concealed fixings for a sleek finish that is easier to clean and maintain.

Brushed Nickel and Brushed Gun Metal are available on the next page.

HINGE DOOR & INLINE PANEL IN MATT BLACK, BRUSHED BRASS & CHROME

Size	Code	Adjustment in Recess Min-Max	Adjustment with Side Panel Min-Max	Door Opening X	Door Swing Y	Fixed Panel B	Chrome Pricing		Matt Black Pricing (MB)		Brushed Brass Pricing (BBR)	
							Price £ Exc. VAT	Price £ Inc. VAT	Price £ Exc. VAT	Price £ Inc. VAT	Price £ Exc. VAT	Price £ Inc. VAT
1200	AHI12	1150-1190	1153-1193	600	630	495	1100.83	1321.00	1211.67	1454.00	1349.17	1619.00
1400	AHI14	1350-1390	1353-1393	700	730	595	1321.67	1586.00	1450.83	1741.00	1652.50	1983.00

Door is reversible.

SIDE PANEL IN MATT BLACK, BRUSHED BRASS & CHROME

Size	Code	Adjustment Min-Max	Chrome Pricing		Matt Black Pricing (MB)		Brushed Brass Pricing (BBR)	
			Price £ Exc. VAT	Price £ Inc. VAT	Price £ Exc. VAT	Price £ Inc. VAT	Price £ Exc. VAT	Price £ Inc. VAT
760	ASP76	730-750	408.33	490.00	455.83	547.00	517.50	621.00
800	ASP80	770-790	412.50	495.00	460.00	552.00	524.17	629.00
900	ASP90	870-890	440.00	528.00	482.50	579.00	550.00	660.00
1000	ASP10	970-990	555.00	666.00	628.33	754.00	714.17	857.00
1200	ASP12	1170-1190	560.83	673.00	650.00	780.00	734.17	881.00

Door is reversible.



Hinge & Inline Door in Recess - Shown in Chrome

Handles



Chrome
Solid metal handle with a chrome finish.

Colour Handles
Double metal handle with colour finish.

Technical Drawing

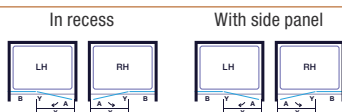

Colour Finishes; Express Yourself

When ordering your door please use the correct code to the size required. Then add the colour code you need.

Example: AHI12 is the standard chrome code add **MB** for Matt Black, **BBR** for Brushed Brass, **BN** for Brushed Nickel or **BGM** for Brushed Gun Metal.

Example: AHI12 + MB (Matt Black) = AHI12MB.
Chrome option is your standard code.



Extension profiles available. See Page 123



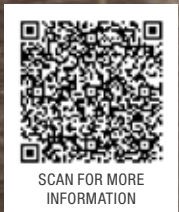

SCAN FOR MORE INFORMATION

Hinged Door & Inline Panel shown as Right Hand (R) - Shown in Brushed Brass



 TRUESTONE®

Match our ARYSTO SLEEK enclosures with our Truestone trays for that all inspiring look and feel.



HINGE DOOR AND INLINE PANEL - NEW COLOURS

Our fully reversible hinge door also comes with an inline and side panel option for larger spaces. The ultra-slim profile is complimented by slim hinges with concealed fixings for a sleek finish that is easier to clean and maintain.

HINGE DOOR & INLINE PANEL IN BRUSHED NICKEL & BRUSHED GUN METAL

Size	Code	Adjustment in Recess Min-Max	Adjustment with Side Panel Min-Max	Door Opening X	Door Swing Y	Fixed Panel B	Brushed Nickel Pricing (BN)		Brushed Gun Metal Pricing (BGM)	
							Price £ Exc. VAT	Price £ Inc. VAT	Price £ Exc. VAT	Price £ Inc. VAT
1200	AHI12	1150-1190	1153-1193	600	630	495	1349.17	1619.00	1349.17	1619.00
1400	AHI14	1350-1390	1353-1393	700	730	595	1652.50	1983.00	1652.50	1983.00

Door is reversible.

SIDE PANEL IN BRUSHED NICKEL & BRUSHED GUN METAL

Size	Code	Adjustment Min-Max	Brushed Nickel Pricing (BN)		Brushed Gun Metal Pricing (BGM)	
			Price £ Exc. VAT	Price £ Inc. VAT	Price £ Exc. VAT	Price £ Inc. VAT
760	ASP76	730-750	517.50	621.00	517.50	621.00
800	ASP80	770-790	524.17	629.00	524.17	629.00
900	ASP90	870-890	550.00	660.00	550.00	660.00
1000	ASP10	970-990	714.17	857.00	714.17	857.00
1200	ASP12	1170-1190	733.33	880.00	733.33	880.00

Door is reversible.



Hinge & Inline Door in Recess - Shown in Chrome

Handles



Chrome
Solid metal handle with a chrome finish.

Colour Handles
Double metal handle with colour finish.

Technical Drawing

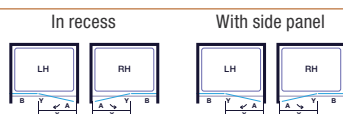

Colour Finishes; Express Yourself

When ordering your door please use the correct code to the size required. Then add the colour code you need.

Example: AHI12 is the standard chrome code add **MB** for Matt Black, **BBR** for Brushed Brass, **BN** for Brushed Nickel or **BGM** for Brushed Gun Metal.

Example: AHI12 + MB (Matt Black) = AHI12MB.
Chrome option is your standard code.



Extension profiles available. See Page 123



NEW!

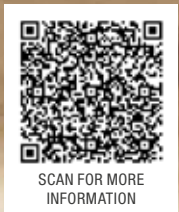

Hinged Door & Inline Panel shown as Left Hand (L) - Shown in Brushed Gun Metal



TRUESTONE®

Match our ARYSTO SLEEK enclosures with our Truestone trays for that all inspiring look and feel.



BIFOLD DOOR

The Arysto Sleek Bifold door optimises space by folding easily into two sections, pulling open and sliding to one side in a single, smooth motion. Ideal for tight spaces with a minimal footprint.

Our Bifold door comes fully assembled. Brushed Nickel and Brushed Gun Metal are available on the next page.

BIFOLD DOOR IN MATT BLACK, BRUSHED BRASS & CHROME

Size	Code	Adjustment in Recess	Adjustment with Side Panel	Door Opening X	Moving Panel A	Inside Door Swing Z	Chrome Pricing		Matt Black Pricing (MB)		Brushed Brass Pricing (BBR)	
							Price £ Exc. VAT	Price £ Inc. VAT	Price £ Exc. VAT	Price £ Inc. VAT	Price £ Exc. VAT	Price £ Inc. VAT
760	AB76	710-750	713-753	470	306	350	694.17	833.00	758.33	910.00	855.83	1027.00
800	AB80	750-790	753-793	510	326	370	688.33	826.00	764.17	917.00	863.33	1036.00
900	AB90	850-890	853-893	610	376	420	752.50	903.00	828.33	994.00	936.67	1124.00
1000	AB10	950-990	953-993	710	426	475	825.83	991.00	909.17	1091.00	1026.67	1232.00

Door is reversible.

SIDE PANEL IN MATT BLACK, BRUSHED BRASS & CHROME

Size	Code	Adjustment Min-Max	Chrome Pricing		Matt Black Pricing (MB)		Brushed Brass Pricing (BBR)	
			Price £ Exc. VAT	Price £ Inc. VAT	Price £ Exc. VAT	Price £ Inc. VAT	Price £ Exc. VAT	Price £ Inc. VAT
760	ASP76	730-750	408.33	490.00	455.83	547.00	517.50	621.00
800	ASP80	770-790	412.50	495.00	460.00	552.00	524.17	629.00
900	ASP90	870-890	440.00	528.00	482.50	579.00	550.00	660.00
1000	ASP10	970-990	555.00	666.00	628.33	754.00	714.17	857.00
1200	ASP12	1170-1190	560.83	673.00	650.00	780.00	734.17	881.00

Door is reversible.



Bifold Door with Side Panel - Shown in Brushed Brass



Close up of Opening

Handle



Chrome
Solid metal handle with a chrome finish.

Colour Handles
Double metal handle with colour finish.

Technical Drawing

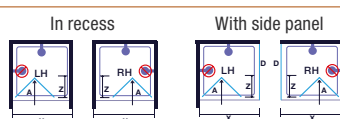

Colour Finishes; Express Yourself

When ordering your door please use the correct code to the size required. Then add the colour code you need.

Example: AB76 is the standard chrome code add **MB** for Matt Black, **BBR** for Brushed Brass, **BN** for Brushed Nickel or **BGM** for Brushed Gun Metal.

Example: AB76 + MB (Matt Black) = AH76MB.
Chrome option is your standard code.



Extension profiles available. See Page 123

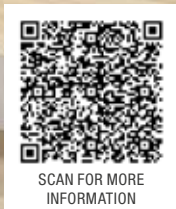

SCAN FOR MORE INFORMATION

Bifold Door in Recess shown as Left Hand (L) - Shown in Matt Black



 TRUESTONE®

Match our ARYSTO SLEEK enclosures with our Truestone trays for that all inspiring look and feel.



BIFOLD DOOR - NEW COLOURS

The Arysto Sleek Bifold door optimises space by folding easily into two sections, pulling open and sliding to one side in a single, smooth motion. Ideal for tight spaces with a minimal footprint.

Our Bifold door comes fully assembled.

BIFOLD DOOR IN BRUSHED NICKEL & BRUSHED GUN METAL

Size	Code	Adjustment in Recess	Adjustment with Side Panel	Door Opening X	Moving Panel A	Inside Door Swing Z	Brushed Nickel Pricing (BN)		Brushed Gun Metal Pricing (BGM)	
							Price £ Exc. VAT	Price £ Inc. VAT	Price £ Exc. VAT	Price £ Inc. VAT
760	AB76	710-750	713-753	470	306	350	855.83	1027.00	855.83	1027.00
800	AB80	750-790	753-793	510	326	370	862.50	1035.00	862.50	1035.00
900	AB90	850-890	853-893	610	376	420	935.83	1123.00	935.83	1123.00
1000	AB10	950-990	953-993	710	426	475	1026.67	1232.00	1026.67	1232.00

Door is reversible.

SIDE PANEL IN BRUSHED NICKEL & BRUSHED GUN METAL

Size	Code	Adjustment Min-Max	Brushed Nickel Pricing (BN)		Brushed Gun Metal Pricing (BGM)	
			Price £ Exc. VAT	Price £ Inc. VAT	Price £ Exc. VAT	Price £ Inc. VAT
760	ASP76	730-750	517.50	621.00	517.50	621.00
800	ASP80	770-790	524.17	629.00	524.17	629.00
900	ASP90	870-890	550.00	660.00	550.00	660.00
1000	ASP10	970-990	714.17	857.00	714.17	857.00
1200	ASP12	1170-1190	733.33	880.00	733.33	880.00

Door is reversible.



Bifold Door with Side Panel - Shown in Brushed Brass



Close up of Opening

Handle



Chrome
Solid metal handle with a chrome finish.

Colour Handles
Double metal handle with colour finish.

Technical Drawing

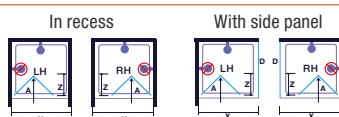

Colour Finishes; Express Yourself

When ordering your door please use the correct code to the size required. Then add the colour code you need.

Example: AB76 is the standard chrome code add **MB** for Matt Black, **BBR** for Brushed Brass, **BN** for Brushed Nickel or **BGM** for Brushed Gun Metal.

Example: AB76 + MB (Matt Black) = AH76MB.
Chrome option is your standard code.



Extension profiles available. See Page 123



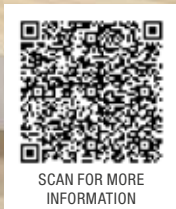

SCAN FOR MORE INFORMATION

Bifold Door in Recess shown as Left Hand (L) - Shown in Matt Black



 TRUESTONE®

Match our ARYSTO SLEEK enclosures with our Truestone trays for that all inspiring look and feel.



FRAMED WETROOM PANELS

The Arysto Sleek Wetroom shower screen can be used to create a seamless, walk-in shower enclosure. Suitable for use with or without a shower tray, the minimalist frame with a 1m support bar is perfect for contemporary and traditional bathroom designs. **Available in Brushed Brass, Brushed Bronze and Matt Black.**

FRAMED WETROOM PANELS IN MATT BLACK, BRUSHED BRASS & BRUSHED BRONZE

Size	Code	Adjustment in Recess Min-Max	Brushed Brass Pricing (BBR)		Brushed Bronze Pricing (BBZ)		Matt Black Pricing (MB)	
			Price £ Exc. VAT	Price £ Inc. VAT	Price £ Exc. VAT	Price £ Inc. VAT	Price £ Exc. VAT	Price £ Inc. VAT
800	AW80 add BBZ, MB or BBR	775-790	706.67	848.00	706.67	848.00	706.67	848.00
900	AW90 add BBZ, MB or BBR	875-890	725.00	870.00	725.00	870.00	725.00	870.00
1000	AW10 add BBZ, MB or BBR	975-990	743.33	892.00	743.33	892.00	743.33	892.00
1200	AW12 add BBZ, MB or BBR	1175-1190	766.67	920.00	766.67	920.00	766.67	920.00

Wetroom Panel is reversible. Available in Brushed Brass, Matt Black and Brushed Bronze only (Not available in Chrome). Comes with a 1m bracing bar. Sizes 800mm and 900mm comes with a T-bracket as standard.

VERTICAL CEILING SUPPORT BAR

Size	Code	Brushed Brass Pricing (BBR)		Brushed Bronze Pricing (BBZ)		Matt Black Pricing (MB)	
		Price £ Exc. VAT	Price £ Inc. VAT	Price £ Exc. VAT	Price £ Inc. VAT	Price £ Exc. VAT	Price £ Inc. VAT
400	B0040 add BBZ, MB or BBR	146.67	176.00	146.67	176.00	146.67	176.00

1.5M OPTIONAL SUPPORT BAR

Size	Code	Brushed Brass Pricing (BBR)		Brushed Bronze Pricing (BBZ)		Matt Black Pricing (MB)	
		Price £ Exc. VAT	Price £ Inc. VAT	Price £ Exc. VAT	Price £ Inc. VAT	Price £ Exc. VAT	Price £ Inc. VAT
1.5M	B0029 add BBZ, MB or BBR	101.67	122.00	101.67	122.00	101.67	122.00



Framed Wetroom Panel shown in Matt Black (MB)



Close up of Support Bar

Colour Finishes; Express Yourself

When ordering your door please use the correct code to the size required. Then add the colour code you need.

Example: AW80 is the standard chrome code add **MB** for Matt Black, **BBR** for Brushed Brass, or **BBZ** for Brushed Bronze

Example: AW80+ MB (Matt Black) = AW80MB.

Chrome option is your standard code.



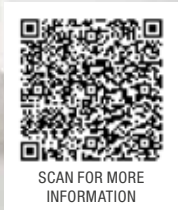

SCAN FOR MORE
INFORMATION

Framed Wetroom Panel shown in Brushed Brass (BBR)



 TRUESTONE®

Match our ARYSTO SLEEK
enclosures with our Truestone trays
for that all inspiring look and feel.

THE BATH SCREEN COLLECTION

Shaped and contoured for space and elegance, the MERLYN Bath Screen Collection is the perfect solution for in-bath showering. Innovative design and contemporary aesthetics bring this bathroom favourite to life with modern shapes and features to enjoy for years to come.

Colour Finishes; *Express Yourself*

When ordering your door please use the correct code to the size required. Then add the colour code you need.

Example: GMBS1 is the standard chrome code add **MB** for Matt Black, **BBR** for Brushed Brass, **BBZ** for Brushed Bronze or **BSS** for Brushed Stainless Steel.

Example: GMBS1+ MB (Matt Black) = GMBS1-MB.

Chrome option is your standard code.

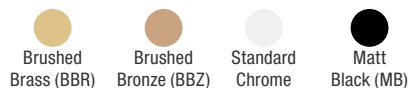



SINGLE HINGED - COLOUR

Features

- » 10mm toughened glass.
- » PVD is one of the most durable and luxurious finishes available ensuring it will last the test of time.
- » Four colour finishes.
- » Wetroom compatible.



Brushed Brass

DOUBLE PANEL - COLOUR

Features

- » 10mm toughened glass.
- » PVD is one of the most durable and luxurious finishes available ensuring it will last the test of time.
- » Four colour finishes.
- » Wetroom compatible.



Brushed stainless Steel

SINGLE HINGED BATH SCREEN

Size	Code	Moving Panel A	Chrome Pricing		Colour Pricing (Longer Lead Time)	
			Price £ Exc. VAT	Price £ Inc. VAT	Price £ Exc. VAT	Price £ Inc. VAT
875 x 1500	GMBS1	850	745.83	895.00	997.50	1197.00

Technical drawing

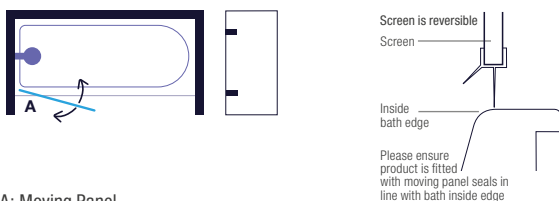

A: Moving Panel

☉ Recommended shower head position

Please Note: All wall hinges must be secured to a reinforced stud or solid block wall. Please ensure product is fitted with moving panel seals in line with bath inside edge.

DOUBLE PANEL BATH SCREEN

Size	Code	Moving Panel A	Fixed Panel B	Chrome Pricing		Colour Pricing (Longer Lead Time)	
				Price £ Exc. VAT	Price £ Inc. VAT	Price £ Exc. VAT	Price £ Inc. VAT
1075 x 1500	GMBS2	750	300	818.33	982.00	1095.00	1314.00

Technical drawing

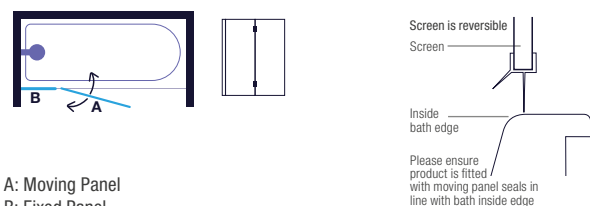

A: Moving Panel
B: Fixed Panel

☉ Recommended shower head position

Please ensure product is fitted with moving panel seals in line with bath inside edge. Please Note: All wall hinges must be secured to a reinforced stud or solid block wall.



Brushed Brass

MB14 Bathscreen

MERLYN FIXED SINGLE SQUARE - COLOUR

Size	Code	Colour Code	Panel	Product Adjustment	Price £ Exc. VAT	Price £ Inc. VAT
800 x 1500	MB14	Chrome only code	1	785-800	266.67	320.00
800 x 1500	MB14	add MB / BBR or BBZ	1	785-800	273.33	328.00

Features

- » Anodised aluminium finish - more durable than powder coating.
- » Reversible.
- » Four colour finishes. Matt Black, Brushed Brass, Chrome and Brushed Bronze.
- » Minimalist frameless design.

Technical drawing

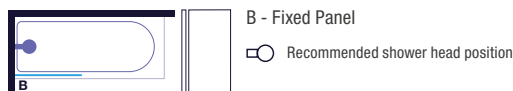

Brushed Bronze

MB14F Bathscreen

MERLYN FIXED FRAMED - COLOUR

Size	Code	Colour Code	Panel	Product Adjustment	Price £ Exc. VAT	Price £ Inc. VAT
800 x 1500	MB14F	add MB / BBR or BBZ	1	775-790	375.83	451.00

Not available in chrome

Features

- » Anodised aluminium finish - more durable than powder coating.
- » Reversible.
- » Fully framed design.
- » Three colour finishes. Matt Black, Brushed Brass and Brushed Bronze.

Technical drawing

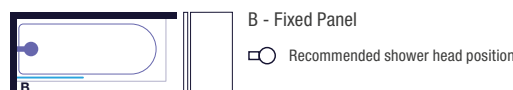

Matt Black

MERLYN BLACK HINGED 2 PANEL - LEFT HAND AND RIGHT HAND

Size	Code	Panel	Product Adjustment	Price £ Exc. VAT	Price £ Inc. VAT
900 x 1500	BLKMB7L	2	880-890	743.33	892.00
900 x 1500	BLKMB7R	2	880-890	743.33	892.00

Features

- » Available in Chrome & Matt Black
- » Anodised aluminium matte black finish - more durable than powder coating
- » This product is handed

Technical drawing

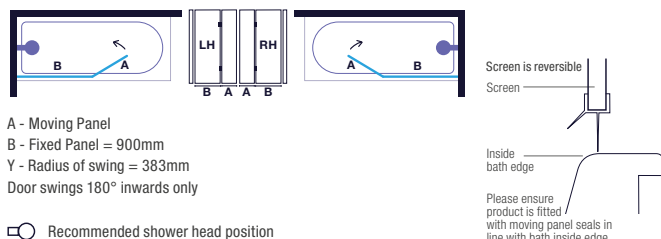



MB6
Bathscreen

1500
MM
HEIGHT
STANDARD RANGE

8
MM
GLASS
THICKNESS

MERSHIELD
STAYCLEAR



SCAN FOR MORE
INFORMATION

HINGED SQUARE

Size	Code	Panel	Product Adjustment	Price £ Exc. VAT	Price £ Inc. VAT
850 x 1500	MB6	1	850 - 870	609.17	731.00

Technical drawing

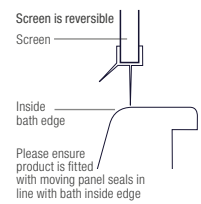
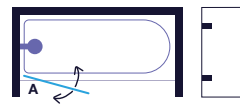

A: Moving Panel

○ Recommended shower head position



MB7
Bathscreen

1500
MM
HEIGHT
STANDARD RANGE

8
MM
GLASS
THICKNESS

MERSHIELD
STAYCLEAR



SCAN FOR MORE
INFORMATION

2 PANEL HINGED - LEFT HAND AND RIGHT HAND

Size	Code	Panel	Product Adjustment	Price £ Exc. VAT	Price £ Inc. VAT
900 x 1500	MB7L Left Handed	2	880 - 900	735.83	883.00
900 x 1500	MB7R Right Handed	2	880 - 900	735.83	883.00

Technical drawing

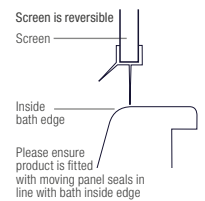

A - Moving Panel

B - Fixed Panel = 500mm

Y - Radius of swing = 383mm

Door swings 180° inwards only

○ Recommended shower head position



MB8
Bathscreen

1500
MM
HEIGHT
STANDARD RANGE

8
MM
GLASS
THICKNESS

MERSHIELD
STAYCLEAR



SCAN FOR MORE
INFORMATION

2 PANEL FOLDING

Size	Code	Panel	Product Adjustment	Price £ Exc. VAT	Price £ Inc. VAT
1100 x 1500	MB8	2	1080 - 1100	739.17	887.00

Technical drawing

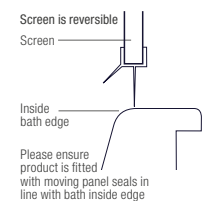
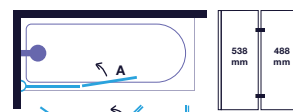

A - Moving Panel

B - Fixed Panel

Y - Radius of swing = 570mm

Door swings 90° inwards and outwards

○ Recommended shower head position



3 PANEL FOLDING					
Size	Code	Panel	Product Adjustment	Price £ Exc. VAT	Price £ Inc. VAT
1400 x 1500	MB9	3	1380 - 1400	932.50	1119.00

Technical drawing

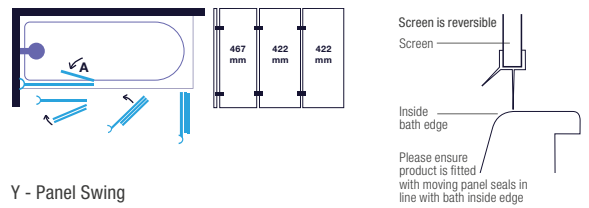

Y - Panel Swing
Screen swing 90° inwards & outwards

☉ Recommended shower head position



SINGLE SQUARE					
Size	Code	Panel	Product Adjustment	Price £ Exc. VAT	Price £ Inc. VAT
800 x 1500	MB10	1	780 - 800	602.50	723.00

Technical drawing



A - Moving Panel
Y - Radius of swing = 740mm
Door swings 90° inwards and outwards

☉ Recommended shower head position



SINGLE CURVED					
Size	Code	Panel	Product Adjustment	Price £ Exc. VAT	Price £ Inc. VAT
800 x 1500	MB11	1	780 - 800	542.50	651.00

Technical drawing



A - Moving Panel
Y - Radius of swing = 740mm
Door swings 90° inwards and outwards

☉ Recommended shower head position

MERLYN

trays

Beautifully sculpted shower trays, angled and contoured to match all enclosures and spaces, achieving the perfect combination of luxury, elegance and durability.





Truestone Black Shower Tray

LUXURIOUS TEXTURED SLATE TRAYS

Beautifully handcrafted and ultra-low slate trays, elegant in appearance and luxurious to touch. With 5 finishes to choose from - Black, Sandstone, Graphite, White, and Fossil Grey.

These trays will bring an element of natural beauty and a truly designer finish to your bathroom.



Features

- » Ultra Slim: only 30mm in height.
- » Handcrafted from high grade stone resin.
- » 5 Colour Options - Black, Sandstone, Graphite, White and Fossil Grey
- » Integrated Discreet Waste.
- » Luxurious Textured Finish.
- » Can be fitted on or level with floor.
- » Comes with 90mm Fast Flow Waste.
- » Our self cleaning vortex waste design: Offers a maintenance free solution as it doesn't require any cleaning.
- » Our Truestone trays can be cut to size, (amount that can be cut, to be agreed by Merlyn) without affecting the guarantee.
- » Please Note: Images are for illustrative purposes only. The colours & finishes shown in the catalogue are as accurate as possible within the limits of the printing process.



MERLYN Branded Waste Cover

Please ensure that the shower head is not positioned directly over the waste as this may restrict flow rate.



CHOOSE YOUR COLOUR



White
Code W



Fossil Grey
Code F

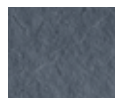

Graphite
Code G



Black
Code B



Sandstone
Code S

All tray codes need the corresponding colour code at the end. (See below) e.g. T108RTW

RECTANGULAR TRAY (COMES WITH MERLYN 90MM FAST FLOW WASTE)

Size	Code	Price £ Exc. VAT	Price £ Inc. VAT
1000 x 800	T108RT	465.83	559.00
1200 x 800	T128RT	551.67	662.00
1200 x 900	T129RT	619.17	743.00
1400 x 800	T148RT	613.33	736.00
1400 x 900	T149RT	674.17	809.00
1500 x 800	T158RT	648.33	778.00
1500 x 900	T159RT	825.00	990.00
1600 x 800	T168RT	692.50	831.00
1600 x 900	T169RT	894.17	1073.00
1700 x 800	T178RT	760.00	912.00
1700 x 900	T179RT	923.33	1108.00

All tray codes need the corresponding colour code at the end.
(See below) e.g. T108RTW

QUADRANT TRAY (COMES WITH MERLYN 90MM FAST FLOW WASTE)

Size	Code	Price £ Exc. VAT	Price £ Inc. VAT
900 x 900	T90Q	438.33	526.00

All tray codes need the corresponding colour code at the end.
(See below) e.g. T90QW

OFFSET QUADRANT TRAY (COMES WITH MERLYN 90MM FAST FLOW WASTE)

Size	Code	Price £ Exc. VAT	Price £ Inc. VAT
1000 x 800	T108H (L or R)	575.00	690.00
1200 x 900	T129H (L or R)	674.17	809.00

All tray codes need the corresponding colour code at the end.
(See below) e.g. T108HW

This product is handed – please choose
L for Left and R for Right when ordering.

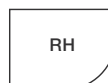

Ultra slim tray 30mm

SQUARE TRAY (COMES WITH MERLYN 90MM FAST FLOW WASTE)

Size	Code	Price £ Exc. VAT	Price £ Inc. VAT
900 x 900	T90RT	490.00	588.00

MERLYN SLIP RESISTANT TRAYS



SLIP RESISTANT TRAYS

We have carried out all the testing to give you and your family the peace of mind of showering in a safe environment with the splendour of this natural stone effect.



EASY CLEAN

All you need is a soft cloth and warm soapy water.



QUALITY LOOK AND FEEL

The luxury satin look and feel is designed to give confidence while not feeling harsh underfoot.

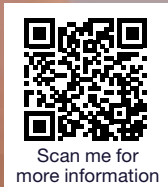

Exceeds Class C for DIN 51097 - Barefoot ramp test.
This ranks MERLYN in a premium class.

LEVEL25^{SR}

The Level25-SR and standard Level25 trays are sleek and ultra slim creating a modern and contemporary feel. At only 25mm high they can be fitted flush to the floor encompassing all the benefits of a wetroom floor and accessibility but without the costly wetroom installation.

Features

- » Ultra slim 25mm low level tray.
- » Sleek minimalist design.
- » Discreet integrated waste cover.
- » Can be fitted on or level with floor.
- » Comes with 90mm fast flow waste.
- » Shower tray 25 year guarantee.
- » The Level25 tray is capped with an easy to clean surface that provides a chemical resistant, anti-bacterial solution due to it's ultra-smooth, non-porous surface.
- » Available in square, rectangular and quadrant trays.
- » Please note: The Level 25 tray must be fitted with the waste positioned along the back wall and not to the front.

SLIP RESISTANT TRAYS

RECTANGULAR & SQUARE TRAYS

Size	Code	Price £ Exc. VAT	Price £ Inc. VAT
900 x 900	L90SQAS	582.50	699.00
1000 x 800	L108RTAS	570.83	685.00
1000 x 900	L109RTAS	635.00	762.00
1100 x 800	L118RTAS	635.00	762.00
1100 x 900	L119RTAS	635.00	762.00
1200 x 700	L127RTAS	635.00	762.00
1200 X 800	L128RTAS	610.83	733.00
1200 x 900	L129RTAS	642.50	771.00
1300 x 800	L138RTAS	945.00	1134.00
1300 x 900	L139RTAS	945.00	1134.00
1400 x 760	L1476RTAS	954.17	1145.00
1400 x 800	L148RTAS	928.33	1114.00
1400 x 900	L149RTAS	928.33	1114.00
1500 x 800	L158RTAS	997.50	1197.00
1500 x 900	L159RTAS	1016.67	1220.00
1600 x 800	L168RTAS	1030.00	1236.00
1600 x 900	L169RTAS	1040.00	1248.00
1700 x 700	L177RTAS	1160.00	1392.00
1700 x 800	L178RTAS	1171.67	1406.00
1700 x 900	L179RTAS	1179.17	1415.00

All trays come with a MERLYN 90mm fast flow waste.

QUADRANT TRAY

Size	Code	Price £ Exc. VAT	Price £ Inc. VAT
900 x 900	L90QAS	661.67	794.00
*1200 x 900	L129QLAS	933.33	1120.00
*1200 x 900	L129QRAS	933.33	1120.00

All trays come with a MERLYN 90mm fast flow waste.

This product is handed – please choose L for Left Hand and R for Right Hand when ordering.



SCAN FOR video



Exceeds Class C for DIN 51097 - Barefoot ramp test.
This ranks MERLYN in a premium class.



Tray Waste



Please ensure that the shower head is not positioned directly over the waste as this may restrict flow rate.

*Quadrant tray is handed – please choose L for Left Hand and R for Right Hand when ordering.

Please note:

The Level 25 tray must be fitted with the waste positioned along the back wall and not to the front. Contact: technical@merlyn.ie for more information.

STANDARD TRAYS

RECTANGULAR & SQUARE TRAYS

Size	Code	Price £ Exc. VAT	Price £ Inc. VAT
900 x 900	L90SQ	401.67	482.00
1000 x 800	L108RT	401.67	482.00
1000 x 900	L109RT	439.17	527.00
1100 x 800	L118RT	439.17	527.00
1100 x 900	L119RT	443.33	532.00
1200 x 760	L1276RT	443.33	532.00
1200 x 700	L127RT	443.33	532.00
1200 x 800	L128RT	447.50	537.00
1200 x 900	L129RT	452.50	543.00
1300 x 800	L138RT	652.50	783.00
1300 x 900	L139RT	665.83	799.00
1400 x 760	L1476RT	671.67	806.00
1400 x 800	L148RT	646.67	776.00
1400 x 900	L149RT	646.67	776.00
1500 x 800	L158RT	703.33	844.00
1500 x 900	L159RT	703.33	844.00
1600 x 800	L168RT	725.00	870.00
1600 x 900	L169RT	732.50	879.00
1700 x 700	L177RT	725.00	870.00
1700 x 760	L1776RT	754.17	905.00
1700 x 800	L178RT	824.17	989.00
1700 x 900	L179RT	838.33	1006.00

All trays come with a MERLYN 90mm fast flow waste.

QUADRANT TRAY

Size	Code	Price £ Exc. VAT	Price £ Inc. VAT
900 x 900	L90Q	465.83	559.00
*1200 x 900	L129QL	657.50	789.00
*1200 x 900	L129QR	657.50	789.00

All trays come with a MERLYN 90mm fast flow waste.

This product is handed – please choose L for Left Hand and R for Right Hand when ordering.



PENTANGLE TRAY



Pentangle Tray

THE STUNNING NEW MERLYN PENTANGLE TRAY IS MADE FROM A NATURAL STONE RESIN WITH A LUXURIOUS MATTE WHITE TEXTURED FINISH.

Size	Code	Price £ Exc. VAT	Price £ Inc. VAT
900 x 900	T90PW	453.33	544.00
1200 x 900	T129PWR	505.83	607.00
1200 x 900	T129PWL	505.83	607.00
1400 x 900	T149PWR	535.83	643.00
1400 x 900	T149PWL	535.83	643.00

This product is handed – please choose L for Left and R for Right when ordering.

Features

- » 40mm in height.
- » Handcrafted from high grade stone resin.
- » Integrated discreet waste.
- » Luxurious matte textured finish.
- » Comes with 90mm fast flow waste.

TOUCHSTONE-SR

Designed in a beautiful matt white finish without the harsh surface texture, sometimes, experienced in a slip resistant finish. Best in class - Exceeding the requirement in two independently tested industry standards.

Features

- » 10 Year Guarantee.
- » Single skinned with moulded solid under section.
- » 50mm high to achieve minimalist design.
- » Antislip is manufactured into the coating and won't wear.
- » 135mm high including tray panel kit.
- » Compatible 90mm fast flow waste also available.

SLIP RESISTANT TRAYS

RECTANGULAR & SQUARE TRAYS

Size	Code	Tray Panel Kit	Price £ Exc. VAT	Price £ Inc. VAT	
800 x 800	S80SQASTO	Kit 4	188.33	226.00	
900 x 900	S90SQASTO	Kit 4	213.33	256.00	
900 x 800	S980RTASTO	Kit 4	272.50	327.00	
1000 x 800	S108RTASTO	Kit 4	280.83	337.00	
1000 x 900	S109RTASTO	Kit 4	291.67	350.00	
1100 x 800	S118RTASTO	Kit 4	291.67	350.00	
1200 x 700	S127RTASTO	Kit 4	291.67	350.00	
1200 x 760	S1276RTASTO	Kit 4	306.67	368.00	
1200 x 800	S128RTASTO	Kit 4	324.17	389.00	
1200 x 900	S129RTASTO	Kit 4	348.33	418.00	
1400 x 700	S147RTASTO	Kit 3	466.67	560.00	
1400 x 800	S148RTASTO	Kit 3	466.67	560.00	
1400 x 900	S149RTASTO	Kit 3	491.67	590.00	
1500 x 760	S1576RTASTO	Kit 3	548.33	658.00	
1500 x 800	S158RTASTO	Kit 3	550.83	661.00	
1500 x 900	S159RTASTO	Kit 3	576.67	692.00	
1600 x 700	S167RTASTO	Kit 3	615.83	739.00	
1600 x 800	S168RTASTO	Kit 3	615.83	739.00	
1600 x 900	S169RTASTO	Kit 3	642.50	771.00	
1685 x 700	S177RTASTO		663.33	796.00	
1700 x 700	S177RTASTON	Kit 3	663.33	796.00	
1700 x 800	S178RTASTO	Kit 3	744.17	893.00	
1700 x 900	S179RTASTO	-	801.67	962.00	
1800 x 700	S187RTASTO	-	848.33	1018.00	NEW!
1800 x 800	S188RTASTO	-	886.67	1064.00	NEW!
1800 x 900	S189RTASTO	-	887.50	1065.00	NEW!

*Waste is centred on 1700x800 & 1700x900 trays.

QUADRANT TRAY

Size	Code	Tray Panel Kit	Price £ Exc. VAT	Price £ Inc. VAT	
800 x 800	S80QASTO	Kit 2	205.00	246.00	
900 x 900	S90QASTO	Kit 2	226.67	272.00	
*1000 x 800	S108QLASTO LH	Kit 1	295.00	354.00	
*1000 x 800	S108QRASTO RH	Kit 1	295.00	354.00	
*1200 x 800	S128QLASTO LH	Kit 1	324.17	389.00	
*1200 x 800	S128QRASTO RH	Kit 1	324.17	389.00	
*1200 x 900	S129QLASTO LH	Kit 1	383.33	460.00	
*1200 x 900	S129QRASTO RH	Kit 1	383.33	460.00	

This product is handed – please choose L for Left Hand and R for Right Hand when ordering.

TRAY PANEL KIT

Tray Panel Kit	Code	Price £ Exc. VAT	Price £ Inc. VAT
Kit 1	DRK1	145.83	175.00
Kit 2	DRK2	145.83	175.00
Kit 3	DRK3	144.17	173.00
Kit 4	DRK4	140.83	169.00



WASTE CAPS

NEW!

Colour	Code	Price £ Exc. VAT	Price £ Inc. VAT
White	DWASCAPWHT	20.83	25.00
Matt Black	DWASCAPMB	28.33	34.00
Brushed Brass	DWASCAPBBR	28.33	34.00
Brushed Bronze	DWASCAPBBZ	28.33	34.00
Brushed Gun Metal	DWASCAPBGM	28.33	34.00
Brushed Nickel	DWASCAPBN	28.33	34.00

Chrome cap comes as standard.

Design details



Graduated adjustable leg and easy-fit tray panel kit.



Adjustable leg system.



Left Handed (L) Right Handed (R)

*Quadrant tray is handed – please choose L for Left Hand and R for Right Hand when ordering.



90mm fast flow waste, includes hair trap and chrome cover.

MSTONE

A highly engineered tray providing rigidity and strength and combined with a relatively low weight. MStone trays are ideal for 'low level' installation. Alternatively, you can raise your tray and in such cases you will need the MStone shower tray panel kit.

Features

- » Double skinned for added rigidity.
- » 50mm high to achieve minimalist design.
- » 130mm high including tray panel set.
- » Comes with 90mm fast flow waste.
- » More than 30 sizes available.
- » The MStone tray is capped with an easy to clean surface that provides a chemical resistant, anti-bacterial solution due to it's ultra-smooth, non-porous surface.
- » Available as low level or with tray panel kits for easy installation.
- » Shower tray lifetime guarantee.

STANDARD TRAYS

RECTANGULAR TRAY (COMES WITH MERLYN 90MM FAST FLOW WASTE)

Size	Code	Tray Panel Kit*	Price £ Exc. VAT	Price £ Inc. VAT
900 x 760	D976RT	Kit 4	298.33	358.00
1000 x 800	D108RT	Kit 4	338.33	406.00
1100 x 760	D1176RT	Kit 4	384.17	461.00
1100 x 800	D118RT	Kit 4	360.00	432.00
1200 x 700	D127RT	Kit 4	355.00	426.00
1200 x 760	D1276RT	Kit 4	365.00	438.00
1200 x 800	D128RT	Kit 4	360.83	433.00
1200 x 900	D129RT	Kit 4	385.00	462.00
1400 x 800	D148RT	Kit 3	535.83	643.00
1400 x 900	D149RT	Kit 3	557.50	669.00
1500 x 700	D157RT	Kit 3	626.67	752.00
1500 x 800	D158RT	Kit 3	610.00	732.00
1500 x 900	D159RT	Kit 3	621.67	746.00
1600 x 800	D168RT	Kit 3	715.83	859.00
1600 x 900	D169RT	Kit 3	730.00	876.00
1685 x 700	D177RT	Kit 3	736.67	884.00
1680 x 760	D1776RT	Kit 3	736.67	884.00
1700 X 700	D177RTN	Kit 3	736.67	884.00
1700 X 760	D1776RTN	Kit 3	736.67	884.00
*1700 x 800	D178RT	Kit 3	850.00	1020.00

TRAY PANEL KIT (INCLUDING LEGS)

DRK3	Kit 3	144.17	173.00
DRK4	Kit 4	140.83	169.00



TRAY PANEL KIT (INCLUDING LEGS)

Code	Tray Panel Kit	Price £ Exc. VAT	Price £ Inc. VAT
DRK1	Kit 1	145.83	175.00

WASTE COMPLETE

DWAS	Kit 1	40.83	49.00
------	-------	-------	-------

WASTE CAPS

Colour	Code	Price £ Exc. VAT	Price £ Inc. VAT
White	DWASCAPWHT	20.83	25.00
Matt Black	DWASCAPMB	28.33	34.00
Brushed Brass	DWASCAPBBR	28.33	34.00
Brushed Bronze	DWASCAPBBZ	28.33	34.00
Brushed Gun Metal	DWASCAPBGM	28.33	34.00
Brushed Nickel	DWASCAPBN	28.33	34.00

Chrome cap comes as standard.



SQUARE TRAY (COMES WITH MERLYN 90MM FAST FLOW WASTE)

Size	Code	Tray Panel Kit*	Price £ Exc. VAT	Price £ Inc. VAT
760	D76SQ	Kit 4	194.17	233.00
800	D80SQ	Kit 4	215.00	258.00
900	D76SQ	Kit 4	300.00	360.00

TRAY PANEL KIT (INCLUDING LEGS)

DRK4	Kit 4	140.83	169.00
------	-------	--------	--------

QUADRANT TRAY (COMES WITH MERLYN 90MM FAST FLOW WASTE)

Size	Code	Tray Panel Kit*	Price £ Exc. VAT	Price £ Inc. VAT
800	D80Q	Kit 2	275.00	330.00
900	D90Q	Kit 2	297.50	357.00
1000	D100Q	Kit 5	394.17	473.00

TRAY PANEL KIT (INCLUDING LEGS)

DRK2	Kit 2	145.83	175.00
DRK5	Kit 5	145.83	175.00

OFFSET QUADRANT TRAY (COMES WITH MERLYN 90MM FAST FLOW WASTE)









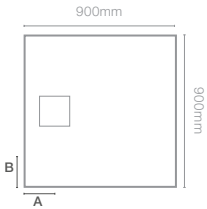



Size	Code	Tray Panel Kit*	Price £ Exc. VAT	Price £ Inc. VAT
900 x 760	D976Q L	Kit 1	413.33	496.00
900 x 760	D976Q R	Kit 1	413.33	496.00
1000 x 800	D108Q L	Kit 1	388.33	466.00
1000 x 800	D108Q R	Kit 1	388.33	466.00
1200 x 800	D128Q L	Kit 1	415.83	499.00
1200 x 800	D128Q R	Kit 1	415.83	499.00
1200 x 900	D129Q L	Kit 1	437.50	525.00
1200 x 900	D129Q R	Kit 1	437.50	525.00

TRAY WASTE

TRUESTONE TRAYS

Shape	Size	Waste Position A, mm	Waste Position B, mm
Square		A	B
	900 x 900	270	450





Rectangle		A	B
	1000 x 800	270	400
	1200 x 800	250	400
	1200 x 900	250	450
	1400 x 800	350	400
	1400 x 900	350	450
	1500 x 800	400	400
	1500 x 900	400	450
	1600 x 800	450	400
	1600 x 900	450	450
	1600 x 900	450	450
	1700 x 800	500	400
	1700 x 900	500	450

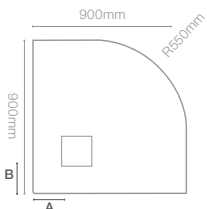

Quad	Size	A	B
	900 x 900	270	270





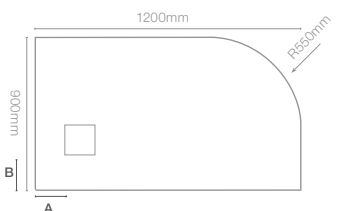





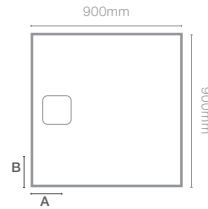











Offset Quad		A	B
	1000 x 800	270	270
	1200 x 900	270	270



LEVEL25 & LEVEL25 SR TRAYS

Shape	Size	Waste Position A, mm	Waste Position B, mm
Square		A	B
	900 x 900	121.5	450



Rectangle		A	B
	1000 x 800	121.5	500
	1000 x 900	121.5	500
	1100 x 800	121.5	550
	1100 x 900	121.5	550
	1200 x 700	121.5	550
	1200 x 760	121.5	600
	1200 x 800	121.5	600
	1200 x 900	121.5	600
	1300 x 800	121.5	650
	1300 x 900	121.5	650
	1400 x 760	121.5	700
	1400 x 800	121.5	700
	1400 x 900	121.5	700
	1500 x 800	121.5	750
	1500 x 900	121.5	750
	1600 x 800	121.5	800
	1600 x 900	121.5	800
	1700 x 760	121.5	850
	1700 x 800	121.5	850
	1700 x 900	121.5	850



Quad	Size	A	B
	900 x 900	121.5	450

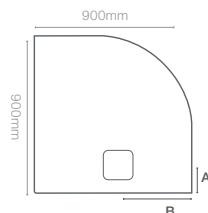

Offset Quad		A	B
	1200 x 900	121.5	600

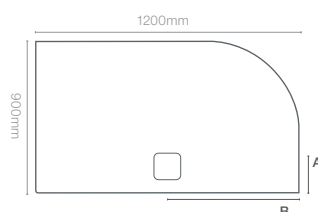

Pentangle Tray

Pentangle Tray

Size	Waste Position (A)	Waste Position (B)
900 x 900	200	250
1200 x 900	200	250
1400 x 900	200	250

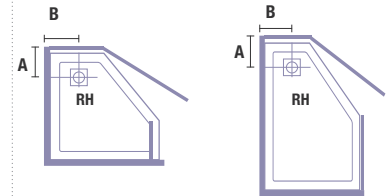

TRAY WASTE

TOUCHSTONE TRAYS

Shape	Size	Waste Position A, mm	Waste Position B, mm
Square		A	B
	760	148	148
	800	148	148
	900	148	148

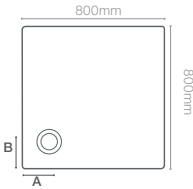

Rectangle	A	B
	800 x 700	148 148
	800 x 760	148 148
	900 x 700	148 148
	900 x 760	148 148
	900 x 800	148 148
	1000 x 700	148 148
	1000 x 760	148 148
	1000 x 800	148 148
	1000 x 900	148 148
	1100 x 760	148 148
	1100 x 800	148 148
	1100 x 900	148 148
	1200 x 700	148 148
	1200 x 760	148 148
	1200 x 800	148 148
	1200 x 900	148 148
	1300 x 800	148 148
	1300 x 900	148 148
	1400 x 700	148 148
	1400 x 760	148 148
	1400 x 800	148 148
	1400 x 900	148 148
	1500 x 700	148 148
	1500 x 760	148 148
	1500 x 800	148 148
	1500 x 900	148 148
	1600 x 700	148 148
	1600 x 760	148 148
	1600 x 800	148 148
	1600 x 900	148 148
	1685 x 700	148 148
	1680 x 760	148 148
	1600 x 900	148 148
	1685 x 700	148 148
	1700 x 800	130 850
	1700 x 900	130 850
	1800 x 700	148 148
	1800 x 760	130 900
	1800 x 800	130 900
	1800 x 900	148 148

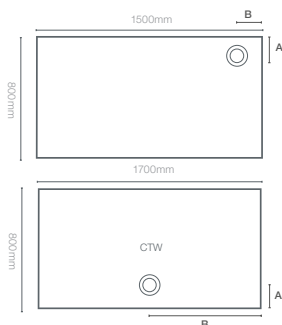

Waste is centred for 1700 x 800 / 1700 x 900 & 1800 x 800 trays

TOUCHSTONE TRAYS - CONTINUED

Shape	Size	Waste Position A, mm	Waste Position B, mm
Quad		A	B
	800	250	130
	900	350	130

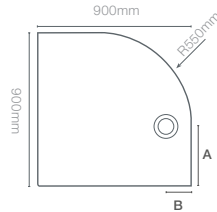

Offset Quad	A	B
	1000 x 800	350 130
	1200 x 800	450 130
	1200 x 900	450 130

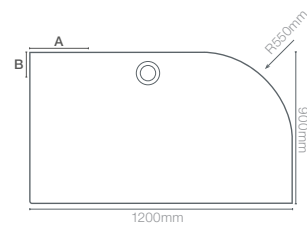

Left Handed (L) Right Handed (R)



Product is handed. Please choose L for Left or R for Right when ordering

MSTONE TRAYS - CONTINUED

Shape	Size	Waste Position A, mm	Waste Position B, mm
Quad		A	B
	800	250	130
	900	350	130
	1000	350	130

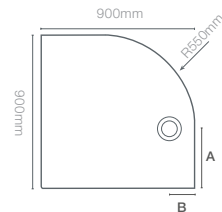

Offset Quad	A	B
	900 X 760	250 130
	1000 X 800	350 130
	1200 X 800	450 130
	1200 X 900	450 130

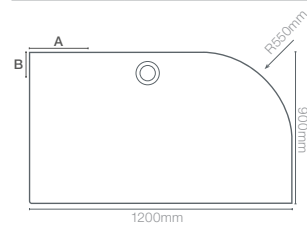

Left Handed (L) Right Handed (R)



Product is handed. Please choose L for Left or R for Right when ordering

MSTONE TRAYS

Shape	Size	Waste Position A, mm	Waste Position B, mm
Square		A	B
	760	148	148
	800	148	148
	900	148	148

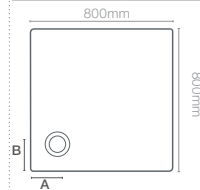

Rectangle	A	B
	900 x 760	148 148
	1000 x 800	148 148
	1100 x 760	148 148
	1100 x 800	148 148
	1200 x 700	148 148
	1200 x 760	148 148
	1200 x 800	148 148
	1200 x 900	148 148
	1400 x 800	148 148
	1400 x 900	148 148
	1500 x 700	148 148
	1500 x 800	148 148
	1500 x 900	148 148
	1600 x 800	148 148
	1600 x 900	148 148
	1685 x 700	148 148
	1680 x 760	148 148
	1700 x 760	148 148
	1700 x 800	850 130

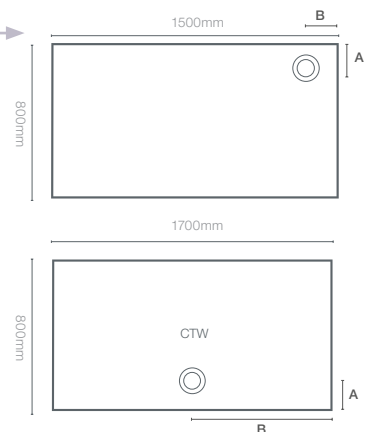

Waste is centred for 1700 x 760 & 1700 x 800 trays

EXTENSION PROFILES

DIAGRAM	SECTION	PRODUCT NAME	CODE	PRICE £ EXC. VAT	PRICE £ INC. VAT
A	ARYSTO 8	Sliding Door	AR8SEXT	94.17	113.00
B	ARYSTO 8	Infold Door	AR8NFEXT1	94.17	113.00
C	ARYSTO 8	Infold Side Panel	AR8NFEXT2	94.17	113.00
D	Arysto Sleek Matt Black	Sliding & Quadrant Doors	ASEXTAMB	90.83	109.00
D	Arysto Sleek Matt Black	Hinge & Infold Doors	ASEXTBMB	90.83	109.00
D	Arysto Sleek Brushed Brass	Sliding & Quadrant Doors	ASEXTABBR	96.67	116.00
D	Arysto Sleek Brushed Brass	Hinge & Infold Doors	ASEXTBBBR	96.67	116.00
D	Arysto Sleek Chrome	Bifold, Hinge & Infold Doors	S6EXTB	74.17	89.00
D	Arysto Sleek Chrome	Sliding & Quadrant Doors	S6EXTA	75.00	90.00

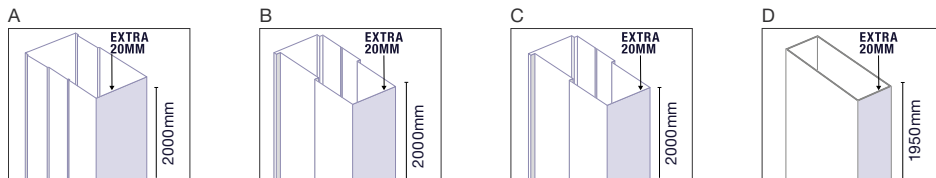

ACCESSORIES

MERLYN WIPER

WIPER ORDER CODE

MG201WIPER 57.50 69.00

As a special gift, we include this complimentary Merlyn Glass Wiper and Holder with each complete ARYSTO TEN product purchased worth just over £50. Comes in a chrome finish only. You can also purchase these for other ranges.



PRODUCT INFORMATION

- » All products are manufactured in accordance with EN 14428 and utilise toughened safety glass to EN 12150. Electrical products comply with all relevant European standards including RoHS, WEEE and IP ratings.
- » All doors feature adjustable wall profiles to compensate for out-of-true walls and have micro adjustment features for fine tuning to obtain a perfect fit and operating action.
- » All wall hinge doors need to be fixed to a solid wall or adequately secure fixing.
- » All standard products are supplied complete with full installation instructions and the necessary fixings.
- » Bespoke sizes cannot be cancelled once order has been processed.
- » Product descriptions do not imply the use of precious or valuable materials.
- » Bath screens are not designed to fit on baths with stepped fronts roll top rims or integral soap dishes.
- » Standard Products - Opened cartons can not be returned. Returns carry a £40 single box charge or £60 per unit where the sale is less than 30 days old. Returns over 30 days old will not be accepted. MERLYN do not accept returns on any bespoke products.
- » ARYSTO TEN by MERLYN is frameless in design. Spray/mist may escape therefore we would recommend use of these enclosures with tiled floors.
- » Water retention is maintained in all products under normal showering conditions. Water jetted, with pressure, directly at joints, seals or openings can naturally force an exit.
- » All enclosures, wetrooms and panels are Power Shower approved – will retain water under normal showering conditions.
- » Only shower enclosures, panels and bath screens are covered by the lifetime guarantee. Please contact the Merlyn sales team for more details.
- » For full details on all product ranges please contact Merlyn.
- » Glass shattering and parts subject to wear are not covered by the lifetime guarantee. Electrical products have a 5 year guarantee and are not covered by the lifetime guarantee.
- » Chrome and Nickel components may differ due to the use of different materials. Please check with your ARYSTO dealer for accurate matching of material samples.
- » Images are for illustrated purposes only. The colours and finishes shown in the catalogue are as accurate as possible within the limits of the printing process. The positioning of all showering heads in the brochure is for illustrative purposes only.
- » Do not direct water directly at the eyelet handle as water will pass through. It is the responsibility of the designer / installer to ensure that the shower head is positioned so this is not an issue.

N.B. We strongly recommend that you use a MERLYN recognised Surveyor and Fitter. CAD or scaled drawings are required especially for sloping panels and panels with dwarf walls. All drawings need to be signed off.

Lifetime Guarantee

At MERLYN research and development is an integral part of the business. All products go through rigorous testing processes so much so that we can confidently stand behind our products and therefore we offer a Lifetime Guarantee covering all manufacturing defects ensuring ultimate peace of mind.

Glass shattering and parts subject to wear are not covered by the lifetime guarantee. Electrical products have a 5 year guarantee and are not covered by the lifetime guarantee.

Please note that the Mershield™ is not covered under the guarantee as it is solely dependent on the owner's water supplier and the level of care and maintenance it receives.

The UKCA (UK Conformity Assessment) mark on MERLYN enclosures is the new standard marking for products on the market in Great Britain (England, Wales and Scotland). It is a declaration that the product complies with GB designated standards.

The CE markings on MERLYN enclosures is a declaration that the product complies with the essential requirements of the relevant European health, safety and environmental protection legislation.

PRODUCT INFORMATION

EU and GB legislation requires manufacturers to display either the UKCA mark for Great Britain and a CE mark for the EU and Northern Ireland on their product or packaging. It is an offence to place a product on the relevant market without a UKCA for Great Britain or CE marking for the EU market.

The manufacturer is legally responsible for ensuring that the product conforms to the requirements of both directives.

The European Commission thus refers to the CE marking as a "Passport" which allows products to be freely circulated within the EU single market. The UKCA marking allows products to move freely within Great Britain.

Often consumers will consider the UKCA and CE markings on a product as an indication of conformance to laid down minimum standards and therefore, a minimum level of safety which other products may lack. Both markings are often seen by consumers as a "Symbol of Safety."



Important

For bespoke sizes please provide overall measurements i.e. tile-to-tile or tile-to-outside edge of tray, all surfaces including trays, walls and floors, all angles and cut-outs etc.

MERLYN accept no responsibility for any incorrect measurements and details provided by customers or retailers. Any order placed to correct the mistake is treated as a new order and will be charged as such. Merlyn do not accept any returns on any bespoke products.

Important Shower Tray Information

Although shower door and enclosure sizes are related to tray sizes it is important to note that most shower trays are tiled down to the rim, often over an "up-stand". The finished installation space may be less than the nominal tray size. ARYSTO shower enclosures are made to suit this remaining space.

The illustrated guide (diagrams on right of page) may be helpful in taking measurements to determine the shower door or enclosure size required. Dimensions given in this publication are in millimetres, are approximate and may vary with adjustment. They are subject to change without notice.

Tray

Ensure strong and secure joints between shower tray and walls, even in the event of floor settlement. Please supply floor plans, photos, site condition details and note anything that might obstruct the product. Special sizes cannot be cancelled once the order has been processed.

Adjustment

This is the min and max adjustment of the actual enclosure. Always ensure the outer most part of the enclosure frame is stepped in far enough from the edge of the tray so that the enclosure frame is sitting on a flat surface and can be sealed correctly. Some trays have larger rounded edges and may need a bigger step in. Ensure that the step in leaves adequate space for the product adjustment.

N.B. Take the measurements after the tray is installed and the walls are tiled.

Disposal and Recycling End of product life

When the product reaches the end of its serviceable life it needs to be disposed of safely and brought to or collected by an approved authorised treatment facility.

Batteries

Used batteries need to be disposed of responsibly and not with your normal household waste. Please contact your local authority for information on recycling and safe disposal.



Measurement Guide

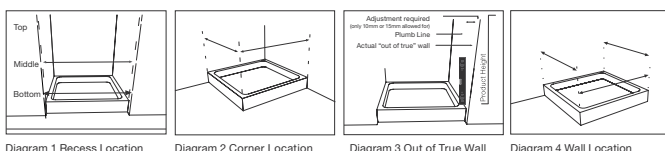

Important Shower Tray Information

- » It is up to the designer or installer to ensure that the tray and enclosure combination is arranged in such a way that water retention meets the customers needs.
- » The waste has the capacity to carry away 27L/Min. High powered systems may exceed this. Please check with the manufacturer.
- » Please ensure that the shower head is not positioned directly over the waste as this may restrict water flow rate.
- » Please ensure that the colour and size of shower tray are as per your order before installation.
- » You must inspect the product thoroughly before installation. Fitting the product is acceptance of quality.
- » The trays are handmade from natural material. Please allow for height variances due to manufacturing tolerances.
- » For open ended shower screens please consult your installer.
- » Shower trays must be fitted as per the fitting instruction. Deviation from the pre installation checks or fitting installation will void the guarantee.
- » When wet, the surface of the majority of shower trays will show an increase in the potential for slipping. This is particularly the case when soap, shampoo, bath oil etc. are used. It is important that designers, installers and users are aware of this.

Cleaning

- » It is important to clean your MERLYN shower door after every use.
- » Wipe down all the glass and metal parts with a soft cloth.
- » Do not allow lime scale to build up in hard water areas.
- » Ensure that any residual water on the glass is removed after every use.
- » Clean the glass regularly using soapy water.
- » Do not use abrasive products on any surfaces.
- » Install the enclosure in a well ventilated area.
- » When cleaning your ARYSTO X do not direct a high pressure stream at the seals or at a point of overlap between 2 panels as some water may escape.

Information and Maintenance

Always read the instructions on the packaging. Chrome is vulnerable to acid attack and some strong household cleaners including strong disinfectants, denture cleaners, hair dyes, wine making chemicals and photographic chemicals may contain acid. These materials may have a varying effect on the surface from black spots/streaks (which cannot be removed) to pitting the surface. Contact with these materials should be avoided.

ISO Certification

MERLYN has implemented an Integrated Management System comprising of Quality Management, Environmental Management and Occupational Health and Safety Management. An Integrated Management System ensures the seamless integration of several different standards into a common system that meets the requirements of each of these standards. These certifications are proof of MERLYN credibility but also to instil confidence in our potential clients that Merlyn will keep its promises.



The ARYSTO collection is available from specialist retail showrooms only. Our dedicated and highly trained MERLYN Sales Team are waiting to provide all the professional assistance and advice needed to help you choose the right enclosure.

Due to our policy of continuous improvement we reserve the right to amend prices, specifications and designs without prior notice.

All material and illustrations included in this catalogue are the copyright of MERLYN Industries Ltd. and cannot be used without prior written permission and credit in any other advertisements, brochures, publication, correspondence, any medium what so ever whether written or electronic including the internet. All prices listed are correct at time of print (July 2025).

All Rights Reserved.

Recycling

Please be aware our cover is non recyclable. Remove cover before recycling the internal pages.

MERLYN™

Unit 8, Purcellsinch Industrial Estate, Dublin Road,
Kilkenny, Ireland, R95 HP71.

T: 0808 1011 429 or E sales@merlyn.ie

www.merlynshowering.com



ARYSTO

