

ROPER RHODES[®]
BATH





THOUGHTFULLY DESIGNED
SINCE 1979

ROPER RHODES®
BATH



CONTENTS

GETTING STARTED



- 06 Our Story
- 08 Our People
- 10 Product standards
- 12 Guide to designing your bathroom
- 14 Space meets style
- 16 Be inspired...
- 18 Meet our collections

PRODUCTS

FURNITURE

- 24 Walcot
- 34 Faber
- 46 Hampton
- 54 Widcombe
- 62 Concierge
- 70 Fairmont
- 78 Scheme
- 90 System
- 100 Academy

CLOAKROOMS

- 106 Hampton
- 108 Esta
- 109 System
- 112 Furniture handles

FITTED FURNITURE

- 116 Discover fitted furniture
- 118 Elan
- 119 Aruba
- 120 Burford

BATHTUBS

- 124 Discover our bathtubs
- 126 Paradigm
- 128 Note
- 132 Contemporary bath accessories
- 133 Harrow
- 134 Widcombe
- 138 Traditional bath accessories

WCs & BASINS

- 142 Discover our WCs & basins
- 144 Faber
- 148 Hampton
- 150 Widcombe
- 152 Harrow
- 154 Elka
- 156 Aruba
- 158 Paradigm
- 160 Countertop basins
- 162 Cisterns & WC frames
- 164 Premium flush plates
- 166 Flushing solutions

TAPS

- 172 Discover our taps
- 176 Elan
- 180 Faber
- 184 Storm-Nova
- 188 Metric
- 190 Clear
- 192 Walcot
- 196 Keswick
- 200 Wessex
- 202 Cranbourne
- 204 Henley
- 206 Wastes & traps

SHOWERS

- 208 Discover our shower systems
- 210 Understanding your shower options
- 212 Concealed push button showers
- 220 Concealed valve showers
- 234 Bar valve showers
- 246 Timeless showers
- 260 Create your own shower system
- 274 Shower seats

ACCESSORIES

- 278 Wall mounted
- 287 Basketware
- 289 Grab bars

LIGHTING

- 292 Discover our lighting
- 296 Globe & Pendant lights
- 298 Traditional lights & down lights
- 299 Strip lights

MIRRORS & CABINETS

- 300 Discover our mirrors
- 306 Loop
- 308 Walcot
- 310 Faber
- 312 Phantom
- 314 Ritual
- 315 Link
- 316 Leap Pro
- 317 Calibre
- 318 Eminence
- 319 Frame
- 320 Thesis
- 321 Traditional, Elle & Hannah
- 322 Discover our cabinets
- 326 Silhouette
- 328 Vault
- 330 Novella
- 331 Notion
- 332 Boost
- 333 Theory
- 334 System
- 335 Medicab

TOILET SEATS & BATH PANELS

- 339 Thermoset toilet seats
- 342 Wooden toilet seats
- 343 Bath panels

All prices are inclusive of VAT at 20%



Great British Heritage

OUR STORY

Appropriately founded in the home of bathing, Roper Rhodes was established in 1979 in the beautiful city of Bath, which we still call our home today. It's been over 40 years since then where we have grown and changed along with the city. Furthermore our passion for design, ingenuity and creativity has never been stronger.

Our products are made with consideration as well as stringently tested to ensure uncompromising performance and durability. Such is the confidence in our designs that our ranges are covered by extensive guarantees for your peace of mind. For example you can relax knowing you will receive a 20 year guarantee against defects in manufacture on sanitaryware and 10 years on our furniture.

We have a rich history but are also obsessed with product development; constantly innovating, with each new product launch seen as an opportunity to improve the lives of our customers. We work on the basis that every aspect of the life of our products must be considered, challenged and designed to be better. This approach has resulted in us having a market leading product innovation vitality score.



Great British Design

OUR PEOPLE

For over forty years, we at Roper Rhodes have striven for bathroom perfection. Our dedicated team has grown from just one man to a group of people obsessed with all the little details that go into making your dream bathroom.

At every step of the way the customer is at the forefront of our minds. Starting with our product designers, who are always in search of how they can improve the bathroom experience. Push-button showers and contactless flushing are just some of the innovations to come from our team of designers.

Once a product has been made, it finds itself within our impressive 200,000 Sq ft Distribution Centre on the outskirts of Bristol. Here we run a twenty-four-hour operation to guarantee you the best delivery and service we can.

We believe that beautiful bathrooms come from our people, who's inspiration and dedication have made Roper Rhodes what it is today.



For a good feeling that lasts ...

PRODUCT STANDARDS

FURNITURE
& FITTED
FURNITURE
PAGES 20-121

We appreciate that when you have made the commitment to invest in such an important room in the house you expect quality and durability. You can rest assured all our products are subject to thorough testing before they ever reach real bathrooms. Please read on to see how every element is assessed.



Our furniture is subject to operational testing including:

- ✓ **HINGES & RUNNERS**
Whether you stow things away to only open up your storage once a week, or you are opening multiple times a day to find your favourite moisturiser you can be sure they will be consistent every time. Components are open/close cycle tested for endurance with **hinges being tested up to 80,000 cycles** and **drawer runners subjected to 50,000 cycles**.
- ✓ **PAINT ADHESION & HARDNESS**
Our furniture is painted to the highest of standards to provide perfect coverage and withstand the rigour of bathroom use, paint adhesion and hardness is tested until failure to ISO standard.

- ✓ **WALL HANGING BRACKETS**
If you have opted for the clean look of a wall hung unit, you can be sure it will withstand the demands of everyday use as our hanging brackets are tested up to **200-260kgs** static load by a hydraulic press.
- ✓ **CORROSION TEST**
Even our knobs and handles are not left to chance. To replicate life in a bathroom these are put through an accelerated corrosion test that produces a corrosive attack to a plated surface to ensure suitability of the coating.



Furniture, Taps,
Mirrors & Cabinets



Ceramics

SANITARYWARE
PAGES 140-169



hush flush™

All Faber WC pans benefit from a whisper quiet flush. Vortex flushing is quieter and uses less water compared to standard rimless pans.

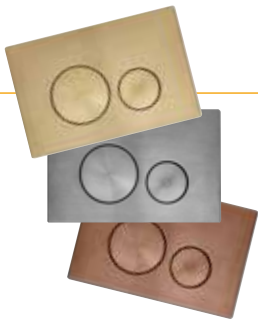

SANITARYWARE

Every piece of our sanitaryware is tested to last for years to come.

- ✓ **FLUSH VOLUME**
The measured discharge on **no occasion should exceed 6L**. Reduced flush shall **not exceed 2/3 of the full flush volume**.
- ✓ **SEAT DROP TEST**
Our seats are tested by **dropping 75kg** from a **height of 30mm 15,000 times**.
- ✓ **MAXIMUM PERFORMANCE**
Tested in accordance with British & European standards meaning our cisterns have passed a **200,000 cycle** endurance test.



BRASSWARE

BRASSWARE
PAGES 170-275

Our tap valves are manufactured in accordance with the relevant product standards including:

- ✓ **PRESSURE TESTED**
Pressure tested to **10bar** in accordance with **BS EN 200: 2008**.
- ✓ **ENDURANCE TESTING**
Cycle testing on handles / valves up to **100,000 cycles**.
- ✓ **CORROSION TEST**
Chrome Plating / Salt spray testing – to ISO standards as stated in **EN 248:2002** plus coating thickness tests on chrome plating.
- ✓ **TEMPERATURE CONTROL**
Temperature stability when the inlet pressure drops (i.e when the cold is turned off) **BS EN 1111 & 1287** to prevent scalding.
- ✓ **WRAS APPROVED**
We also hold several WRAS approvals on our tap ranges, and use WRAS approved components.



MIRRORS & CABINETS

We test every switching interface to **100,000 cycles**, and subject all bonded components to excessive load tests, so even the most chaotic morning in your household can be withstood with ease.

All products are tested to hold a **minimum of 10kg** of extra weight for **10 days** to ensure strength, giving you full confidence that all your storage needs will be met.



MIRRORS,
CABINETS &
LIGHTING
PAGES 290-335

A complete guide to creating your

ROPER RHODES BATHROOM



01 BE INSPIRED

Before beginning your journey, why not check out our Instagram, Pinterest pages or this brochure to be inspired by our stunning roomset designs and layouts.

  @roperrhodes



02

PLAN YOUR SPACE

Consider your bathroom space, which shape and size unit would fit best. For larger spaces our luxurious 1000 and 1200 units will make a spectacular focal point, whilst our 500 and 450 cloakroom styles offer a space saving solution. Our free swatch sample service makes it easy to choose the right finish for your home. Simply fill out the form on our website to order your own.

roperrhodes.co.uk/swatches/



03

PERFECT PAIRING

Once you've chosen your ideal unit size and style, it's time to complete the look with coordinating brassware, sleek storage solutions, intuitive mirrors and beautiful lighting. With endless designs to choose from, you'll be sure to find your perfect match.



04

SPECIALIST ADVICE

Speak to your local Roper Rhodes bathroom specialist for further advice on layouts and design, as well as assistance in ordering and installation. Find your nearest retailer on our website now.

roperrhodes.co.uk/stockists/



05

HERE FOR YOU

Even after you've completed your Roper Rhodes Bathroom, we'll still be here to assist with anything you need.

Product after care, guarantees and access to our customer service team are all available to you, as well as technical support across our website.



For further assistance in planning your bathroom please visit our website to see our Bathroom Renovation Guide roperrhodes.co.uk/bathroom-renovation-guide

Bathroom storage solutions

SPACE MEETS STYLE



CLOAKROOM UNITS

Cloakroom units offer compact, stylish storage solutions that maximize space in smaller bathrooms or guest WCs, keeping essentials organised without compromising on design. For more inspiration, see pages 104-111.



TALL WALL COLUMN

Offers a sleek solution for bulkier items like cleaning products, spare toilet rolls, and oversized bottles - keeping everything organised and within easy reach while maximizing unused space.



*Head of Category - Keith Alcock
Furniture*

MAKE SPACE FOR WHAT MATTERS

'Clever storage solutions for small bathrooms offer endless configurations, whether your style is modern or traditional. From tall pull-out drawers and wall columns to in-drawer organisers, these options create a compact and effortlessly tidy space, making sure that your cloakroom or en suite is free from clutter, becoming a more relaxing space.'



ABOVE WC CABINETS

Add storage without taking up floorspace with an above-the-toilet cabinet. With three shelves and a slim profile, it's ideal for keeping towels and toiletries tidy. See our fitted furniture ranges for more information pages 114-121.



TALL DRAWERS

Tall drawers keeps toiletries, cleaning supplies, and other items neatly hidden, reducing clutter and creating a clean look. Everything has its place, making it easier to access what you need without rummaging through piles of items.

Spotlight on our
INFLUENCERS



@thecottagebythebridge



@_itslucy_

@a.modest.semi

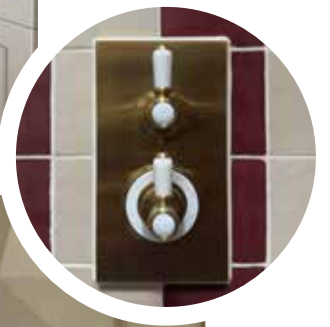

@_myhomeinspo_



@parkplacegower



@thepannellhome



@casaardolino

THE WALCOT COLLECTION

A carefully curated selection of furniture, brassware, mirrors, and accessories that speak to the traditionalist at heart; each element of the Walcot collection has been chosen to reflect refined, elegant, and thoughtful bathroom design.



ELEGANCE FRAMED

Choose from a range of mirrors and accessories that complement the collection's iconic fittings and help create a cohesive, considered design story.

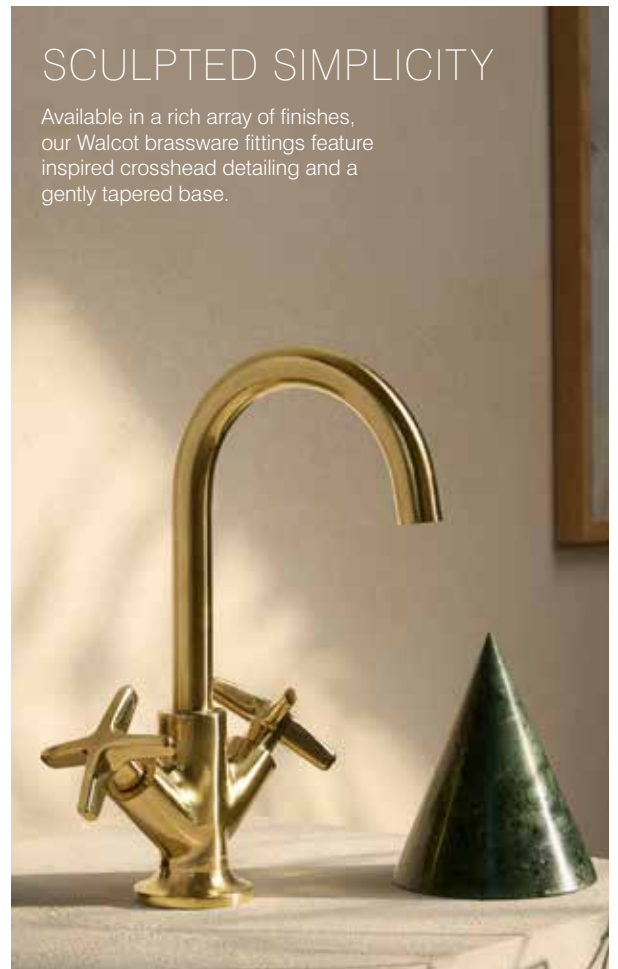

SCULPTED SIMPLICITY

Available in a rich array of finishes, our Walcot brassware fittings feature inspired crosshead detailing and a gently tapered base.

THE FABER COLLECTION

Faber brings a playful yet purposeful approach to bathroom design. With modular furniture options, a wide choice of modern finishes, minimalist mirrors with smart features, and tactile, circular brassware details, Faber invites you to customise your space with creativity and colour.

FUNCTION FIRST DESIGN

Faber sanitaryware includes wall hung, close coupled, and back-to-wall WCs, all featuring a powerful hush flush™ and a rimless, sleek design.



MINIMALIST MIRRORS

An array of smart bathroom mirrors in various shapes and sizes, featuring motion sensors that automatically turn the mirror on as you walk in.

DESIGN MEETS TEXTURE

Faber brassware features dial handles, round plates, and crafted knurled accents for both style and enhanced grip.





FURNITURE



Explore our furniture

COLLECTION

When it comes to adding a stylish yet practical touch to your new bathroom design, choose from the Roper Rhodes furniture collection and you can be assured of hitting the mark.

Our range has something for every taste and the designs incorporate a host of thoughtful features such as useful drawer dividers or internal lighting, soft close drawer runners and door hinges. Handle choices make the furniture truly yours

Discover

ROPER RHODES FURNITURE



FINISHES AND STYLES TO SUIT YOU

Whether you're creating a modern family bathroom or a contemporary cloakroom, we have a range of finishes to meet your needs with our flexible, functional and stunning furniture

All of our furniture ranges benefit from a 10 year guarantee



Contemporary



Mid-Century



Traditional



PAIN T ADHESION & HARDNESS

Our furniture is painted to the highest of standards to provide perfect coverage and withstand the rigour of everyday use, with paint adhesion and hardness tested to ISO standard.

HANDLES THAT DEFINE YOUR STYLE

Our knobs and handles are available in a number of different designs, including brushed brass, nickel, bronze and matt black, so you can match every element in your bathroom.





SMOOTH, SILENT, BUILT TO LAST
 Whether you stow things away to only open up your storage once a week or you are opening multiple times a day to find your favourite moisturiser you can be sure they will be consistent every time. All moving parts are cycle tested to applicable standards - upwards of 50,000 cycles.

SMART STORAGE FOR EVERY SPACE

Our clever storage solutions maximise every inch of space, giving you a clean and clear bathroom without sacrificing practicality.



YOUR PERFECT BASIN & WORKTOP

Designed to suit our extensive range of furniture options, our basins come in ceramic, isocast, countertop and semicountertop varieties to sit perfectly in your bathroom.

WALCOT

Elegant, curated bathroom furniture designed to bring refined style and seamless functionality



Matt white



Walnut veneer



Light oak veneer





Elegant Furniture

WALCOT

10
YEAR

GUARANTEE
for all Walcot
furniture units

From the rich grain of real wood veneer to the quiet glide of soft-close drawers, Walcot furniture is designed to stand up to daily life with ease. Guaranteed for 10 years, our furniture reflects our promise of enduring quality and craftsmanship.

- Available in three veneer wood finishes
- Choose from our choice of handles to make yours unique. See p32 for all handle options
- High quality Hettich soft close runner drawers giving you a smooth, luxurious closing action
- Coordinating Walcot items available to create a cohesive bathroom

Taps p192-195

Showers p236 & p248-p251

Accessories p279

Mirrors p308

Hettich



TOP RIGHT
Bianco marble
worktop chamfer
& tall drawer detail

TOP LEFT
Light oak drawer
detail with Walcot
brushed nickel
handle

BOTTOM
Black marble
worktop detail
with coordinating
Walcot taps





THE WALCOT
COLLECTION IS
DESIGNED TO
BRING HARMONY TO
YOUR BATHROOM,
WITH COORDINATED
ITEMS

Matt White

The matt white finish brings a timeless elegance to bathroom furniture, durable and easy to maintain, the finish not only enhances the visual appeal but also contributes to a fresh, bright atmosphere in the bathroom



Light Oak

Adds a touch of natural warmth and texture to bathroom furniture, creating a welcoming and relaxed atmosphere. With its subtle grain patterns and soft, neutral tone, perfect for a bathroom with a refined and considered style.



Walnut

Walnut brings rich, sophisticated character to bathroom furniture, with its deep tones it adds warmth and luxury to the space. This elegant finish is perfect for creating a bold, refined look, offering a statement of understated elegance and enduring style.



900 3 drawer basin unit
920(w) x 935(h) x 525(d)mm*

1200 4 drawer single basin unit
1220(w) x 935(h) x 525(d)mm*

1200 4 drawer double basin unit
1220(w) x 935(h) x 525(d)mm*

| | | | | | | |
|------------------|---------|-----------|----------|-----------|----------|-----------|
| Matt white | WA9S-MW | £1,000.00 | WA12S-MW | £1,250.00 | WA12D-MW | £1,250.00 |
| Walnut veneer | WA9S-AW | £1,150.00 | WA12S-AW | £1,450.00 | WA12D-AW | £1,450.00 |
| Light oak veneer | WA9S-LO | £1,150.00 | WA12S-LO | £1,450.00 | WA12D-LO | £1,450.00 |

Legs not included. Please choose your leg finish below.

Underslung ceramic basin
450(w) x 160(h) x 350(d)mm

Underslung ceramic basin
420(w) x 130(h) x 360(d)mm

Underslung ceramic basin
420(w) x 130(h) x 360(d)mm

| | | | | | |
|----------|---------|----------|---------|-------------|---------|
| WALUSBAS | £234.50 | WALUSBAS | £234.50 | WALUSBAS x2 | £469.00 |
|----------|---------|----------|---------|-------------|---------|

* Height includes legs and optional upstand

UNDERCOUNTER BASIN WORKTOPS & UPSTANDS

Strata solid surface worktops, pre-finished on all edges and pre-cut to suit undercounter basin units

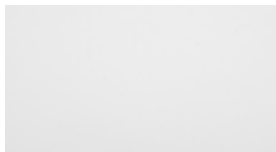

Arctic white



Bianco marble



Black marble

900mm upstand
920(w) x 80(h) x 12(d)mm

| | |
|----------|--------|
| WA9WU-AR | £70.00 |
| WA9WU-BM | £70.00 |
| WA9WU-KM | £70.00 |

900 single basin worktop
920(w) x 25(h) x 530(d)mm

1200 single basin worktop
1220(w) x 25(h) x 530(d)mm

1200 double basin worktop
1220(w) x 25(h) x 530(d)mm

1200mm upstand
1220(w) x 80(h) x 12(d)mm

| | | | | | | | | |
|---------------|----------|---------|-----------|---------|-----------|---------|-----------|--------|
| Arctic white | WA9WS-AR | £375.00 | WA12WS-AR | £510.00 | WA12WD-AR | £550.00 | WA12WU-AR | £80.00 |
| Bianco marble | WA9WS-BM | £375.00 | WA12WS-BM | £510.00 | WA12WD-BM | £550.00 | WA12WU-BM | £80.00 |
| Black marble | WA9WS-KM | £375.00 | WA12WS-KM | £510.00 | WA12WD-KM | £550.00 | WA12WU-KM | £80.00 |

LEG SETS (x4)

Complete the look with our optional furniture legs.



| | | |
|----------------|----------|---------|
| Chrome | WALEG-C | £165.00 |
| Brushed brass | WALEG-A | £165.00 |
| Brushed nickel | WALEG-BN | £165.00 |
| Brushed bronze | WALEG-BZ | £165.00 |

OPTIONAL BASIN OVERFLOW CAPS



| | | |
|----------------|--------|--------|
| Black | OVMCBK | £11.30 |
| Brushed brass | OVMCA | £11.30 |
| Gunmetal | OVMCGM | £11.30 |
| Brushed nickel | OVMCBN | £11.30 |
| Brushed bronze | OVMCBZ | £11.30 |

WALCOT FINISH OPTIONS



Matt white



Walnut veneer



Light oak veneer



WALCOT HANDLES

Handle finishes

- Chrome
- Black
- Brushed brass
- Brushed bronze
- Antique bronze
- Brushed nickel



WALCOT HANDLES

The cost of all handles is listed below. Please note the price listed is for an individual handle, quantity details for each unit size is also supplied



| 1. Toledo pull handles | | RRP _{each} |
|------------------------|--------------|---------------------|
| Chrome | FHTOL-C-160 | £46.70 |
| Black | FHTOL-B-160 | |
| Brushed brass | FHTOL-A-160 | |
| Brushed bronze | FHTOL-BZ-160 | |
| Brushed nickel | FHTOL-BN-160 | |

| 2. Walcot pull handles | | RRP _{each} |
|------------------------|-------------|---------------------|
| Chrome | FHWA-C-160 | £55.00 |
| Black | FHWA-B-160 | |
| Brushed brass | FHWA-A-160 | |
| Antique bronze | FHWA-BR-160 | |
| Brushed nickel | FHWA-BN-160 | |

| 3. Stockton handles | | RRP _{each} |
|---------------------|--------------|---------------------|
| 135mm | | |
| Chrome | SCHH04C.128 | £23.30 |
| Black | SCHH04B.128 | |
| Brushed brass | SCHH04A.128 | |
| Brushed nickel | SCHH04BN.128 | |
| 327mm* | | |
| Chrome | SCHH04C.320 | £30.10 |
| Black | SCHH04B.320 | |
| Brushed brass | SCHH04A.320 | |
| Brushed nickel | SCHH04BN.320 | |
| 500mm* | | |
| Chrome | SCHH04C.492 | £48.60 |
| Black | SCHH04B.492 | |
| Brushed brass | SCHH04A.492 | |
| Brushed nickel | SCHH04BN.492 | |

| 4. Fresno pull handles | | RRP _{each} |
|------------------------|-----------------|---------------------|
| Chrome | FHFREHAN.C.160 | £73.80 |
| Black | FHFREHAN.B.160 | |
| Brushed brass | FHFREHAN.A.160 | |
| Antique bronze | FHFREHAN.BR.160 | |
| Brushed nickel | FHFREHAN.BN.160 | |

| 5. Monterey handles | | RRP _{each} |
|---------------------|--------------|---------------------|
| Chrome | FHMON.C.160 | £29.10 |
| Black | FHMON.B.160 | |
| Brushed brass | FHMON.A.160 | |
| Brushed nickel | FHMON.BN.160 | |

| 6. Tacoma handles | | RRP _{each} |
|-------------------|--------------|---------------------|
| Chrome | FHTAC.C.160 | £29.10 |
| Black | FHTAC.B.160 | |
| Brushed brass | FHTAC.A.160 | |
| Brushed nickel | FHTAC.BN.160 | |

| 7. Washington knobs | | RRP _{each} |
|---------------------|----------|---------------------|
| Chrome | FHWAS.C | £12.40 |
| Black | FHWAS.B | |
| Brushed brass | FHWAS.A | |
| Brushed nickel | FHWAS.BN | |

| 8. Henderson knobs | | RRP _{each} |
|--------------------|---------|---------------------|
| Chrome | FHHEN.C | £12.40 |

| 9. Caldwell knobs | | RRP _{each} |
|-------------------|----------|---------------------|
| Antique bronze | FHCAL.BR | £21.90 |

| 10. Hudson knobs | | RRP _{each} |
|------------------|----------|---------------------|
| Chrome | FHHUD.C | £29.10 |
| Black | FHHUD.B | |
| Brushed brass | FHHUD.A | |
| Brushed bronze | FHHUD.BZ | |
| Brushed nickel | FHHUD.BN | |

| 11. Fresno knobs | | RRP _{each} |
|------------------|----------|---------------------|
| Chrome | FHFRE.C | £35.60 |
| Black | FHFRE.B | |
| Brushed brass | FHFRE.A | |
| Antique bronze | FHFRE.BR | |
| Brushed bronze | FHFRE.BZ | |
| Brushed nickel | FHFRE.BN | |

| 12. Fairfax knobs | | RRP _{each} |
|-------------------|----------|---------------------|
| Chrome | FHFAX.C | £35.60 |
| Black | FHFAX.B | |
| Brushed brass | FHFAX.A | |
| Antique bronze | FHFAX.BR | |
| Brushed bronze | FHFAX.BZ | |
| Brushed nickel | FHFAX.BN | |

| 13. Toledo T-bar knobs | | RRP _{each} |
|------------------------|-------------|---------------------|
| Chrome | FHTOLHAN.C | £29.10 |
| Black | FHTOLHAN.B | |
| Untreated brass | FHTOLHAN.A | |
| Brushed bronze | FHTOLHAN.BZ | |
| Brushed nickel | FHTOLHAN.BN | |

| 14. Walcot knobs | | RRP _{each} |
|------------------|-----------|---------------------|
| Chrome | FHWA-C-0 | £21.80 |
| Black | FHWA-B-0 | |
| Brushed brass | FHWA-A-0 | |
| Antique bronze | FHWA-BR-0 | |
| Brushed nickel | FHWA-BN-0 | |

| 15. Berkeley knobs | | RRP _{each} |
|--------------------|---------|---------------------|
| Chrome | FHBER.C | £36.40 |
| Black | FHBER.B | |
| Brushed brass | FHBER.A | |

| 16. Westport knobs | | RRP _{each} |
|--------------------|---------|---------------------|
| Chrome | FHWST.C | £29.10 |
| Black | FHWST.B | |
| Brushed brass | FHWST.A | |

| Walcot handle quantities per unit | | |
|-----------------------------------|----------|--|
| Unit Size | Quantity | |
| 900 basin unit | 3 | |
| 1200 single/double basin unit | 4 | |

TOLEDO T-BAR HANDLES



Our brass Toledo t-bar pulls feature a living finish that develops subtle colour variations over time, enhancing their character. A metal polish can restore the original look. To prevent wood corrosion and discoloration, remove handles from the vanity before treatment.

*Handles not suitable for tall drawers

FABER

A unique and customizable range offering endless possibilities, complete with striking basin options to suit any style



Matt white



Matt black



Matt burgundy



Sand oak



Tuscan walnut



Matt powder grey



Matt coniston blue



Matt dusk blue



Matt sage green







Bold Burgundy



Dreamy Dusk Blue

Beyond Black



Serene Sage Green

Warmth of Walnut

Faber Finish Options



Unique Furniture

FABER

10
YEAR

GUARANTEE
for all Faber
furniture units

Faber offers endless possibilities, featuring nine stylish finishes, multiple basin options, and a variety of unit sizes. This versatile collection allows you to mix and match components to create custom configurations that perfectly suit your bathroom's size and style, ensuring a personalized and functional space tailored to your needs.

Guaranteed for 10 years, our furniture reflects our promise of enduring quality and craftsmanship.

- Available in nine, style inspired finishes
- Choose from our extensive range of handles. See pg44
- Coordinating Faber products available to create a cohesive bathroom design
Taps p180-183
Showers p222-225 & p238
Accessories p278
Mirrors p310
- Soft close Hettich drawer runners giving a smooth, quiet closing action and luxurious feel

Hettich



TOP RIGHT
600mm wall
mounted unit
in matt black

BOTTOM RIGHT
800mm wall
mounted unit
in matt powder
grey

BOTTOM LEFT
800mm wall
mounted unit
in matt burgundy





FABER 1000
CIRCULAR MIRROR
Other sizes and finishes
available, see page 310

FABER 3 TAP HOLE
BASIN MIXER
Other sizes and finishes available,
see page 180-183

TUSCAN WALNUT
1000 UNIT
Other sizes and finishes available,
see page 42

FABER STORAGE OPTIONS

For extra storage, why not opt for our coordinating wall column – perfectly colour matched to your furniture. Keep it simple with a door overlap for opening or match with the same handles chosen for your faber unit.

Our 200mm tall pull-out drawer unit adds plenty of storage to your unit, and with a soft-close drawer, it ensures a smooth, luxurious closing experience

Alternatively, choose a Vault cabinet to store your bathroom essentials. These cabinets feature colour-matched sides that complement your unit, creating a cohesive and stylish bathroom design.





Simply add a 200mm tall drawer unit to your bathroom configuration, giving you more flexibility to design your space and style. Below are some configurations that could work perfectly in your bathroom.

WORKTOP OPTIONS

600MM UNIT CONFIGURATION

Single unit worktop



600

800MM UNIT CONFIGURATION

Single unit worktop



800

Multiple unit worktop



200 600

1000MM UNIT CONFIGURATIONS

Single unit worktop



1000

Multiple unit worktop



800 200

Multiple unit worktop



200 600 200

Multiple unit worktop

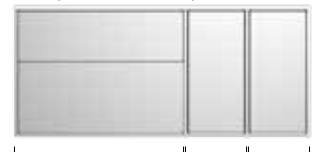

600 200 200

1200MM UNIT CONFIGURATIONS

Multiple unit worktop



1000 200

Multiple unit worktop

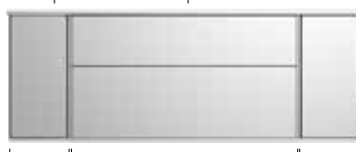

200 800 200

Multiple unit worktop

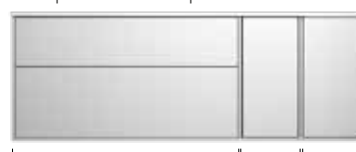

800 200 200

* Chosen countertop basin should be centralised over the main 2 drawer furniture unit

FABER UNITS & STORAGE



600 double drawer basin unit
610(w) x 497(h) x 425(d)mm*
£573.00

Matt white
Matt black
Matt powder grey
Matt sage green
Matt burgundy
Matt coniston blue
Matt dusk blue
Sand oak
Tuscan walnut

FB6D-MW
FB6D-BLK
FB6D-POW
FB6D-SGN
FB6D-BY
FB6D-CB
FB6D-DSK
FB6D-SNO
FB6D-TU



800 double drawer basin unit
810(w) x 497(h) x 425(d)mm*
£615.00

FB8D-MW
FB8D-BLK
FB8D-POW
FB8D-SGN
FB8D-BY
FB8D-CB
FB8D-DSK
FB8D-SNO
FB8D-TU



1000 double drawer basin unit
1010(w) x 497(h) x 425(d)mm*
£695.00

FB10D-MW
FB10D-BLK
FB10D-POW
FB10D-SGN
FB10D-BY
FB10D-CB
FB10D-DSK
FB10D-SNO
FB10D-TU

*Dimensions include basin



200 tall drawer unit
220(w) x 435(h) x 414(d)mm
£485.00

Matt white
Matt black
Matt powder grey
Matt sage green
Matt burgundy
Matt coniston blue
Matt dusk blue
Sand oak
Tuscan walnut

FB2T-MW
FB2T-BLK
FB2T-POW
FB2T-SGN
FB2T-BY
FB2T-CB
FB2T-DSK
FB2T-SNO
FB2T-TU



Back to wall WC unit & worktop
570(w) x 860(h) x 235mm(d)
£401.00

RRBTWFLT.MW
RRBTWFLT.BLK
RRBTWFLT.POW
RRBTWFLT.SGN
RRBTWFLT.BY
RRBTWFLT.CB
RRBTWFLT.DSK
RRBTWFLT.SNO
RRBTWFLT.TU



Storage column
300(w) x 1450(h) x 260(d)mm
Reversible column with door overlap for opening. Additional handles can be purchased and used to match your main furniture piece.
£540.00

RRCOL14.MW
RRCOL14.BLK
RRCOL14.POW
RRCOL14.SGN
RRCOL14.BY
RRCOL14.CB
RRCOL14.DSK
RRCOL14.SNO
RRCOL14.TU

FABER FINISH OPTIONS



Matt white



Matt black



Matt powder grey



Matt sage green



Matt burgundy



Matt coniston blue



Matt dusk blue



Sand oak



Tuscan walnut

FABER BASINS & WORKTOPS



CERAMIC - FABER 1TH



Faber 600 ceramic basin
610(w) x 425(h) x 65(d)mm

1 tap hole DC12071 £252.00



Faber 800 ceramic basin
810(w) x 425(h) x 65(d)mm

1 tap hole DC12072 £330.00



Faber 1000 ceramic basin
1010(w) x 425(h) x 65(d)mm

1 tap hole DC12073 £400.00

CERAMIC - FABER 3TH



Faber 600 ceramic basin
610(w) x 65(h) x 425(d)mm

3 tap hole DC12074 £252.00



Faber 800 ceramic basin
810(w) x 65(h) x 425(d)mm

3 tap hole DC12075 £330.00



Faber 1000 ceramic basin
1010(w) x 65(h) x 425(d)mm

3 tap hole DC12076 £400.00

CERAMIC - PROGRAM 1TH



Program 600 ceramic basin
610(w) x 60(h) x 425(d)mm

1 tap hole DC12012 £252.00



Program 800 ceramic basin
810(w) x 60(h) x 424(d)mm

1 tap hole DC12014 £330.00

OPTIONAL BASIN OVERFLOW CAPS

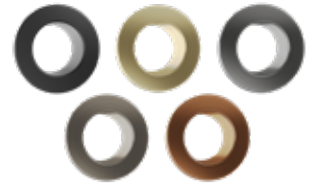

OVERFLOW CAPS - CERAMIC

Black

OVMCBK £11.30

Brushed brass

OVMCA £11.30

Gunmetal

OVMCGM £11.30

Brushed bronze

OVMCBZ £11.30

Brushed nickel

OVMCBN £11.30

COUNTERTOP BASINS & SOLID SURFACE WORKTOPS

Use our counter top basins in conjunction with a solid surface worktop



Bowl counter top basin
380(w) x 155(h) x 380(d)mm

Basin DC12048 £118.00



Square counter top basin
400(w) x 150(h) x 400(d)mm

Basin DC12052 £161.00



Round counter top basin - Black
355(w) x 120(h) x 360(d)mm

Basin DC12050 £214.00



Fluted counter top basin
355(w) x 120(h) x 355(d)mm

Basin DC12054 £161.00



Pill counter top basin
490(w) x 130(h) x 360(d)mm

Basin DC12051 £161.00



Rectangular counter top basin
450(w) x 135(h) x 325(d)mm

Basin DC12053 £161.00



Round counter top basin - White
355(w) x 120(h) x 360(d)mm

Basin DC12049 £134.00

Strata solid surface worktops, pre-finished on all edges and sized to suit either single or multiple unit configurations from previous page

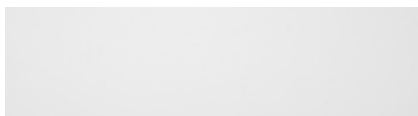

Arctic white



Bianco marble

| | 600mm worktop | | 800mm worktop | | 1000mm worktop | | 1200mm worktop | | | |
|---------------|---------------|---------|---------------|----------------|----------------|----------------|----------------|---------|-----------|---------|
| | Single unit | | Single unit | Multiple units | Single unit | Multiple units | Multiple units | | | |
| Arctic white | FB6WS-AR | £224.00 | FB8WS-AR | FB8WM-AR | £281.00 | FB10WM-AR | FB10WM-AR | £364.00 | FB12WM-AR | £468.00 |
| Bianco marble | FB6WS-BM | £224.00 | FB8WS-BM | FB8WM-BM | £281.00 | FB10WM-BM | FB10WM-BM | £364.00 | FB12WM-BM | £468.00 |



FABER HANDLES

Handle finishes

- Chrome
- Black
- Brushed brass
- Brushed bronze
- Antique bronze
- Brushed nickel

OPT FOR AN ELAN TAP
SEE PAGES
176-179



FABER HANDLES

The cost of all handles is listed below. Please note the price listed is for an individual handle, quantity details for each unit size is also supplied



| 1. Toledo pull handles | | RRP _{each} |
|------------------------|--------------|---------------------|
| Chrome | FHTOL-C-160 | £46.70 |
| Black | FHTOL-B-160 | |
| Brushed brass | FHTOL-A-160 | |
| Brushed bronze | FHTOL-BZ-160 | |
| Brushed nickel | FHTOL-BN-160 | |

| 2. Walcot handles | | RRP _{each} |
|-------------------|-------------|---------------------|
| Chrome | FHWA-C-160 | £55.00 |
| Black | FHWA-B-160 | |
| Brushed brass | FHWA-A-160 | |
| Antique bronze | FHWA-BR-160 | |
| Brushed bronze | FHWA-BZ-160 | |
| Brushed nickel | FHWA-BN-160 | |

| 3. Stockton handles | | RRP _{each} |
|---------------------|--------------|---------------------|
| 135mm | | |
| Chrome | SCHH04C.128 | £23.30 |
| Black | SCHH04B.128 | |
| Brushed brass | SCHH04A.128 | |
| Brushed nickel | SCHH04BN.128 | |
| 327mm* | | |
| Chrome | SCHH04C.320 | £30.10 |
| Black | SCHH04B.320 | |
| Brushed brass | SCHH04A.320 | |
| Brushed nickel | SCHH04BN.320 | |
| 500mm* | | |
| Chrome | SCHH04C.492 | £48.60 |
| Black | SCHH04B.492 | |
| Brushed brass | SCHH04A.492 | |
| Brushed nickel | SCHH04BN.492 | |

| 4. Fresno pull handles | | RRP _{each} |
|------------------------|-----------------|---------------------|
| Chrome | FHFREHAN.C.160 | £73.80 |
| Black | FHFREHAN.B.160 | |
| Brushed brass | FHFREHAN.A.160 | |
| Antique bronze | FHFREHAN.BR.160 | |
| Brushed bronze | FHFREHAN.BZ.160 | |
| Brushed nickel | FHFREHAN.BN.160 | |

| 5. Monterey handles | | RRP _{each} |
|---------------------|--------------|---------------------|
| Chrome | FHMON.C.160 | £29.10 |
| Black | FHMON.B.160 | |
| Brushed brass | FHMON.A.160 | |
| Brushed nickel | FHMON.BN.160 | |

| 6. Tacoma handles | | RRP _{each} |
|-------------------|--------------|---------------------|
| Chrome | FHTAC.C.160 | £29.10 |
| Black | FHTAC.B.160 | |
| Brushed brass | FHTAC.A.160 | |
| Brushed nickel | FHTAC.BN.160 | |

| 7. Washington knobs | | RRP _{each} |
|---------------------|----------|---------------------|
| Chrome | FHWAS.C | £12.40 |
| Black | FHWAS.B | |
| Brushed brass | FHWAS.A | |
| Brushed nickel | FHWAS.BN | |

| 8. Henderson knobs | | RRP _{each} |
|--------------------|---------|---------------------|
| Chrome | FHHEN.C | £12.40 |

| 9. Caldwell knobs | | RRP _{each} |
|-------------------|----------|---------------------|
| Antique bronze | FHCAL.BR | £21.90 |

| 10. Hudson knobs | | RRP _{each} |
|------------------|----------|---------------------|
| Chrome | FHHUD.C | £29.10 |
| Black | FHHUD.B | |
| Brushed brass | FHHUD.A | |
| Brushed bronze | FHHUD.BZ | |
| Brushed nickel | FHHUD.BN | |

| 11. Fresno knobs | | RRP _{each} |
|------------------|----------|---------------------|
| Chrome | FHFRE.C | £35.60 |
| Black | FHFRE.B | |
| Brushed brass | FHFRE.A | |
| Antique bronze | FHFRE.BR | |
| Brushed bronze | FHFRE.BZ | |
| Brushed nickel | FHFRE.BN | |

| 12. Fairfax knobs | | RRP _{each} |
|-------------------|----------|---------------------|
| Chrome | FHFAX.C | £35.60 |
| Black | FHFAX.B | |
| Brushed brass | FHFAX.A | |
| Antique bronze | FHFAX.BR | |
| Brushed bronze | FHFAX.BZ | |
| Brushed nickel | FHFAX.BN | |

| 13. Toledo T-bar knobs | | RRP _{each} |
|------------------------|-------------|---------------------|
| Chrome | FHTOLHAN.C | £29.10 |
| Black | FHTOLHAN.B | |
| Untreated brass | FHTOLHAN.A | |
| Brushed bronze | FHTOLHAN.BZ | |
| Brushed nickel | FHTOLHAN.BN | |

| 14. Walcot knobs | | RRP _{each} |
|------------------|-----------|---------------------|
| Chrome | FHWA-C-0 | £21.80 |
| Black | FHWA-B-0 | |
| Brushed brass | FHWA-A-0 | |
| Antique bronze | FHWA-BR-0 | |
| Brushed bronze | FHWA-BZ-0 | |
| Brushed nickel | FHWA-BN-0 | |

| 15. Berkeley knobs | | RRP _{each} |
|--------------------|---------|---------------------|
| Chrome | FHBER.C | £36.40 |
| Black | FHBER.B | |
| Brushed brass | FHBER.A | |

| 16. Westport knobs | | RRP _{each} |
|--------------------|---------|---------------------|
| Chrome | FHWST.C | £29.10 |
| Black | FHWST.B | |
| Brushed brass | FHWST.A | |

| 17. Catalina handles | | RRP _{each} |
|----------------------|---------------|---------------------|
| Chrome | SCHH09C.150 | £22.70 |
| Black | SCHH09BK.150 | |
| Brushed brass | SCHH09A.150 | |
| Matt white | SCHH09W.150 | |
| Matt powder grey | SCHH09POW.150 | |
| Matt dusk blue | SCHH09DSK.150 | |
| Matt sage green | SCHH09SGN.150 | |
| Matt coniston blue | SCHH09CB.150 | |
| Matt burgundy | SCHH09BY.150 | |

| Faber handle quantities per unit | |
|----------------------------------|----------|
| Unit Size | Quantity |
| 200 unit | 1 |
| 600 basin unit | 2 |
| 800 basin unit | 2 |
| 1000 basin unit | 2 |

TOLEDO T-BAR HANDLES



Our brass Toledo t-bar pulls feature a living finish that develops subtle color variations over time, enhancing their character. A metal polish can restore the original look. To prevent wood corrosion and discoloration, remove handles from the vanity before treatment.

*Handles not suitable for tall drawers

HAMPTON

Inspired by traditional carpentry with a modern twist.



Matt
chalk
white



Matt
agave



Matt
mocha



Matt
slate
grey



Matt
sage
green



Matt
black





Timeless Furniture

HAMPTON

10
YEAR

GUARANTEE
for all Hampton
furniture units

Traditional cabinetry techniques combine with stylish finishes to give a truly classic feel. Hampton features five piece doors with tongue & groove feature side panels. Perfect for creating a stunning & sophisticated look in the bathroom.

Guaranteed for 10 years, our furniture reflects our promise of enduring quality and craftsmanship.

- Available in six, heritage inspired finishes
- Chrome knobs as standard, or choose from our choice of handles to make yours unique. See page p112



TOP RIGHT
600mm undercounter
basin unit in matt agave

BOTTOM RIGHT
1200mm undercounter
basin unit in matt chalk
white

BOTTOM LEFT
800mm undercounter
basin unit in matt mocha

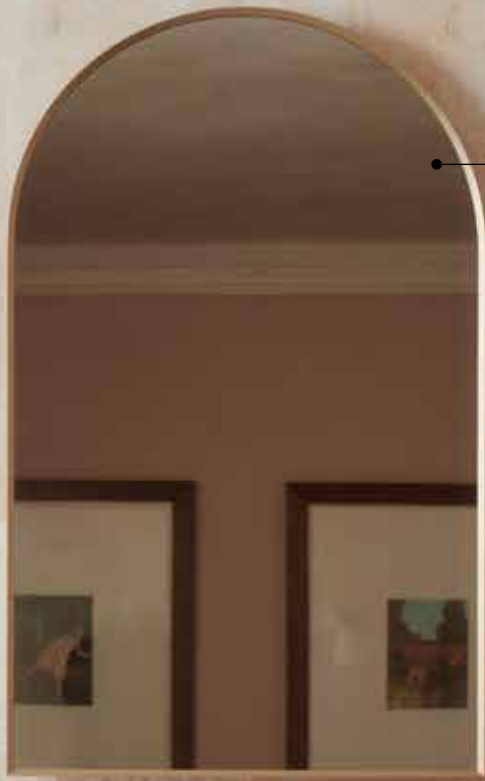

THEISIS MIRROR
Complete the look with a brushed brass Thesis mirror, other finishes & styles available see page 320

KESWICK TAP
Other finishes available, see pages 196-199



TOLEDO T-BAR HANDLE
Choose from our range of handles on page 112

MATT BLACK 800 HAMPTON UNIT
Other sizes and finishes available, see pages 50-53





600 undercounter basin unit
586(w) x 835(h) x 465(d)mm

£600.00

- Matt chalk white
- Matt agave
- Matt mocha
- Matt slate grey
- Matt sage green
- Matt black

HAM600US.W

HAM600US.AG

HAM600US.MC

HAM600US.SG

HAM600US.SGN

HAM600US.BLK

Undercounter ceramic basin
460(w) x 180(h) x 330(d)mm

HAMUSC1

£170.00



800 undercounter basin unit
815(w) x 840(h) x 470(d)mm

£1,030.00

HAM800B.W

HAM800B.AG

HAM800B.MC

HAM800B.SG

HAM800B.SGN

HAM800B.BLK

Undercounter ceramic basin
460(w) x 180(h) x 330(d)mm

HAMUSC1

£170.00



1200 undercounter basin unit
2x 586(w) x 835(h) x 465(d)mm

£1,200.00

2 x HAM600US.W

2 x HAM600US.AG

2 x HAM600US.MC

2 x HAM600US.SG

2 x HAM600US.SGN

2 x HAM600US.BLK

Undercounter ceramic basin
460(w) x 180(h) x 330(d)mm

2x HAMUSC1

£340.00



Slim back to wall WC unit & colour matched worktop
576(w) x 860(h) x 230(d)mm

£459.00

HAM560BTW.W

HAM560BTW.AG

HAM560BTW.MC

HAM560BTW.SG

HAM560BTW.SGN

HAM560BTW.BLK

For cistern options see page 162

Chrome knobs provided as standard - for other handle options see page 112

UNDERCOUNTER BASIN WORKTOPS & UPSTANDS

Strata solid surface worktops, pre-finished on all edges and pre-cut to suit undercounter basin units

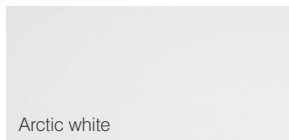

600 strata worktop & upstand
25mm thick 600(l) x 475(w)mm

Arctic white HAMW620-AR **£256.00**

Carrara HAMW620-CA **£256.00**

800 strata worktop & upstand
25mm thick 830(l) x 475(w)mm

Arctic white HAMW820-AR **£307.00**

Carrara HAMW820-CA **£307.00**

1200 strata worktop & upstand
25mm thick 1186(l) x 475(w)mm

Arctic white HAMW1220-AR **£515.00**

Carrara HAMW1220-CA **£515.00**



HAMPTON FINISH OPTIONS



Matt chalk white



Matt agave



Matt mocha



Matt slate grey



Matt black



Matt sage green

THESIS ARCH MIRROR
Other styles and finishes
available, see page 320

KESWICK
BASIN MIXER
Other styles and
finishes available,
see pages 196-199

MATT BLACK
575 HAMPTON UNIT
Other sizes and finishes
available, see pages 50-53
Handle options, page 112

HAMPTON FULLY
ENCLOSED WC
& SOFT CLOSE SEAT
Other styles available,
see page 148

THEISIS ARCH MIRROR
Other styles and finishes
available, see page 320



HAMPTON FULLY
ENCLOSED WC
& SOFT CLOSE SEAT
Other styles available,
see page 148



SAGE GREEN
450 HAMPTON UNIT
Other sizes and finishes
available, see pages 50-53.
Handle options, page 112



REVERSIBLE
DOOR

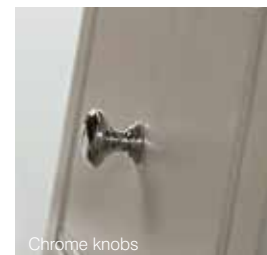

450 cloakroom basin unit*
410(w) x 730(h) x 360(d)mm

£468.00

575 freestanding basin unit
530(w) x 745(h) x 370(d)mm

£605.00

700 freestanding basin unit*
665(w) x 750(h) x 400(d)mm

£670.00

- Matt chalk white
- Matt agave
- Matt mocha
- Matt slate grey
- Matt sage green
- Matt black

HAM450B.W

HAM450B.AG

HAM450B.MC

HAM450B.SG

HAM450B.SGN

HAM450B.BLK

HAM550B.W

HAM550B.AG

HAM550B.MC

HAM550B.SG

HAM550B.SGN

HAM550B.BLK

HAM700B.W

HAM700B.AG

HAM700B.MC

HAM700B.SG

HAM700B.SGN

HAM700B.BLK

Cloakroom ceramic basin
420(w) x 130(h) x 360(d)mm

HAM450C

£167.00

575 ceramic basin
575(w) x 120(h) x 390(d)mm

HAM560C

£171.50

DC14001

£171.50

DC14032

£171.50

700 ceramic basin

710(w) x 125(h) x 420(d)mm

HAM700C

£307.00

* Not compatible with optional basin overflow caps

- 1 tap hole
- 2 tap holes
- 3 tap holes



Brass hinge upgrade
(Set of 4)
HAMHNGSET.A **£20.80**



PAGE
344

Front bath panel
1695(w) x 500(h)mm
£223.50

End bath panel
685(w) x 500(h)mm
£124.50

Painted wooden toilet seat
375(w) x 60(h) x 428(d)mm
£135.00

- Matt chalk white
- Matt agave
- Matt mocha
- Matt slate grey
- Matt sage green
- Matt black

DC5003F

DC5008F

DC5004F

DC5005F

DC5026F

DC5025F

DC5003E

DC5008E

DC5004E

DC5005E

DC5026E

DC5025E

-

DC4010-SF

DC4006-SF

-

-

-



SOFT
CLOSE

OPTIONAL BASIN OVERFLOW CAPS

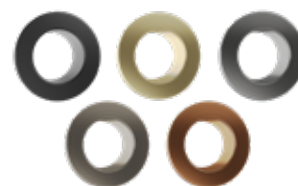

Black

OVMCBK

£11.30

Brushed brass

OVMCA

£11.30

Gunmetal

OVMCGM

£11.30

Brushed bronze

OVMCBZ

£11.30

Brushed nickel

OVMCBN

£11.30



WIDCOMBE

A stunning range of freestanding furniture, Widcombe pairs classic shaker-style with modern ingenuity.



Matt
canvas



Matt
parchment



Matt
pewter



Matt
twilight



Timeless Furniture

WIDCOMBE

10
YEAR

GUARANTEE
for all Widcombe
furniture units

Traditional cabinetry techniques combine with modern features to create Widcombe's timeless style. Featuring 5-piece doors and crafted shaker side panels. Available in a classic straight or curved styling option and four painted finishes, Widcombe is a truly customisable range.

Guaranteed for 10 years, our furniture reflects our promise of enduring quality and craftsmanship.

- 5-piece doors and crafted shaker side panels
- Available in a classic straight or curved styling option
- Four painted finishes
- All Widcombe furniture benefits from a 10 year guarantee



TOP RIGHT
1200mm double basin unit in twilight with worktop & undercounter basins

BOTTOM RIGHT
1200mm single basin unit in canvas with worktop & undercounter basin

LEFT
1200mm curved double basin unit in pewter with worktop & countertop basin



WALCOT PILL MIRROR
Other finishes and sizes
available, see page 308

WALCOT
BASIN MIXER
Other styles available
see pages 248-251

FRESNO PULL HANDLE
Choose from our range of
handles on page 112

PARCHMENT 800 UNIT
WITH UNDERCOUNTER
BASIN & WORKTOP
Other finishes available
see page 58



ALL REQUIRE WORKTOP



1200 single basin unit
1220(w) x 860(h) x 520(d)mm

£1,540.00



1200 double basin unit
1220(w) x 860(h) x 520(d)mm

£1,540.00



1200 single curved basin unit
1220(w) x 860(h) x 520(d)mm

£1,810.00



1200 double curved basin unit
1220(w) x 860(h) x 520(d)mm

£1,810.00

Canvas
Parchment
Pewter
Twilight

WMB13103

WMB13104

WMB13105

WMB13111

WMB13103

WMB13104

WMB13105

WMB13111

WMB13065

WMB13064

WMB13069

WMB13109

WMB13065

WMB13064

WMB13069

WMB13109

Undercounter ceramic basin
475(w) x 205(h) x 380(d)mm

WMB13004

£234.50

Undercounter ceramic basin
475(w) x 205(h) x 380(d)mm

2x WMB13004

£469.00

Undercounter ceramic basin
475(w) x 205(h) x 380(d)mm

WMB13004

£234.50

Undercounter ceramic basin
475(w) x 205(h) x 380(d)mm

2x WMB13004

£469.00

For handle options see page 112

WORKTOP OPTIONS (For use with 1200 units only)

Solid surface worktops - not pre-drilled



Solid Surface - Carrara

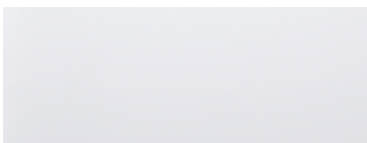

Solid Surface - White

Marble worktops - pre-drilled



Honed marble

1200 single basin worktop

Carrara
White

WMB13087

£510.00

WMB13086

£510.00

1200 double basin worktop

WMB13089

£550.00

WMB13088

£550.00

1200 curved single basin worktop

WMB13081

£510.00

WMB13080

£510.00

1200 curved double basin worktop

WMB13083

£550.00

WMB13082

£550.00

Honed mable
1 tap hole
3 tap hole

WMB13113

£910.00

WMB13128

£910.00

WMB13114

£1,100.00

WMB13129

£1,100.00

WMB13067

£910.00

WMB13125

£910.00

WMB13076

£1,100.00

WMB13126

£1,100.00



1 tap hole option



3 tap hole option

OPTIONAL BASIN OVERFLOW CAPS



Black

OVMCBK

£11.30

Brushed nickel

OVMCBN

£11.30

Brushed brass

OVMCA

£11.30

Brushed bronze

OVMCBZ

£11.30

Gunmetal cap

OVMCGM

£11.30

WIDCOMBE FINISH OPTIONS



Canvas



Parchment



Pewter



Twilight

FOR
HANDLE
OPTIONS SEE
PAGE 112

THEISIS ARCH MIRROR
Other finishes and sizes
available, see page 320



KESWICK BASIN MIXER
Other finishes and styles
available, see pages 196-199



WIDCOMBE 1200 UNIT
Other finishes and sizes
available, see pages 58-61



WESSEX 3TH
BASIN MIXER
Other finishes available,
see pages 200

HONED MARBLE
WORKTOP
Other styles available
see page 61

WIDCOMBE 800 UNIT
Other finishes and sizes
available, see pages 58-61

ALL REQUIRE WORKTOP



600 freestanding basin unit
620(w) x 860(h) x 520(d)mm
£905.00

800 freestanding basin unit
820(w) x 860(h) x 520(d)mm
£1,080.00

Canvas
Parchment
Pewter
Twilight

WMB13100
WMB13101
WMB13102
WMB13110

WMB13134
WMB13133
WMB13135
WMB13136

Undercounter ceramic basin
475(w) x 205(h) x 380(d)mm
WMB13004 **£234.50**

Undercounter ceramic basin
475(w) x 205(h) x 380(d)mm
WMB13004 **£234.50**

For handle options see page 112



Complete the look of your Widcombe bathroom with one of our elegant Traditional mirrors. See page 321 for further details.

WORKTOP OPTIONS

Solid surface worktops - not pre-drilled

Marble worktops - pre-drilled



Solid Surface - Carrara

Solid Surface - White

Honed marble

600 basin worktop
Carrara WMB13085 **£266.00**
White WMB13084 **£266.00**

800 basin worktop
WMB13090 **£239.50**
-

Honed marble
1 tap hole
3 tap hole

WMB13112 **£540.00**
-

WMB13131 **£650.00**
WMB13132 **£650.00**



Chrome knobs provided as standard - for other handle options see page 112

BATH PANELS



Front bath panel
1695(w) x 450(h) x 22(d)mm
£223.50

End bath panel
695(w) x 450(h) x 22(d)mm
£124.50

Canvas DC5009F
Parchment DC5013F
Pewter DC5006F
Twilight DC5014F

Canvas DC5009E
Parchment DC5013E
Pewter DC5006E
Twilight DC5014E

A plinth is supplied with the panels and enables height adjustment between 450 - 590mm



Canvas



Parchment



Pewter



Twilight

CONCIERGE

An elegant mix of old and new,
at home in any setting.



Matt
white



Matt
carbon



Matt
coniston
blue



Matt
juniper
green





Luxurious Furniture

CONCIERGE

10
YEAR

GUARANTEE
for all Concierge
furniture units

A distinctive furniture collection that seamlessly marries traditional and contemporary styles, Concierge is available in a signature palette of finishes and three sizes to suit any layout. With ample drawer space and tall storage to meet the demands of the modern bathroom.

Guaranteed for 10 years, our furniture reflects our promise of enduring quality and craftsmanship.

- A freestanding vanity with three drawers
- Tall storage space (800 & 1000 units only)
- Featuring 2 distinct basin options
- Choose from four versatile finishes
- Available in three sizes
- Soft close Hettich drawer runners giving a smooth, quiet closing action and luxurious feel

Hettich



TOP RIGHT
600mm basin unit
in matt carbon

BOTTOM RIGHT
Fresno handle
& knob detail

LEFT
Tall drawer detail
in juniper green



THESIS MIRROR
Other sizes, shapes & finishes
available. See page 320

FLUTED LIGHTING
See pages 296

STORM NOVA
BASIN MIXER
Other finishes available
see pages 184-187

JUNIPER GREEN 800 BASIN UNIT
Other finishes available
see page 68



Luxurious Furniture

HANDLES, LIGHTING, MIRRORS & CABINETS

Add the finishing touch by opting for one of our colour matched cabinets, specifically designed to complement the luxurious look and feel of your Concierge furniture.

Create beautiful spaces with our lighting designs. Available in three finishes, our extensive range of wall lights and light pendants offer form and functionality.

Bring a singular look to your vanity with our extensive collection of hardware, handles and pulls. Choose from mirror-shine chrome handles, rich bronze, brushed nickel & brass or graphic black, available in an array of shapes and styles. See more on page 112.

Guaranteed for 10 years, our furniture reflects our promise of enduring quality and craftsmanship.

- Cabinets available in aluminium, black, brushed brass or brushed bronze plus a further 19 finishes to match our furniture
- Extensive range of wall lights and pendant lighting to complement furniture
- Choose from extensive range of handle designs. See page 112-113.
- Handles available in chrome, brass, bronze, nickel and matt black finishes



PAGE
297



PAGE
68

TOP RIGHT
Fluted lighting pendants in black

MIDDLE
Washington knobs in black

BOTTOM RIGHT
Toledo handle in brushed brass

LEFT
Colour matched cabinet in brass with mirrored sides



PAGE
112

LINK MIRROR
Other sizes available.
See page 315

FLUTED LIGHTING
See pages 296

STORM NOVA
BASIN MIXER
Other finishes available
see pages 184-187

MATT WHITE 1000 BASIN UNIT
Other finishes available
see page 68

CONCIERGE UNITS



600 freestanding basin unit
585(w) x 780(h) x 415(d)mm
£765.00

- Matt white
- Matt carbon
- Coniston blue
- Juniper green

600 ceramic basin
600(w) x 80(h) x 465(d)mm
ACY600C £398.00

For handle options see page 112



800 freestanding basin unit
785(w) x 780(h) x 415(d)mm
£1,020.00

- CCG8F.MW
- CCG8F.MCB
- CCG8F.CB
- CCG8F.JNP

800 ceramic basin
800(w) x 80(h) x 465(d)mm
ACY800C £496.00



1000 freestanding basin unit
985(w) x 780(h) x 415(d)mm
£1,420.00

- CCG10F.MW
- CCG10F.MCB
- CCG10F.CB
- CCG10F.JNP

1000 ceramic basin
1000(w) x 80(h) x 465(d)mm
ACY1000C £570.00

OPTIONAL BASIN
OVERFLOW CAPS

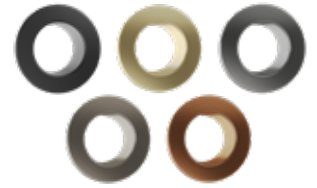

| | |
|-----------------------|--------|
| Black | |
| OVMCBK | £11.30 |
| Brushed brass | |
| OVMCA | £11.30 |
| Gunmetal | |
| OVMCGM | £11.30 |
| Brushed nickel | |
| OVMCBN | £11.30 |
| Brushed bronze | |
| OVMCBZ | £11.30 |



Back to wall WC unit & worktop
570(w) x 860(h) x 235(d)mm
£401.00

- Matt white
- Matt carbon
- Coniston blue
- Juniper green

- RRBTWFLT.MW
- RRBTWFLT.MCB
- RRBTWFLT.CB
- RRBTWFLT.JNP



Universal wall column*
300(w) x 1450(h) x 260(d)mm
£540.00

- RRCOL14.MW
- RRCOL14.MCB
- RRCOL14.CB
- RRCOL14.JNP

* Reversible column with door overlap for opening. Additional handles can be purchased and used to match your main furniture piece.



CABINETS

Concierge recessed illuminated cabinets
Choose your cabinet finish and size (no sides included)

| | Silver | | Black | | Brushed brass | | Brushed bronze | |
|----------|--------|---------|-----------|---------|---------------|---------|----------------|---------|
| Size | Code | RRP | Code | RRP | Code | RRP | Code | RRP |
| 500x700 | VTC050 | £565.00 | VTC050-BL | £675.00 | VTC050-BR | £675.00 | VTC050-BZ | £675.00 |
| 650x700 | VTC065 | £675.00 | VTC065-BL | £775.00 | VTC065-BR | £775.00 | VTC065-BZ | £775.00 |
| 800x700 | VTC080 | £775.00 | VTC080-BL | £885.00 | VTC080-BR | £885.00 | VTC080-BZ | £885.00 |
| 1000x700 | VTC100 | £885.00 | VTC100-BL | £995.00 | VTC100-BR | £995.00 | VTC100-BZ | £995.00 |

Concierge surface mounted illuminated cabinets
Order cabinet above and side kits below

| Finish | Code | RRP |
|---------------|-------------|---------|
| Matt white | RRC-CSK.MW | £107.50 |
| Matt carbon | RRC-CSK.MCB | £107.50 |
| Coniston blue | RRC-CSK.CB | £107.50 |
| Juniper green | RRC-CSK.JNP | £107.50 |



For other handle options see page 112

CONCIERGE FINISH OPTIONS

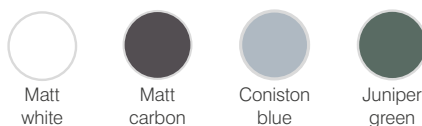

RITUAL MIRROR
Other sizes available.
See page 314

GLOBE LIGHTING
See pages 296

UNITY DUAL
FUNCTION SHOWER
Other styles & finishes
available. See pages
226-229

FRESNO
PULL HANDLE
Other handles available
see page 112

JUNIPER GREEN 1000 BASIN UNIT
Other finishes available
see page 70



FAIRMONT

Mid-century modern design with contemporary finishing touches



Gloss white



Matt agave



Matt carbon



Matt terra





Luxurious Furniture
FAIRMONT

10
YEAR

GUARANTEE
for all Fairmont
furniture units

A contemporary take on mid-century modern aesthetic. This range of modular furniture features three size options, each with ample drawer space giving you maximised storage where you need it most. Customise yours with our extensive range of handle options and tailor to suit your style. See page 112

Guaranteed for 10 years, our furniture reflects our promise of enduring quality and craftsmanship.



- Unit can be wall hung or freestanding, with optional matt black or brass legs to complete the mid-century modern look
- Spacious ceramic basin
- Expansive storage across three sizes with optional beech storage boxes
- High quality Hettich soft close runner drawers giving you a smooth, luxurious closing action



TOP RIGHT
800mm basin unit
in matt carbon

TOP LEFT
800mm basin
unit in matt agave
without legs

BOTTOM RIGHT
600mm basin unit
in matt agave

BOTTOM LEFT
1000mm basin
unit & wall column
in terra



FLUTED PENDANT LIGHTS
Other finishes and styles available.
See page 296

FRAME 800 MIRROR
Other finishes and sizes available.
See page 319

STORM NOVA
BASIN MIXER
See pages 184-187
for all other finishes

TOLEDO TBAR HANDLES
See page 112 for all
handle options

MATT CARBON 800 UNIT
Other finishes available
see page 76

Luxurious Furniture

FAIRMONT HANDLES, LIGHTING & STORAGE

Add the finishing touch by opting for one of our colour matched cabinets, specifically designed to complement the luxurious look and feel of your Fairmont furniture.

Create beautiful spaces with our lighting designs. Available in two finishes, our extensive range of wall lights and light pendants offer form and functionality.

Make your piece unique with our expansive selection of knobs and handles. Choose from colour matched handles, highly polished chrome, timeless bronze, brushed brass, brushed nickel or moody matt black, available in a wide range of shapes and styles. See more on page 76.

- Cabinets available in aluminium, black or brushed brass with 19 panel side finish options
- Extensive range of wall lights and pendant lighting to complement furniture
- Choose from our extensive range of handles or knob designs. Available in multiple finishes. See page 112
- Handles colour matched to your furniture are also available



TOP RIGHT
Fluted light pendants in brushed brass with 800 matt carbon unit

BOTTOM RIGHT
600 drawer unit with black legs in matt agave & boost cabinet

LEFT
Catalina colour matched handles in matt agave





PARADIGM
Close coupled WC
see page 158

WASHINGTON KNOBS
Black finish, other options
available, see page 112

GLOSS WHITE 800 UNIT
Other finishes available
see page 76



LEG-SETS

Complete the mid-century modern look with our optional furniture legs in either black or brushed brass.



600 freestanding basin unit
592(w) x 670(h) x 452(d)mm

£785.00

800 freestanding basin unit
795(w) x 670(h) x 452(d)mm

£1,040.00

1000 freestanding basin unit
995(w) x 670(h) x 452(d)mm

£1,450.00

Gloss white

FAR6F.W

FAR8F.W

FAR10F.W

Matt agave

FAR6F.AGM

FAR8F.AGM

FAR10F.AGM

Matt carbon

FAR6F.MCB

FAR8F.MCB

FAR10F.MCB

Terra

FAR6F.TER

FAR8F.TER

FAR10F.TER

600 ceramic basin
630(w) x 65(h) x 480(d)mm

FAR600C

£325.00

800 ceramic basin
830(w) x 65(h) x 480(d)mm

FAR800C

£390.00

1000 ceramic basin
1030(w) x 65(h) x 480(d)mm

FAR1000C

£520.00

Optional 600 leg-set
140(h)mm

FARLEG600

£159.00

Optional 800 leg-set
140(h)mm

FARLEG800

£165.50

Optional 1000 leg-set
140(h)mm

FARLEG1000

£172.00

Black

FARLEG600A

£204.50

FARLEG800A

£211.50

FARLEG1000A

£217.50

Brushed brass

For handle options see page 112



Back to wall WC unit & worktop
570(w) x 860(h) x 235(d)mm

£401.00



Storage column
300(w) x 1450(h) x 260(d)mm

£540.00

Gloss white

RRBTWFLT.W

RRCOL14.GW

Matt agave

RRBTWFLT.AGM

RRCOL14.AGM

Matt carbon

RRBTWFLT.MCB

RRCOL14.MCB

Terra

RRBTWFLT.TER

RRCOL14.TER

* Reversible column with door overlap for opening. Additional handles can be purchased and used to match your main furniture piece.

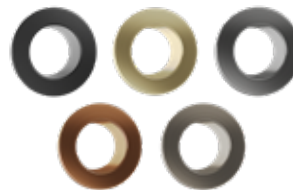

BASIN OVERFLOW CAPS

Black

OVMCBK

£11.30

Brushed brass

OVMCA

£11.30

Gunmetal

OVMCGM

£11.30

Brushed bronze

OVMCBZ

£11.30

Brushed nickel

OVMCBN

£11.30

Beech storage boxes (set of 2)

Add to the practicality of your Fairmont furniture units with a set of 2 beech boxes with lids to keep all your bathroom bits and bobs together inside the main drawer.

Small box
100(w) x 55(h) x 270(d)mm
Large box
200(w) x 55(h) x 270(d)mm

BOXSET19

£146.00



For other handle options see page 112

CABINETS

Fairmont recessed illuminated cabinets

Choose your cabinet finish and size (no sides included)

| | Silver | | Black | | Brushed brass | | Brushed bronze | |
|----------|--------|---------|-----------|---------|---------------|---------|----------------|---------|
| Size | Code | RRP | Code | RRP | Code | RRP | Code | RRP |
| 500x700 | VTC050 | £565.00 | VTC050-BL | £675.00 | VTC050-BR | £675.00 | VTC050-BZ | £675.00 |
| 650x700 | VTC065 | £675.00 | VTC065-BL | £775.00 | VTC065-BR | £775.00 | VTC065-BZ | £775.00 |
| 800x700 | VTC080 | £775.00 | VTC080-BL | £885.00 | VTC080-BR | £885.00 | VTC080-BZ | £885.00 |
| 1000x700 | VTC100 | £885.00 | VTC100-BL | £995.00 | VTC100-BR | £995.00 | VTC100-BZ | £995.00 |

Fairmont surface mounted illuminated cabinets

Order cabinet above and sides kit below

| Finish | Code | RRP |
|-------------|-------------|---------|
| Gloss white | RRC-CSK.W | £107.50 |
| Matt carbon | RRC-CSK.MCB | £107.50 |
| Matt agave | RRC-CSK.AGM | £107.50 |
| Terra | RRC-CSK.TER | £107.50 |



FLUTED PENDANT LIGHTS
Other finishes and styles available.
See page 296

FRAME 1000 MIRROR
Other finishes and sizes available.
See page 319

STORM NOVA
BASIN MIXER
See pages 184-187
for all other finishes

WASHINGTON
KNOBS
Black finish, other
options available,
see page 112

FAIRMONT 1000
UNIT IN TERRA
Other sizes and finishes
available available,
see page 76





SCHEME

Contemporary tailored furniture.
Tweak every detail to suit your space & style.

Slab

-  Gloss white
-  Matt derwent blue
-  Matt carbon
-  Matt juniper green
-  Gloss light grey
-  Sand oak

Fluted

-  Matt white
-  Matt derwent blue
-  Matt carbon
-  Matt juniper green
-  Sand oak



Unique Furniture

SCHEME - ONE RANGE, TWO STYLES

SLAB
STYLING





10
YEAR

GUARANTEE
for all Scheme
furniture units

SCHEME

Our Scheme furniture has something to suit every taste. Opt for our sleek slab door or choose our alternate fluted front door style. Comprising a comprehensive selection of basin unit sizes, basin types, stunning furniture finishes & handle options, you can tweak every detail to perfectly suit your space & personal sense of style.

Guaranteed for 10 years, our furniture reflects our promise of enduring quality and craftsmanship.

- Pair with sleek colour matched handle for complete cohesion. Available in two sizes 600 & 800mm. Cloakroom options are also available for smaller spaces
- Built-in drawer dividers and optional beech storage boxes
- Soft close drawer runners and door hinges giving a smooth, quiet closing action and luxurious feel



TOP RIGHT
450 wall mounted
basin unit in gloss
light grey

BOTTOM RIGHT
800mm unit in matt
juniper green

LEFT
800mm unit in
matt carbon with
counter top basin



FLUTED PENDANT LIGHTING
Other finishes and styles available. See page 296

LOOP MIRROR & VANITY MIRROR
Other sizes, styles & finishes available. See page 306

METRIC BASIN MIXER
Other finishes available see page 188

MATT CARBON FLUTED 600 UNIT
Other finishes available see page 87



Unique Furniture

SCHEME - BASINS

Your choice of basin is key to the look and feel of your unit. Our basin collection provides you with multiple possibilities to create something truly unique for your Scheme furniture.

- Scheme cloakroom basin is compact and neat, featuring a corner design with a single corner tap hole
- Our Frame ceramic basin can also be used with Scheme to achieve a smooth, straight profile
- Isocast basins inspired by high end premium hotels provide useful extra surface space in the bathroom and are available in a luxurious double basin style
- Unique counter top basins in a range of shapes and sizes, mounted onto solid surface worktops give you that spa feeling at home



COUNTERTOP
BASIN



SCHEME
BASIN

TOP RIGHT
Matt fluted unit in matt white with bianco marble work top and black countertop basin

BOTTOM RIGHT
800mm fluted unit in juniper green with frame ceramic basin

BOTTOM LEFT
450 unit in matt derwent blue with scheme cloakroom basin



FRAME
BASIN

Unique Furniture

SCHEME - STORAGE

For extra storage, why not opt for our coordinating cabinets or wall column – perfectly colour matched to your furniture with ample internal. Keep it simple with a door overlap for opening or match with the same handles chosen for your scheme unit.

Our wooden drawer dividers too add practicality to the bathroom, helping to keep all of your bits and bobs in place.



SCHEME SLAB UNITS & HANDLES



450 wall mounted basin unit
445(w) x 575(h) x 280(d)mm

£337.00

| | |
|------------------|----------|
| Gloss white | ESWM45W |
| Derwent blue | - |
| Matt carbon | - |
| Juniper green | - |
| Gloss light grey | ESWM45LG |
| Sand oak** | - |



450 freestanding basin unit
445(w) x 820(h) x 280(d)mm

£374.00

| |
|-----------|
| ESVB45W |
| ESVB45DB |
| ESVB45MCB |
| ESVB45JNP |
| ESVB45LG |
| ESVB45SNO |



600 wall mounted basin unit with double drawer
595(w) x 495(h) x 390(d)mm

£630.00

| |
|-------------|
| SCH600D.GW |
| SCH600D.DB |
| SCH600D.MCB |
| SCH600D.JNP |
| SCH600D.LG |
| SCH600D.SNO |



800 wall mounted basin unit with double drawer
795(w) x 495(h) x 390(d)mm

£775.00

| |
|-------------|
| SCH800D.GW |
| SCH800D.DB |
| SCH800D.MCB |
| SCH800D.JNP |
| SCH800D.LG |
| SCH800D.SNO |

**Sand Oak Furniture Grain

Scheme slab units, columns & back to wall WC units have a horizontal grain on the front. Scheme fluted units have a vertical grain on fronts

SCHEME SLAB HANDLE OPTIONS

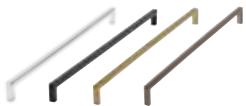

Stockton handles

| | | | |
|----------------|--------------|---------------|--|
| Chrome | | | |
| 128mm centres | SCHH04C.128 | £23.30 | |
| 320mm centres | SCHH04C.320 | £30.10 | |
| 492mm centres* | SCHH04C.492 | £48.60 | |
| Matt black | | | |
| 128mm centres | SCHH04B.128 | £23.30 | |
| 320mm centres | SCHH04B.320 | £30.10 | |
| 492mm centres* | SCHH04B.492 | £48.60 | |
| Brass | | | |
| 128mm centres | SCHH04A.128 | £23.30 | |
| 320mm centres | SCHH04A.320 | £30.10 | |
| 492mm centres* | SCHH04A.492 | £48.60 | |
| Brushed nickel | | | |
| 128mm centres | SCHH04BN.128 | £23.30 | |
| 320mm centres | SCHH04BN.320 | £30.10 | |
| 492mm centres* | SCHH04BN.492 | £48.60 | |



Scheme handle no.8

| | | | |
|----------------|-------------|---------------|--|
| Chrome | | | |
| 128mm centres | SCHH08C.128 | £32.10 | |
| 224mm centres* | SCHH08C.224 | £56.00 | |



Sedona handles

| | | | |
|---------------|--------------|---------------|--|
| Chrome | | | |
| 160mm centres | SCHH02C.160 | £29.10 | |
| 256mm centres | SCHH02C.256 | £48.00 | |
| 384mm centres | SCHH02C.384 | £59.60 | |
| Black | | | |
| 160mm centres | SCHH02B.160 | £29.10 | |
| 256mm centres | SCHH02B.256 | £48.00 | |
| 384mm centres | SCHH02B.384 | £59.60 | |
| Gunmetal | | | |
| 160mm centres | SCHH02GM.160 | £29.10 | |

FOR ALTERNATIVE HANDLE OPTIONS SEE PAGE 112



Catalina colour matched handles

| | | | |
|-----------------|---------------|---------------|--|
| 150mm length | | | |
| ○ White | SCHH09W.150 | £22.70 | |
| ● Derwent Blue | SCHH09DB.150 | £22.70 | |
| ● Light Grey | SCHH09LG.150 | £22.70 | |
| ● Carbon | SCHH09MCB.150 | £22.70 | |
| ● Juniper Green | SCHH09JNP.150 | £22.70 | |
| ● Black | SCHH09BK.150 | £22.70 | |
| ● Chrome | SCHH09C.150 | £22.70 | |
| ● Brushed brass | SCHH09A.150 | £22.70 | |



Monterey handles

| | | | |
|---------------|--------------|---------------|--|
| Chrome | | | |
| 160mm centres | FHMON.C.160 | £29.10 | |
| Black | | | |
| 160mm centres | FHMON.B.160 | £29.10 | |
| Brushed brass | | | |
| 160mm centres | FHMON.A.160 | £29.10 | |
| Gunmetal | | | |
| 160mm centres | FHMON.BN.160 | £29.10 | |

* Not suitable for 450mm units

SCHEME SLAB FINISH OPTIONS



SCHEME FLUTED FINISH OPTIONS

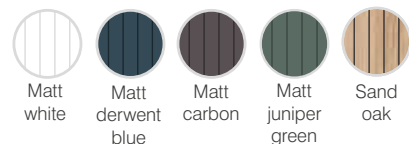

SCHEME FLUTED UNITS & HANDLES



600 wall mounted basin unit with double drawer
595(w) x 495(h) x 390(d)mm

£630.00



800 wall mounted basin unit with double drawer
795(w) x 495(h) x 390(d)mm

£775.00

Matt white
Derwent blue
Matt carbon
Juniper green
Sand oak**

SCHFL600D.MW
SCHFL600D.DB
SCHFL600D.MCB
SCHFL600D.JNP
SCHFL600D.SNO

SCHFL800D.MW
SCHFL800D.DB
SCHFL800D.MCB
SCHFL800D.JNP
SCHFL800D.SNO



CATALINA COLOUR MATCHED HANDLES

Handles

Due to fluting style – Catalina handles should be used either in chrome, black or colour matched to your furniture.



Beech storage boxes (set of 2)

Add to the practicality of your Scheme furniture units with a set of 2 beech boxes with lids to keep all your bathroom bits and bobs together inside the main drawer.

Small box
100(w) x 55(h) x 270mm(d)
Large box
200(w) x 55(h) x 270mm(d)

BOXSET19 £146.00

SCHEME LIGHTING, STORAGE & CABINETS



Back to wall WC unit & worktop

570(w) x 860(h) x 235mm(d)

£401.00

Gloss white
Matt white
Derwent blue
Matt carbon
Juniper green
Gloss light grey
Sand oak**

RRBTWFLT.W
RRBTWFLT.MW
RRBTWFLT.DB
RRBTWFLT.MCB
RRBTWFLT.JNP
RRBTWFLT.LG
RRBTWFLT.SNO



Storage column

300(w) x 1450(h) x 260(d)mm

Reversible column with door overlap for opening. Additional handles can be purchased and used to match your main furniture piece.

£540.00

RRCOL14.GW
RRCOL14.MW
RRCOL14.DB
RRCOL14.MCB
RRCOL14.JNP
RRCOL14.LG
RRCOL14.SNO

OPTIONAL BASIN OVERFLOW CAPS



| | | |
|----------------|--------|--------|
| Black | OVMCBK | £11.30 |
| Brushed brass | OVMCA | £11.30 |
| Gunmetal | OVMCGM | £11.30 |
| Brushed nickel | OVMCBN | £11.30 |
| Brushed bronze | OVMCBZ | £11.30 |

OVERFLOW CAPS - ISOCAST

24mm white overflow cap

For use with Isocast basins & any non chrome tap

OVI24WT £11.30

Colour matched illuminated cabinets

Choose your cabinet finish and size (no sides included)

| | Silver | | Black | | Brushed brass | | Brushed bronze | |
|----------|--------|---------|-----------|---------|---------------|---------|----------------|---------|
| Size | Code | RRP | Code | RRP | Code | RRP | Code | RRP |
| 500x700 | VTC050 | £565.00 | VTC050-BL | £675.00 | VTC050-BR | £675.00 | VTC050-BZ | £675.00 |
| 650x700 | VTC065 | £675.00 | VTC065-BL | £775.00 | VTC065-BR | £775.00 | VTC065-BZ | £775.00 |
| 800x700 | VTC080 | £775.00 | VTC080-BL | £885.00 | VTC080-BR | £885.00 | VTC080-BZ | £885.00 |
| 1000x700 | VTC100 | £885.00 | VTC100-BL | £995.00 | VTC100-BR | £995.00 | VTC100-BZ | £995.00 |

Choose your colour matched sides

| Finish | Code | RRP |
|------------------|-------------|---------|
| Gloss white | RRC-CSK.W | £107.50 |
| Matt white | RRC-CSK.MW | £107.50 |
| Derwent blue | RRC-CSK.DB | £107.50 |
| Matt carbon | RRC-CSK.MCB | £107.50 |
| Juniper green | RRC-CSK.JNP | £107.50 |
| Gloss light grey | RRC-CSK.LG | £107.50 |
| Sand oak | RRC-CSK.SNO | £107.50 |



PAGE 328

SCHEME BASINS & WORKTOPS

COUNTER TOP

Use our counter top basins in conjunction with a solid surface worktop

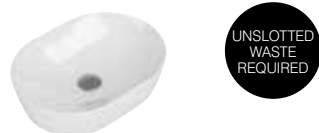

UNSLOTTED WASTE REQUIRED

Pill counter top basin
490(w) x 130(h) x 360(d)mm

Basin DC12051 **£161.00**



UNSLOTTED WASTE REQUIRED

Round counter top basin - Black
355(w) x 120(h) x 360(d)mm

Basin DC12050 **£214.00**



UNSLOTTED WASTE REQUIRED

Fluted counter top basin
355(w) x 120(h) x 355(d)mm

Basin DC12054 **£161.00**

CERAMIC - SCHEME



Scheme 450 ceramic basin
465(w) x 60(h) x 290(d)mm

1 tap hole ESB45 **£220.50**

CERAMIC - FRAME



Frame 600 ceramic basin
610(w) x 80(h) x 400(d)mm

1 tap hole FRM600C **£405.00**



Frame 800 ceramic basin
810(w) x 80(h) x 400(d)mm

1 tap hole FRM800C **£560.00**

COUNTER TOP

Use our counter top basins in conjunction with a solid surface worktop



UNSLOTTED WASTE REQUIRED

Square counter top basin
400(w) x 150(h) x 400(d)mm

Basin DC12052 **£161.00**



UNSLOTTED WASTE REQUIRED

Rectangular counter top basin
450(w) x 135(h) x 325(d)mm

Basin DC12053 **£161.00**



UNSLOTTED WASTE REQUIRED

Round counter top basin - White
355(w) x 120(h) x 360(d)mm

Basin DC12049 **£134.00**



SLOTTED WASTE REQUIRED

Bowl counter top basin
380(w) x 155(h) x 380(d)mm

Basin DC12048 **£118.00**

ISOCAST



600 Isocast basin
overflow kit supplied
605(w) x 35(h) x 395(d)mm

1 tap hole SCH600IS **£320.00**



800 Isocast basin
overflow kit supplied
805(w) x 35(h) x 395(d)mm

1 tap hole SCH800IS **£366.00**

ARCTIC WHITE WORKTOPS



SOLID SURFACE WORKTOPS WITH SUPPORTS

For use with wall mounted units and any counter top basin
Undrilled to allow bespoke placement of basin and tap

602(w) x 392(d) x 12mm(h)
SCH6SSWKIT **£214.00**

802(w) x 392(d) x 12mm(h)
SCH8SSWKIT **£268.00**

1202(w) x 392(d) x 12mm(h)
SCH12SSWKIT **£375.00**

BIANCO MARBLE WORKTOPS



SOLID SURFACE WORKTOPS WITH SUPPORTS

For use with wall mounted units and any counter top basin
Undrilled to allow bespoke placement of basin and tap

602(w) x 392(d) x 12mm(h)
SCH6SSBMKIT **£214.00**

802(w) x 392(d) x 12mm(h)
SCH8SSBMKIT **£268.00**

1202(w) x 392(d) x 12mm(h)
SCH12SSBMKIT **£375.00**



1200 DOUBLE UNIT LOOK

The flexibility of our Scheme furniture range allows for the pairing of 2 x 600mm units with a bianco marble or arctic white worktop to create a 1200mm unit. This can then be used with one or two countertop basins.

Simply order x2 scheme units (fluted or slab) and pair with the relevant worktop and support kit below

Worktop kits to create a 1200mm unit

1200 double worktop & supports Arctic White SCH12SSWDBL **£375.00**

1200 double worktop & supports Bianco Marble SCH12SSBMDL **£375.00**

1202(w) x 392(d) x 12mm(h)



FLUTED PENDANT LIGHTING
Other finishes and styles available. See page 296

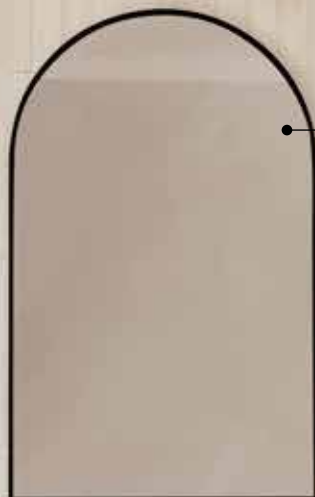

THISIS ARCH MIRROR
Other finishes and shapes available see page 320



1200 WORKTOP
Other finishes available. See page 88



SAND OAK 2X 600 FLUTED UNITS
Other finishes available see page 87



SYSTEM

Cool yet elegantly styled, System offers complete flexibility to tailor your space



Gloss white



Matt derwent blue



Gloss light grey



Matt carbon



Matt juniper green



Sand oak





Unique Furniture

SYSTEM

10
YEAR

GUARANTEE
for all System
furniture units

System is a flexible range of furniture with a wealth of possibilities; every detail can be tweaked to perfectly suit your space & style. With its softly rounded corners & smooth lines, System will turn the daily routine into a pleasurable experience. With a wide selection of unit sizes, basins, stunning furniture finishes & handle options, this is modern design at its best.

Guaranteed for 10 years, our furniture reflects our promise of enduring quality and craftsmanship.

- Smooth, curved unit design
- Your choice of finish, basin and handles to personalise your unit
- Coordinating cabinets available



TOP RIGHT
500mm wall
mounted basin
unit in gloss light
grey with isocast
basin

BOTTOM RIGHT
Rectangular
countertop basin
detail

LEFT
800mm wall mounted
basin unit in sand oak
with pill countertop
basin





THEISIS 800 MIRROR
Other sizes and shapes
available see page 320

STORM NOVA BASIN MIXER
Other finishes and styles available
see pages 184-187

ARUBA WALL HUNG PAN &
SOFT CLOSE SEAT
Other styles and seats
available see page 156

JUNIPER GREEN
800 UNIT & CERAMIC BASIN
Other finishes and finishes
available see page 96

Unique Furniture

SYSTEM - BASIN OPTIONS

The polished, minimal form of our basin designs work perfectly when combined with System furniture. Choose from sleek, single-mould isocast or classic ceramic in a range of sizes to suit your System basin unit. Or go bold with one of our stylish countertop basin options, for a truly unique look.

- Smooth, ceramic System basins designed to perfectly match your furniture
- Isocast basins inspired by high end premium hotels provide a slimmer look and useful extra surface space in the bathroom
- Countertop basins make a statement to create a true centrepiece in the bathroom



TOP RIGHT
500mm unit in gloss light grey with square countertop basin

BOTTOM RIGHT
800mm basin unit in derwent blue with isocast basin

LEFT
600mm basin unit in matt carbon with ceramic basin



THESIS ARCH MIRROR
Other sizes and shapes
available see page 320



COUNTERTOP BASIN
& WORKTOP
Other finishes and styles
available, see page 97



SAND OAK 600 UNIT
Other finishes and finishes
available see page 96

SYSTEM UNITS & HANDLES



450 freestanding basin unit
445(w) x 810(h) x 285(d)mm
£314.00



500 wall mounted basin unit with double drawer
485(w) x 500(h) x 410(d)mm
£775.00



600 wall mounted basin unit with double drawer
585(w) x 500(h) x 410(d)mm
£800.00



800 wall mounted basin unit with double drawer
785(w) x 500(h) x 410(d)mm
£885.00

| | | | | |
|-------------------------|-----------|-------------|-------------|-------------|
| Gloss white | SYS4F.GW | SYS500D.GW | SYS600D.GW | SYS800D.GW |
| Derwent blue | SYS4F.DB | SYS500D.DB | SYS600D.DB | SYS800D.DB |
| Gloss light grey | SYS4F.LG | SYS500D.LG | SYS600D.LG | SYS800D.LG |
| Matt carbon | SYS4F.MCB | SYS500D.MCB | SYS600D.MCB | SYS800D.MCB |
| Juniper green | SYS4F.JNP | SYS500D.JNP | SYS600D.JNP | SYS800D.JNP |
| Sand oak | SYS4F.SNO | SYS500D.SNO | SYS600D.SNO | SYS800D.SNO |

SYSTEM HANDLE OPTIONS

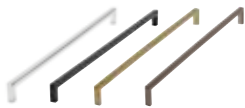

Stockton handles

| | | |
|-----------------------|--------------|---------------|
| Chrome | | |
| 128mm centres | SCHH04C.128 | £23.30 |
| 320mm centres | SCHH04C.320 | £30.10 |
| 492mm centres* | SCHH04C.492 | £48.60 |
| Matt black | | |
| 128mm centres | SCHH04B.128 | £23.30 |
| 320mm centres | SCHH04B.320 | £30.10 |
| 492mm centres* | SCHH04B.492 | £48.60 |
| Brass | | |
| 128mm centres | SCHH04A.128 | £23.30 |
| 320mm centres | SCHH04A.320 | £30.10 |
| 492mm centres* | SCHH04A.492 | £48.60 |
| Brushed nickel | | |
| 128mm centres | SCHH04BN.128 | £23.30 |
| 320mm centres | SCHH04BN.320 | £30.10 |
| 492mm centres* | SCHH04BN.492 | £48.60 |



Scheme handle no.8

| | | |
|----------------|-------------|---------------|
| Chrome | | |
| 128mm centres | SCHH08C.128 | £32.10 |
| 224mm centres* | SCHH08C.224 | £56.00 |



Sedona handles

| | | |
|-----------------|--------------|---------------|
| Chrome | | |
| 160mm centres | SCHH02C.160 | £29.10 |
| 256mm centres | SCHH02C.256 | £48.00 |
| 384mm centres | SCHH02C.384 | £59.60 |
| Black | | |
| 160mm centres | SCHH02B.160 | £29.10 |
| 256mm centres | SCHH02B.256 | £48.00 |
| 384mm centres | SCHH02B.384 | £59.60 |
| Gunmetal | | |
| 160mm centres | SCHH02GM.160 | £29.10 |

FOR ALTERNATIVE HANDLE OPTIONS SEE PAGE 112



Catalina colour matched handles

| | | |
|---------------------|---------------|---------------|
| 150mm length | | |
| ○ White | SCHH09W.150 | £22.70 |
| ● Derwent Blue | SCHH09DB.150 | £22.70 |
| ● Light Grey | SCHH09LG.150 | £22.70 |
| ● Carbon | SCHH09MCB.150 | £22.70 |
| ● Juniper Green | SCHH09JNP.150 | £22.70 |
| ● Black | SCHH09BK.150 | £22.70 |
| ● Chrome | SCHH09C.150 | £22.70 |
| ● Brushed brass | SCHH09A.150 | £22.70 |

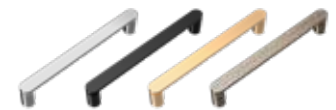

Monterey handles

| | | |
|----------------------|--------------|---------------|
| Chrome | | |
| 160mm centres | FHMON.C.160 | £29.10 |
| Black | | |
| 160mm centres | FHMON.B.160 | £29.10 |
| Brushed brass | | |
| 160mm centres | FHMON.A.160 | £29.10 |
| Gunmetal | | |
| 160mm centres | FHMON.BN.160 | £29.10 |

* Not suitable for 450mm units

SYSTEM FINISH OPTIONS



Gloss white



Matt derwent blue



Gloss light grey



Matt carbon



Matt juniper green



Sand oak

CERAMIC



450 ceramic basin
465(w) x 50(h) x 295(d)mm

1 tap hole SYS400C £220.50



600 ceramic basin
600(w) x 80(h) x 420(d)mm

1 tap hole SYS600C £399.00



800 ceramic basin
800(w) x 80(h) x 420(d)mm

1 tap hole SYS800C £555.00

ISOCAST



500 isocast basin
500(w) x 35(h) x 420(d)mm

1 tap hole SYS500IS £275.00



600 isocast basin
600(w) x 35(h) x 420(d)mm

1 tap hole SYS600IS £321.00



800 isocast basin
800(w) x 35(h) x 420(d)mm

1 tap hole SYS800IS £367.00

OPTIONAL BASIN OVERFLOW CAPS



| | | |
|----------------|--------|--------|
| Black | OVMCBK | £11.30 |
| Brushed brass | OVMCA | £11.30 |
| Gunmetal | OVMCGM | £11.30 |
| Brushed nickel | OVMCBN | £11.30 |
| Brushed bronze | OVMCBZ | £11.30 |

OVERFLOW CAPS - ISOCAST

24mm white overflow cap

For use with Isocast basins & any non chrome tap

OVI24WT £11.30

COUNTER TOP

Use our counter top basins in conjunction with a solid surface worktop



UNSLOTTED WASTE REQUIRED

Pill counter top basin
490(w) x 130(h) x 360(d)mm

Basin DC12051 £161.00



UNSLOTTED WASTE REQUIRED

Round counter top basin - Black
355(w) x 120(h) x 360(d)mm

Basin DC12050 £214.00



UNSLOTTED WASTE REQUIRED

Fluted counter top basin
355(w) x 120(h) x 355(d)mm

Basin DC12054 £161.00

ARCTIC WHITE WORKTOPS



SOLID SURFACE WORKTOPS WITH SUPPORTS

For use with wall mounted units and any counter top basin
Undrilled to allow bespoke placement of basin and tap

496(w) x 415(d) x 12mm(h)

SYS5SSWKIT £187.50

594(w) x 415(d) x 12mm(h)

SYS6SSWKIT £214.00

794(w) x 415(d) x 12mm(h)

SYS8SSWKIT £268.00

COUNTER TOP

Use our counter top basins in conjunction with a solid surface worktop

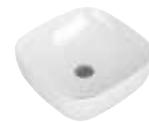

UNSLOTTED WASTE REQUIRED

Square counter top basin
400(w) x 150(h) x 400(d)mm

Basin DC12052 £161.00



UNSLOTTED WASTE REQUIRED

Rectangular counter top basin
450(w) x 135(h) x 325(d)mm

Basin DC12053 £161.00



UNSLOTTED WASTE REQUIRED

Round counter top basin - White
355(w) x 120(h) x 360(d)mm

Basin DC12049 £134.00



SLOTTED WASTE REQUIRED

Bowl counter top basin
380(w) x 155(h) x 380(d)mm

Basin DC12048 £118.00

BIANCO MARBLE WORKTOPS



SOLID SURFACE WORKTOPS WITH SUPPORTS

For use with wall mounted units and any counter top basin
Undrilled to allow bespoke placement of basin and tap

496(w) x 415(d) x 12mm(h)

SYS5SSBMKIT £187.50

594(w) x 415(d) x 12mm(h)

SYS6SSBMKIT £214.00

794(w) x 415(d) x 12mm(h)

SYS8SSBMKIT £268.00



Back to wall WC unit & worktop
570(w) x 860(h) x 235mm(d)

£401.00

| | |
|------------------|--------------|
| Gloss white | RRBTWFLT.W |
| Derwent blue | RRBTWFLT.DB |
| Gloss light grey | RRBTWFLT.LG |
| Matt carbon | RRBTWFLT.MCB |
| Juniper green | RRBTWFLT.JNP |
| Sand oak | RRBTWFLT.SNO |



Storage column
300(w) x 1450(h) x 260(d)mm

£540.00

| |
|-------------|
| RRCOL14.GW |
| RRCOL14.DB |
| RRCOL14.LG |
| RRCOL14.MCB |
| RRCOL14.JNP |
| RRCOL14.SNO |

Reversible column with door overlap for opening. Additional handles can be purchased and used to match your main furniture piece.



Beech storage boxes (set of 2)

Add to the practicality of your Scheme furniture units with a set of 2 beech boxes with lids to keep all your bathroom bits and bobs together inside the main drawer.

Small box
100(w) x 55(h) x 270mm(d)
Large box
200(w) x 55(h) x 270mm(d)

BOXSET19 £146.00

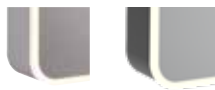

PAGE 334

System illuminated cabinets

Adjustable LED warmth & brightness
Heated demister pad
Infrared on/off sensor to operate lighting & demister pad
IP44 rated

Silver sides

| | | |
|-----------------------------------|--------|-----------|
| 700(h) x 500(w) x 140(d)mm single | SYC050 | £785.00 |
| 700(h) x 600(w) x 140(d)mm double | SYC060 | £980.00 |
| 700(h) 1000(w) x 140(d)mm double | SYC100 | £1,160.00 |

Black sides

| | | |
|-----------------------------------|-----------|---------|
| 700(h) x 500(w) x 140(d)mm single | SYC050-BL | £785.00 |
| 700(h) x 600(w) x 140(d)mm double | SYC060-BL | £980.00 |

CABINETS

System illuminated cabinets

Choose your cabinet finish and size (no sides included). Choose your side panels from the list below

| Size | Silver | | Black | | Brushed brass | | Brushed bronze | |
|----------|--------|---------|-----------|---------|---------------|---------|----------------|---------|
| | Code | RRP | Code | RRP | Code | RRP | Code | RRP |
| 500x700 | VTC050 | £565.00 | VTC050-BL | £675.00 | VTC050-BR | £675.00 | VTC050-BZ | £675.00 |
| 650x700 | VTC065 | £675.00 | VTC065-BL | £775.00 | VTC065-BR | £775.00 | VTC065-BZ | £775.00 |
| 800x700 | VTC080 | £775.00 | VTC080-BL | £885.00 | VTC080-BR | £885.00 | VTC080-BZ | £885.00 |
| 1000x700 | VTC100 | £885.00 | VTC100-BL | £995.00 | VTC100-BR | £995.00 | VTC100-BZ | £995.00 |

Order cabinet above and sides kit below

| Finish | Code | RRP |
|------------------|-------------|---------|
| Gloss white | RRC-CSK.W | £107.50 |
| Derwent blue | RRC-CSK.DB | £107.50 |
| Gloss light grey | RRC-CSK.LG | £107.50 |
| Matt carbon | RRC-CSK.MCB | £107.50 |
| Juniper green | RRC-CSK.JNP | £107.50 |
| Sand oak | RRC-CSK.SNO | £107.50 |



PAGE 328



SYSTEM FINISH OPTIONS



Gloss white



Matt derwent blue



Gloss light grey



Matt carbon



Matt juniper green



Sand oak



THESIS MIRROR
Other sizes available.
See page 320



STORM NOVA BASIN MIXER
Other styles & finishes available.
See pages 184-187



SYSTEM CLOAKROOM UNIT
Other sizes & finishes available.
See page 96

ACADEMY

If you need lots of storage then this contemporary free standing range is perfect for you.



Gloss white



Matt derwent blue



Gloss agave





Modern Furniture

ACADEMY

10
YEAR

GUARANTEE
for all Academy
furniture units

Combine contemporary styling with storage solutions for your bathroom. With its practical ceramic basin offering a generous wash area, this freestanding range allows you to maximise storage space. A variety of handle choices allows you to add your own style.

Guaranteed for 10 years, our furniture reflects our promise of enduring quality and craftsmanship.

- Expansive storage across three sizes
- Choose from our range of handles to customise your unit. See page 112 for all compatible handles



TOP RIGHT
800mm basin unit
in derwent blue

BOTTOM RIGHT
1000mm basin unit
in gloss white

LEFT
600mm basin unit
in agave gloss



ACADEMY UNITS, BASINS & AUXILIARY



600 freestanding basin unit
585(w) x 780(h) x 415(d)mm
£715.00



800 freestanding basin unit
785(w) x 780(h) x 415(d)mm
£830.00



1000 freestanding basin unit
985(w) x 780(h) x 415(d)mm
£1,120.00



Storage column
300(w) x 1450(h) x 260(d)mm
£540.00

Gloss white
Derwent blue
Agave gloss

ACY6F.W

ACY6F.DB

ACY6F.AGG

ACY8F.W

ACY8F.DB

ACY8F.AGG

ACY10F.W

ACY10F.DB

ACY10F.AGG

RRCOL14.GW

RRCOL14.DB

* Reversible column with door overlap for opening. Additional handles can be purchased and used to match your main furniture piece.

600 ceramic basin
600(w) x 80(h) x 465(d)mm

ACY600C **£398.00**

800 ceramic basin
800(w) x 80(h) x 465(d)mm

ACY800C **£496.00**

1000 ceramic basin
1000(w) x 80(h) x 465(d)mm

ACY1000C **£570.00**



Back to wall WC unit & worktop
570(w) x 860(h) x 235mm(d)

£401.00

Gloss white
Derwent blue
Agave gloss

RRBTWFLT.W

RRBTWFLT.DB

RRBTWFLT.AGG

OPTIONAL BASIN OVERFLOW CAPS



| | | |
|----------------|--------|--------|
| Black | OVMCBK | £11.30 |
| Brushed brass | OVMCA | £11.30 |
| Gunmetal | OVMCGM | £11.30 |
| Brushed nickel | OVMCBN | £11.30 |
| Brushed bronze | OVMCBZ | £11.30 |

HANDLE OPTIONS

The cost of all handles is included in the furniture price, see below for quantity details for each unit size

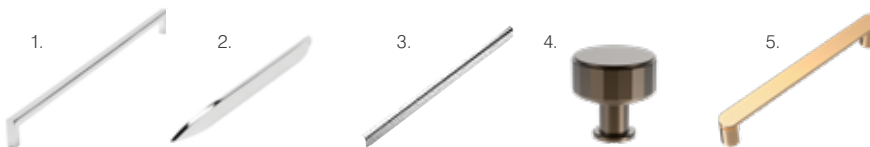

SEE PAGE 112 FOR ALL COMPATIBLE HANDLES

| Unit | Qty | 1. Pull handle | | | 2. Front mounted curved handle | 3. Drawer top handle |
|-----------|----------|----------------|-------------|-------------|--------------------------------|---|
| | | Chrome | Black | Brass | Chrome | Chrome |
| 600 unit | 2 | SCHH04C.320 | SCHH04B.320 | SCHH04A.320 | SCHH08C.128 | SCHH09C.579 |
| 800 unit | 2 | SCHH04C.492 | SCHH04B.492 | SCHH04A.492 | SCHH08C.224 | SCHH09C.779 |
| 1000 unit | 2 door | SCHH04C.128 | SCHH04B.128 | SCHH04A.128 | | SCHH09LC.216 (left) SCHH09RC.216 (right) |
| | 2 drawer | SCHH04C.320 | SCHH04B.320 | SCHH04A.320 | | SCHH09C.537 |

| Unit | Qty | 4. Fairfax knob | | | | 5. Monterey pull handle | | |
|-----------|----------|-----------------|---------|---------|----------|-------------------------|-------------|-------------|
| | | Chrome | Black | Brass | Bronze | Chrome | Black | Brass |
| 600 unit | 2 | FHFAX.C | FHFAX.B | FHFAX.A | FHFAX.BR | FHMON.C.160 | FHMON.B.160 | FHMON.A.160 |
| 800 unit | 2 | FHFAX.C | FHFAX.B | FHFAX.A | FHFAX.BR | FHMON.C.160 | FHMON.B.160 | FHMON.A.160 |
| 1000 unit | 2 door | FHFAX.C | FHFAX.B | FHFAX.A | FHFAX.BR | | | |
| | 2 drawer | FHFAX.C | FHFAX.B | FHFAX.A | FHFAX.BR | | | |

CLOAKROOMS

Compact yet functional, we prove that small can be beautiful





Timeless Furniture
HAMPTON



GUARANTEE
for all cloakroom
furniture units

Our signature timeless design, in a compact form to bring style into any cloakroom.

- Your choice of handle. Elegant chrome knob supplied as standard.
- Left or right hinged door for full flexibility
- Available in six, heritage inspired finishes



Matt chalk white



Matt agave



Matt mocha



Matt slate grey



Matt sage grey



Matt black



HANDLE
OPTIONS.
PAGE 112

RIGHT
Hampton cloakroom
unit in matt mocha

LEFT
Hampton cloakroom
unit handle detail

THEESIS PILL MIRROR
For other sizes, styles or finishes see page 320



KESWICK
BASIN MIXER
Other styles available,
see pages 196-199



HAMPTON
SANITARYWARE
Other styles and seat options
available see page 148



SAGE GREEN
HAMPTON
CLOAKROOM UNIT
Other finishes available,
see page 110

Unique Furniture

ESTA

10
YEAR

GUARANTEE
for all cloakroom
furniture units

Compact and beautifully designed, with a wide range of style options to perfectly suit your bathroom project

- A selection of six, on-trend finishes
- Your choice of handle. See page 112
- Available in freestanding and wall hung styles



TOP RIGHT
Esta freestanding unit
in matt carbon

BOTTOM RIGHT
Esta wall mounted
unit in gloss white

LEFT
Esta wall mounted
unit in juniper green

Unique Furniture

SYSTEM

10
YEAR

GUARANTEE
for all cloakroom
furniture units

Cool yet elegantly styled, System offers softly rounded corners and smooth lines to suit any compact space and style.

- Your choice of six stylish finishes
- Make yours unique with your choice of handle. See page 112
- Coordinating mirrors and cabinets available



Gloss white



Derwent blue



Matt carbon



Juniper green



Gloss light grey



Sand oak



TOP RIGHT
System cloakroom
unit in juniper green

BOTTOM RIGHT
System cloakroom
unit in gloss light grey

LEFT
System cloakroom
unit in derwent blue



CLOAKROOM UNITS



Esta
450 wall mounted basin unit
445(w) x 575(h) x 280(d)mm
£337.00

- Gloss white
- Derwent blue
- Gloss light grey
- Matt carbon
- Juniper green
- Sand oak

- ESWM45W
- -
- ESWM45LG
- -
- -
- -

450 ceramic basin
465(w) x 60(h) x 290(d)mm
ESB45 £220.50



Esta
450 freestanding basin unit
445(w) x 820(h) x 280(d)mm
£374.00

- ESVB45W
- ESVB45DB
- ESVB45LG
- ESVB45MCB
- ESVB45JNP
- ESVB45SNO

450 ceramic basin
465(w) x 60(h) x 290(d)mm
ESB45 £220.50



System
450 freestanding basin unit
445(w) x 810(h) x 285(d)mm
£314.00

- SYS4F.GW
- SYS4F.DB
- SYS4F.LG
- SYS4F.MCB
- SYS4F.JNP
- SYS4F.SNO

450 ceramic basin
465(w) x 50(h) x 290(d)mm
SYS400C £220.50

OPTIONAL BASIN OVERFLOW CAPS

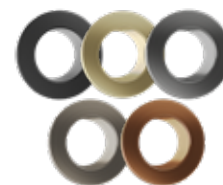

OVERFLOW CAPS - CERAMIC
Can only be used on Esta/System

| | |
|-----------------------|--------|
| Black | |
| OVMCBK | £11.30 |
| Brushed brass | |
| OVMCA | £11.30 |
| Gunmetal | |
| OVMCGM | £11.30 |
| Brushed nickel | |
| OVMCBN | £11.30 |
| Brushed bronze | |
| OVMCBZ | £11.30 |



Hampton
400 freestanding basin unit
410(w) x 730(h) x 350(d)mm
£468.00

- Matt chalk white
- Matt agave
- Matt mocha
- Matt slate grey
- Matt sage green
- Matt black

- HAM450B.W
- HAM450B.AG
- HAM450B.MC
- HAM450B.SG
- HAM450B.SGN
- HAM450B.BLK

420 ceramic basin
420(w) x 130(h) x 360(d)mm
HAM450C £167.00





Adding the finishing touches



GUARANTEE

HANDLE OPTIONS

We have a comprehensive offer of handles & door knobs to complement our furniture.

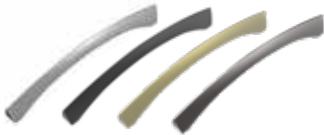

Sedona Pull Chrome

186mm(l) SCHH02C.160 £29.10

Sedona Pull Black

186mm(l) SCHH02B.160 £29.10

Sedona Pull Brushed Brass

186mm(l) SCHH02A.160 £29.10

Sedona Pull Gunmetal

186mm(l) SCHH02GM.160 £29.10



Monterey Pull Chrome

175mm(l) FHMON.C.160 £29.10

Monterey Pull Black

175mm(l) FHMON.B.160 £29.10

Monterey Pull Brushed Brass

175mm(l) FHMON.A.160 £29.10

Monterey Pull Brushed Nickel

175mm(l) FHMON.BN.160 £29.10



Tacoma Pull Chrome

170mm(l) FHTAC.C.160 £29.10

Tacoma Pull Black

170mm(l) FHTAC.B.160 £29.10

Tacoma Pull Brushed Brass

170mm(l) FHTAC.A.160 £29.10

Tacoma Pull Brushed Nickel

170mm(l) FHTAC.BN.160 £29.10



Montana Chrome

110mm(l) FHMON.C £12.10

Montana Black

110mm(l) FHMON.B £12.10



Fresno Pull Chrome

196mm(l) FHFREHAN.C.160 £73.80

Fresno Pull Black

196mm(l) FHFREHAN.B.160 £73.80

Fresno Pull Brushed Brass

196mm(l) FHFREHAN.A.160 £73.80



Fresno Pull Antique Bronze

196mm(l) FHFREHAN.BR.160 £73.80

Fresno Brushed Bronze

196mm(l) FHFREHAN.BZ.160 £73.80

Fresno Pull Brushed Nickel

196mm(l) FHFREHAN.BN.160 £73.80



Toledo Pull Handle Chrome

178mm(l) FHTOL-C-160 £46.70

Toledo Pull Handle Black

178mm(l) FHTOL-B-160 £46.70

Toledo Pull Handle Brushed Brass

178mm(l) FHTOL-A-160 £46.70



Toledo Pull Handle Brushed Bronze

178mm(l) FHTOL-BZ-160 £46.70

Toledo Pull Handle Brushed Nickel

178mm(l) FHTOL-BN-160 £46.70



Stockton Chrome

Available in 3 sizes

128mm(l) SCHH04C.128 £23.30

320mm(l) SCHH04C.320 £30.10

492mm(l) SCHH04C.492 £48.60



Stockton Black

Available in 3 sizes

128mm(l) SCHH04B.128 £23.30

320mm(l) SCHH04B.320 £30.10

492mm(l) SCHH04B.492 £48.60



Stockton Brushed Brass

Available in 3 sizes

128mm(l) SCHH04A.128 £23.30

320mm(l) SCHH04A.320 £30.10

492mm(l) SCHH04A.492 £48.60



Stockton Brushed Nickel

Available in 3 sizes

128mm(l) SCHH04BN.128 £23.30

320mm(l) SCHH04BN.320 £30.10

492mm(l) SCHH04BN.492 £48.60



Walcot Pull Handle Chrome

184mm(l) FHWA-C-160 £55.00

Walcot Pull Handle Brass

184mm(l) FHWA-A-160 £55.00

Walcot Pull Handle Black

184mm(l) FHWA-B-160 £55.00



Walcot Pull Handle Antique Bronze

184mm(l) FHWA-BR-160 £55.00

Walcot Pull Handle Brushed Bronze

184mm(l) FHWA-BZ-160 £55.00

Walcot Pull Handle Brushed Nickel

184mm(l) FHWA-BN-160 £55.00



Columbus Chrome

174mm(l) FHCOL.C £29.70



Madison Chrome

171mm(l) FHMAD.C £29.70



Hudson Chrome

29mm(dia) FHHUD.C £29.10

Hudson Black

29mm(dia) FHHUD.B £29.10

Hudson Brushed Brass

29mm(dia) FHHUD.A £29.10



Hudson Brushed Bronze

29mm(dia) FHHUD.BZ £29.10

Hudson Brushed Nickel

29mm(dia) FHHUD.BN £29.10



Berkeley Chrome

34mm(dia) FHBER.C £36.40

Berkeley Black

34mm(dia) FHBER.B £36.40

Berkeley Brushed Brass

34mm(dia) FHBER.A £36.40



Westport Chrome

33mm(dia) FHWST.C £29.10

Westport Black

33mm(dia) FHWST.B £29.10

Westport Brushed Brass

33mm(dia) FHWST.A £29.10



Toledo Chrome

FHTOLHAN.C £29.10

Toledo Black

FHTOLHAN.B £29.10

Toledo Untreated Brass

FHTOLHAN.A £29.10



Toledo Brushed Bronze

FHTOLHAN.BZ £29.10

Toledo Brushed Nickel

FHTOLHAN.BN £29.10

Our brass Toledo t-bar features a living finish that develops subtle color variations over time, enhancing their character. A metal polish can restore the original look. To prevent wood corrosion and discoloration, remove handles from the vanity before treatment.



Fairfax Chrome

29mm(dia) FHFAX.C £35.60

Fairfax Black

29mm(dia) FHFAX.B £35.60

Fairfax Brushed Brass

29mm(dia) FHFAX.A £35.60



Fairfax Antique Bronze

29mm(dia) FHFAX.BR £35.60

Fairfax Brushed Bronze

29mm(dia) FHFAX.BZ £35.60

Fairfax Brushed Nickel

29mm(dia) FHFAX.BN £35.60



Fresno Chrome

35mm(dia) FHFRE.C £35.60

Fresno Black

35mm(dia) FHFRE.B £35.60

Fresno Antique Bronze

35mm(dia) FHFRE.BZ £35.60



Fresno Brushed Brass

35mm(dia) FHFRE.A £35.60

Fresno Brushed Bronze

35mm(dia) FHFRE.BR £35.60

Fresno Brushed Nickel

35mm(dia) FHFRE.BN £35.60



Washington Chrome

32mm(dia) FHWAS.C £12.40

Washington Brushed Brass

32mm(dia) FHWAS.A £12.40



Washington Black

32mm(dia) FHWAS.B £12.40

Washington Brushed Nickel

32mm(dia) FHWAS.BN £12.40



Walcot Chrome

33mm(dia) FHWA-C-0 £21.80

Walcot Brushed Brass

33mm(dia) FHWA-A-0 £21.80

Walcot Black

33mm(dia) FHWA-B-0 £21.80



Walcot Antique Brushed Bronze

33mm(dia) FHWA-BR-0 £21.80

Walcot Brushed Bronze

33mm(dia) FHWA-BZ-0 £21.80

Walcot Brushed Nickel

33mm(dia) FHWA-BN-0 £21.80



Caldwell Bronze

30mm(dia) FHCAL.BR £21.90



Henderson Chrome

39mm(dia) FHHEN.C £12.40



Reno Chrome

32mm(dia) FHREN.C £23.30



Catalina Colour Matched
Available in 12 colours



- White SCHH09W.150 £22.70
- Derwent Blue SCHH09DB.150 £22.70
- Light Grey SCHH09LG.150 £22.70
- Carbon SCHH09MCB.150 £22.70
- Juniper Green SCHH09JNP.150 £22.70
- Black SCHH09BK.150 £22.70

- Powder Grey SCHH09POW.150 £22.70
- Dusk Blue SCHH09DSK.150 £22.70
- Sage Green SCHH09SGN.150 £22.70
- Coniston Blue SCHH09CB.150 £22.70
- Brushed Brass SCHH09A.150 £22.70
- Burgundy SCHH09BY.150 £22.70

Not compatible with Concierge



FITTED FURNITURE



Explore our fitted furniture

COLLECTION

Fitted bathrooms are custom-designed to make the most efficient use of available space. By utilising every nook and cranny, fitted furniture can provide ample storage and maximise functionality, particularly in smaller bathrooms.

Designed to seamlessly integrate with the overall aesthetic of your bathroom. Fitted furniture offers a cohesive and uniform look, as the units are fitted against walls and often provide concealed storage, hiding pipework and creating a neat appearance.

The furniture is highly customisable to suit your specific needs and preferences. You can select the materials, finishes, and configurations to create a personalised space that perfectly matches your style and requirements.

Roper Rhodes Fitted Furniture

DESIGNED BY US. TAILORED BY YOU.



GUARANTEE
10 year guarantee on
all fitted furniture

Fitted furniture is all about taking the space you have and making it reach its full potential. Unrestricted and completely customisable, fitted furniture gives you the flexibility & storage you need, with the style you love. Fitted furniture is great for going between walls to maximise storage and hide any pipework and services

Whether you live in a Victorian townhouse, an ultra-modern apartment, or something a little more unusual, our boundless combinations of fitted furniture styling options give you the ability to create a bathroom that feels uniquely and effortlessly 'you'.



WIDE CHOICE OF UNITS

Choose from a range of floor units, wall cupboards, full height and above counter units, all available to help create your perfect bathroom look.



IDEAL FOR LARGE & SMALL SPACES

Consider the available space in your bathroom and choose from either standard depth (353mm) or space-saving slim depth (218mm) units.



Fitted furniture collection

ELAN



A timeless furniture design reimagined for the contemporary home, showcasing a sleek, clean-cut shaker frame.



ELAN FINISHES AVAILABLE



Sage Green



Black



Terra



Powder Grey



Juniper Green



Coniston Blue

Fitted furniture collection

ARUBA



Simple, ultra modern slab-fronted furniture featuring seamless joinery in a versatile range of matt and gloss finishes to add depth to your bathroom scheme.



ARUBA FINISHES AVAILABLE



Sage Green



Oxford Oak



Coniston Blue



Juniper Green



Powder Grey



Mussel



Derwent Blue



Gloss Dark Clay



Gloss White

Fitted furniture collection

BURFORD



Elements of traditional carpentry with the advantages of fitted furniture. Clever detailing, ornate hardware, in a range of 11 rich painted finishes lend a luxurious and inviting atmosphere to any space.



BURFORD FINISHES AVAILABLE

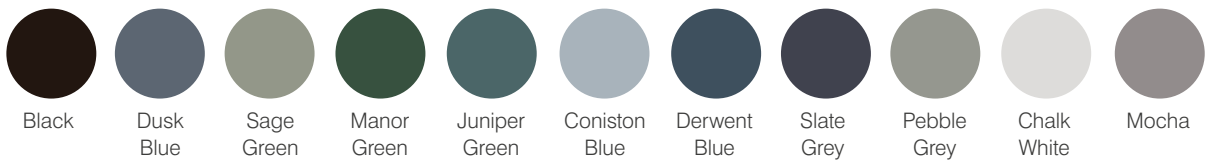



FITTED FURNITURE BROCHURE

Want to know more? Why not ask your local bathroom retailer for a copy of our dedicated fitted furniture book, featuring even more information on all our options and styles. Or if you'd prefer to browse our brochure online, head to our website at

roperrhodes.co.uk/brochures



BATHTUBS



Explore our bathtub

COLLECTION

Our signature bathing collection embodies our legacy of design and time-honoured craftsmanship. Individually produced for quality and consistency, each of our baths marry beauty and utility to elevate the everyday bathing experience. From the quintessential lion foot to sleek, contemporary styles, the bathing collection features era spanning designs to suit any bathroom scheme.

Choose from freestanding tubs, single or doubled-ended styles, showering baths and back-to-wall options for complete design flexibility.

Discover Roper Rhodes Bathtubs

DESIGNED IN THE HOME OF BATHING



CONTEMPORARY BATHTUBS

Sleek, simple and streamlined, our collection of modern baths are ideal for the contemporary family bathroom. Available in a range of sizes, the bathing collection features oval, curved and square bath styles to suit a wide range of tastes. Pair with our wide selection of modern brassware and bath accessory styles.



TRADITIONAL BATHTUBS

Step back in time with our striking collection of traditional freestanding baths. Our range includes styles from the classic clawfoot to the mid-century boat bath in a wide range of sizes to suit bathrooms both small and spacious. With a choice of proprietary traditional accessories available to complete the look.

10 YEAR GUARANTEE

We believe good design stands the test of time. Our bathtubs are all guaranteed for ten years, giving you peace of mind now and for the future.



QUALITY PRODUCTS

Purposeful design is evident in everything we do. Individually made and stringently tested, each bath and bathing accessory in our collection represents the highest levels of quality and forty years of design expertise.



A CLOSER LOOK

All Roper Rhodes baths are built with a dual skinned acrylic body and reinforced with multiple layers of resin fibre to provide superior strength and heat retention.

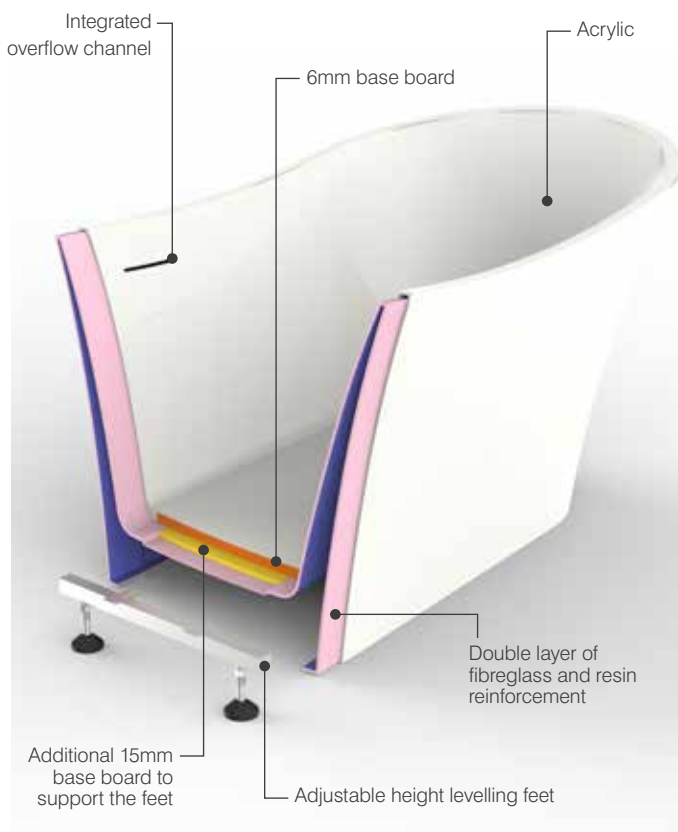

BATHTUB MATERIALS

Our acrylic tubs offer several additional benefits. The double layer of acrylic and the middle reinforcement layer provide better insulation, ensuring water stays warm for longer. More robust and long-lasting, dual layered baths are resistant to flexing and deforming under pressure. A smoother, glossier finish allows for ease of cleaning, while a deeper pigment and improved colour consistency prevent discolouration over time.

PARADIGM

Single Slipper Bathtub

BAC107 1650 x 725 x 735mm £1,670.00



Material

Reinforced Acrylic

Bathtub Weight (unfilled)

39KG

Capacity

250L

Finish

Gloss White

Features:

- Integrated Overflow Channel
- Adjustable Height Levelling Feet
- Single Ended

Compatible Tap Types:

- Freestanding Bath Shower Mixer
- Freestanding Bath Filler
- Wall Mounted Bath Filler

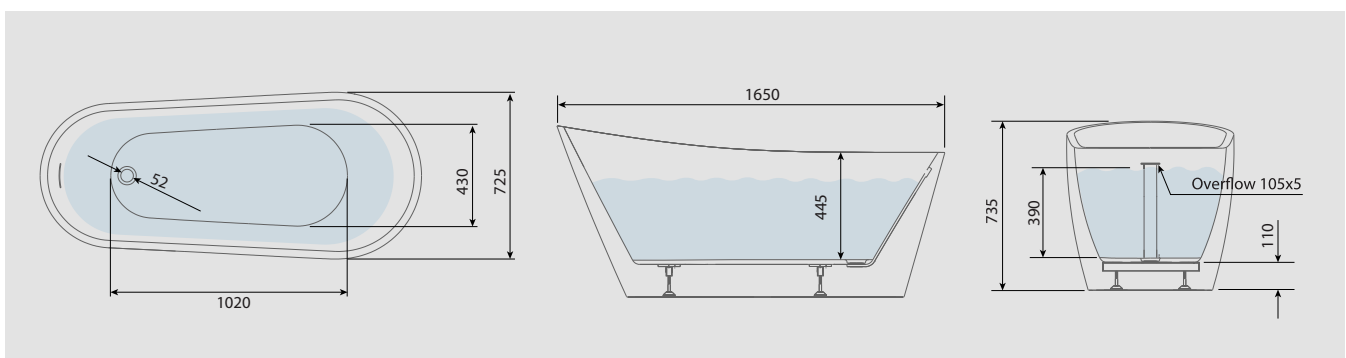

Don't forget to complete your bathtub by choosing your click waste, see page 132

PARADIGM

Double Slipper Bathtub

BAC106 1740 x 760 x 710mm

£1,710.00

10
YEAR

apex

GUARANTEE



Material

Reinforced 3.2mm Acrylic

Bathtub Weight (unfilled)

41KG

Capacity

197L

Finish

Gloss White

Features:

- Integrated Overflow Channel
- Adjustable Height Levelling Feet
- Double Ended

Compatible Tap Types:

- Freestanding Bath Shower Mixer
- Freestanding Bath Filler
- Wall Mounted Bath Filler

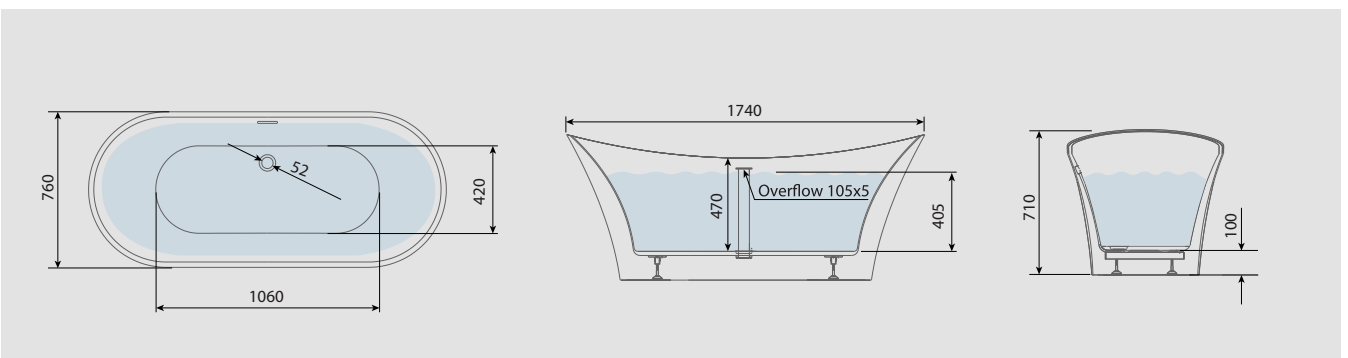

Don't forget to complete your bathtub by choosing your click waste, see page 132



NOTE

Freestanding Bathtubs

| | | |
|---------------|--------------------|------------------|
| BAC101 | 1500 x 750 x 590mm | £1,610.00 |
| BAC102 | 1600 x 750 x 590mm | £1,670.00 |
| BAC103 | 1700 x 800 x 590mm | £1,710.00 |

Material

Reinforced 3.2mm Acrylic

Bathtub Weight (unfilled)

32KG - 1500mm

34KG - 1600mm

36KG - 1700mm

Capacity

248L - 1500mm

260L - 1600mm

292L - 1700mm

Finish

Gloss White

Features:

- Integrated Overflow Channel
- Adjustable Height Levelling Feet
- Space Saving - 1500mm
- Double Ended

Compatible Tap Types:

- Freestanding Bath Shower Mixer
- Freestanding Bath Filler
- Wall Mounted Bath Filler

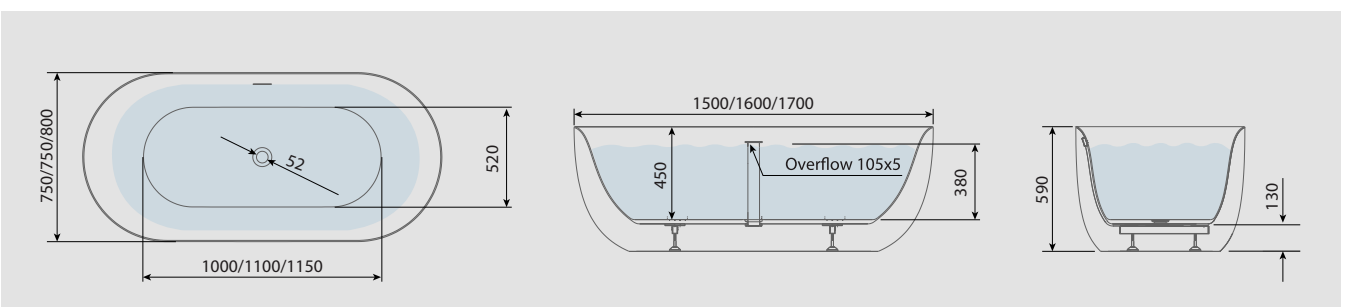

Don't forget to complete your bathtub by choosing your click waste, see page 132

NOTE



Back To Wall Bathtub

| | | |
|--------|--------------------|-----------|
| BAF103 | 1700 x 820 x 585mm | £1,710.00 |
| BAF106 | 1500 x 750 x 580mm | £1,610.00 |



Material

Reinforced 3.2mm Acrylic

Bathtub Weight (unfilled)

44KG - 1700mm

36KG - 1500mm

Capacity

270L - 1700mm

208L - 1500mm

Finish

Gloss White

Features:

- Integrated Overflow Channel
- Back To Wall Fitted Style
- Adjustable Height Levelling Feet
- Space Saving 1500 option
- Double Ended

Compatible Tap Types:

- Freestanding Bath Shower Mixer
- Deck Mounted Bath Filler
- Wall Mounted Bath Filler

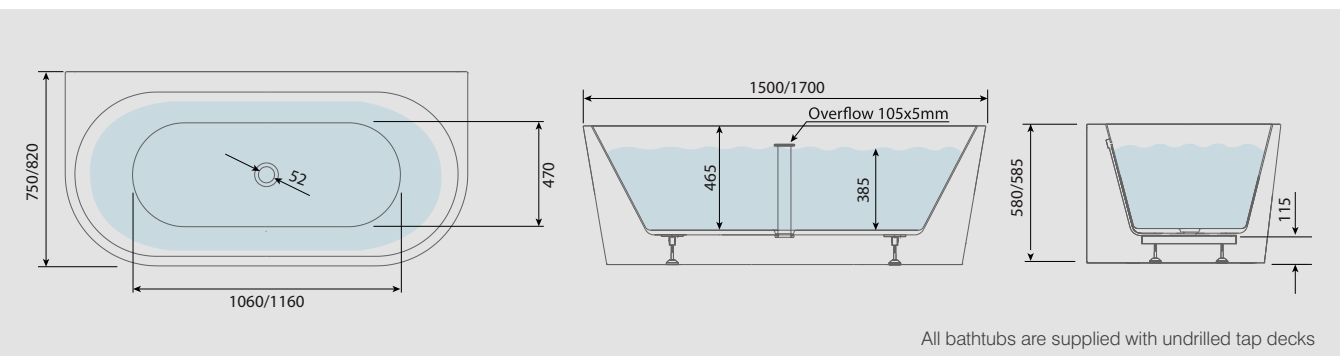

All bathtubs are supplied with undrilled tap decks

Don't forget to complete your bathtub by choosing your click waste, see page 132

NOTE



Corner Shower Bathtub

| | | |
|--------|----------------------------|-----------|
| BAF101 | 1700 x 820 x 595mm - Left | £1,710.00 |
| BAF102 | 1700 x 820 x 595mm - Right | £1,710.00 |
| BAF104 | 1500 x 800 x 595mm - Left | £1,610.00 |
| BAF105 | 1500 x 800 x 595mm - Right | £1,610.00 |



Left hand orientation shown

Material

Reinforced 3.2mm Acrylic

Bathtub Weight (unfilled)

39KG - 1700mm

35KG - 1500mm

Capacity

249L - 1700mm

201L - 1500mm

Finish

Gloss White

Features:

- Integrated Overflow Channel
- Adjustable Height Levelling Feet
- Space Saving 1500 option
- Double Ended
- Tap Deck
- Corner Fitting - Compatible With Showers

Compatible Tap Types:

- Freestanding Bath Shower Mixer
- Deck Mounted Bath Filler
- Wall Mounted Bath Filler

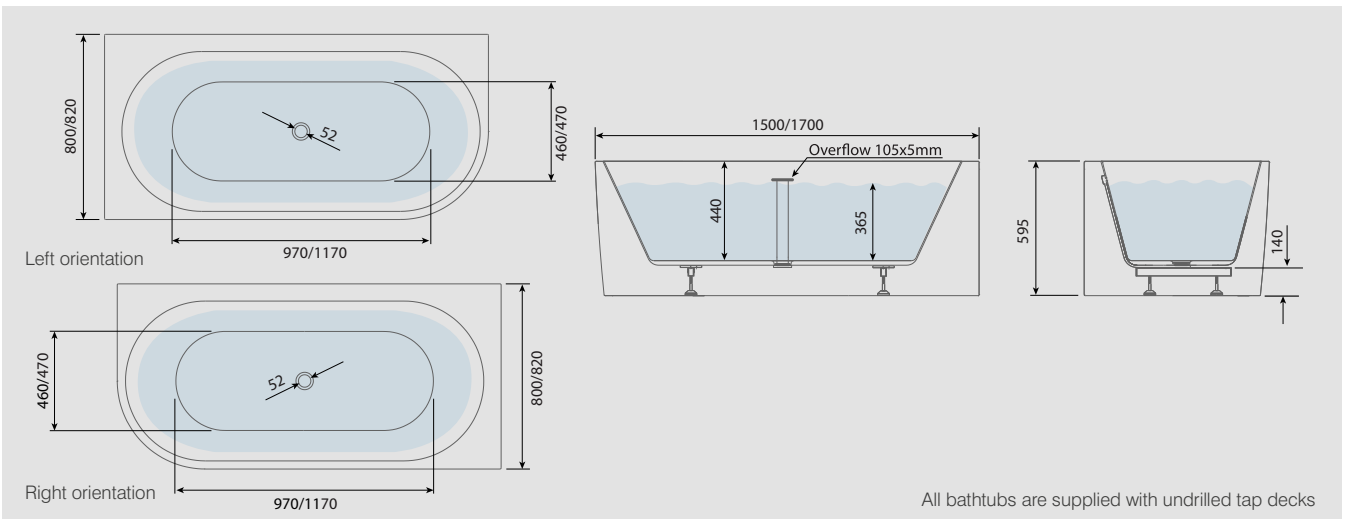

Don't forget to complete your bathtub by choosing your click waste, see page 132

ACCESSORIES



Bathtub Click Waste

Complete your contemporary bath with the addition of a coordinating waste, available in seven sophisticated finishes to suit your chosen brassware.

- Operates with a simple click mechanism
- Specially plated for improved scratch resistance and durability
- Compatible with all Roper Rhodes baths

Bathtub Click Waste

Available in seven finishes

| | | |
|----------------|---------------|---------------|
| Gloss White | BAA118 | £48.20 |
| Chrome | BAA106 | £48.20 |
| Black | BAA105 | £69.50 |
| Brushed Brass | BAA107 | £96.20 |
| Gunmetal | BAA119 | £96.20 |
| Brushed Bronze | BAA120 | £96.20 |
| Brushed Nickel | BAA121 | £96.20 |

To be used with Contemporary Roper Rhodes bathtubs



HARROW

Double Ended Roll Top Bathtub

| | | |
|--------|--------------------|-----------|
| BAC104 | 1610 x 785 x 695mm | £1,770.00 |
| BAC105 | 1770 x 785 x 695mm | £1,820.00 |



GUARANTEE



Material

Reinforced 3.2mm Acrylic

Bathtub Weight (unfilled)

38KG - 1610mm

40KG - 1700mm 41KG

Capacity

195L - 1610mm

230L - 1700mm

Finish

Gloss White

Features:

- Integrated Overflow Channel
- Adjustable Height Levelling Feet
- Space Saving - 1610mm
- Can Be Painted If Desired
- Double Ended

Compatible Tap Types:

- Freestanding Bath Shower Mixer
- Freestanding Bath Filler
- Wall Mounted Bath Filler

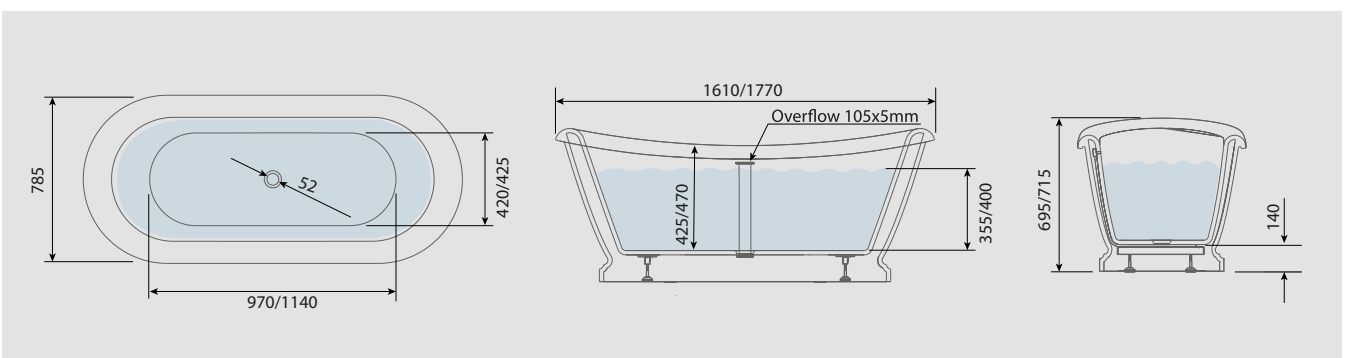

Don't forget to complete your bathtub by choosing your click waste, see page 132

WIDCOMBE

Double Ended Slipper Bathtub

BAT104 1750 x 710 x 800mm £940.00



Material

Reinforced 3.2mm Acrylic

Bathtub Weight (unfilled)

31KG

Capacity

195L

Finish

Gloss White

Features:

- Height Adjustable Floor Fixings Provided With All Feet
- Can Be Painted If Desired
- Double Ended
- Tap Deck

Compatible Tap Types:

- Deck Mounted Bath Filler



All Roper Rhodes bathtubs are supplied in a white gloss outer surface. If you wish to paint your bath, please use suitable acrylic primers and paint. If in doubt, seek advice from the paint manufacturer.

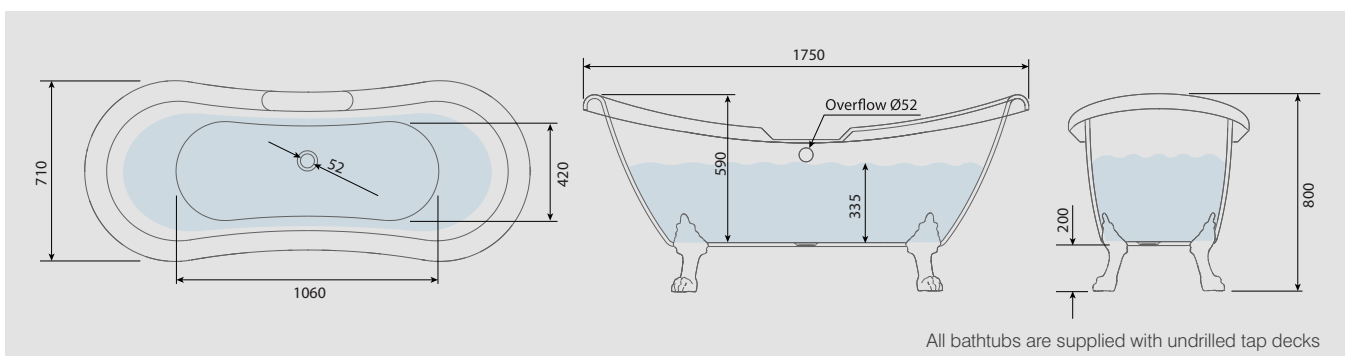

All bathtubs are supplied with undrilled tap decks

Don't forget to complete your bathtub by choosing your traditional bathtub accessories, see page 138

WIDCOMBE

Double Ended Roll Top Bathtub

| | | |
|--------|--------------------|---------|
| BAT101 | 1535 x 775 x 620mm | £940.00 |
| BAT102 | 1695 x 740 x 620mm | £940.00 |



GUARANTEE



Material

Reinforced 3.2mm Acrylic

Bathtub Weight (unfilled)

38KG - 1610mm

40KG - 1700mm 41KG

Capacity

1500mm - 28KG

1700mm - 30KG

Finish

Gloss White

Features:

- Height Adjustable Floor Fixings Provided With All Feet
- Can Be Painted If Desired
- Space Saving - 1535mm
- Floor Fixings Kit Provided
- Tap Deck
- Double Ended

Compatible Tap Types:

- Deck Mounted Bath Filler



All Roper Rhodes bathtubs are supplied in a white gloss outer surface. If you wish to paint your bath, please use suitable acrylic primers and paint. If in doubt, seek advice from the paint manufacturer.

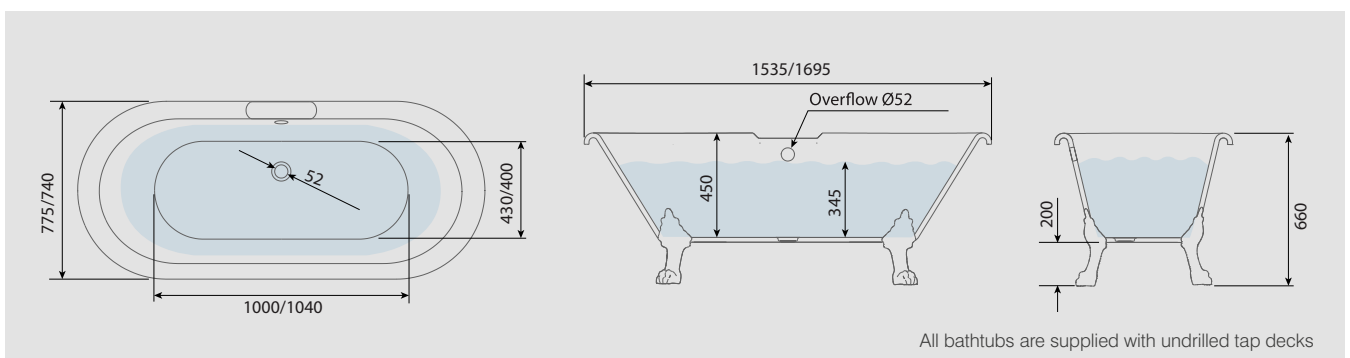

Don't forget to complete your bathtub by choosing your traditional bathtub accessories, see page 138

WIDCOMBE

Single Ended Slipper Bathtub

BAT103 1550 x 720 x 790mm £940.00

10
YEAR

apex

GUARANTEE



Material

Reinforced 3.2mm Acrylic

Bathtub Weight (unfilled)

28KG

Capacity

159L

Finish

Gloss White

Features:

- Height Adjustable Floor Fixings Provided With All Feet
- Can Be Painted If Desired
- Space Saving
- Single Ended

Compatible Tap Types:

- Freestanding Bath Shower Mixer
- Bath Shower Mixer & Stand Pipes



All Roper Rhodes bathtubs are supplied in a white gloss outer surface. If you wish to paint your bath, please use suitable acrylic primers and paint. If in doubt, seek advice from the paint manufacturer.

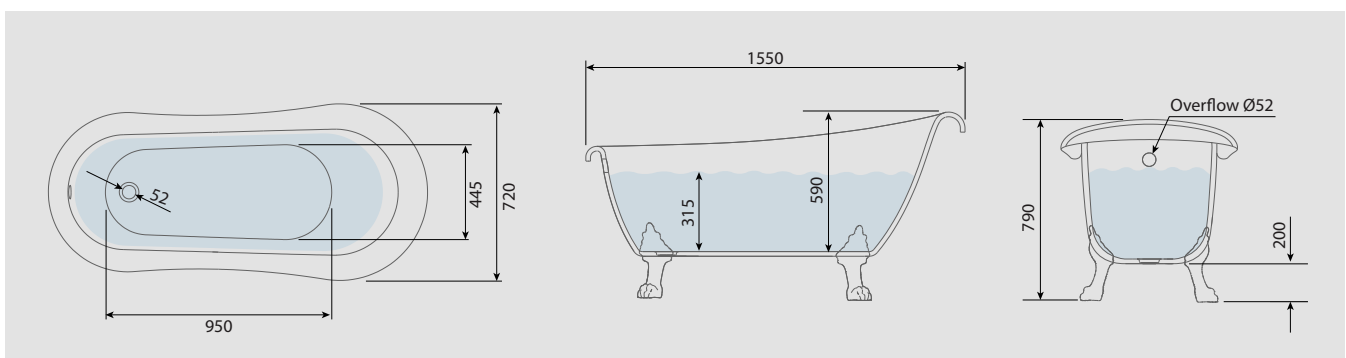

Don't forget to complete your bathtub by choosing your traditional bathtub accessories, see page 138

WIDCOMBE



GUARANTEE

Corner Shower Bathtub

| | | |
|---------------|----------------------------|----------------|
| BAT105 | 1680 x 750 x 640mm - Left | £940.00 |
| BAT106 | 1680 x 750 x 640mm - Right | £940.00 |



Left hand orientation shown

Material

Reinforced 3.2mm Acrylic

Bathtub Weight (unfilled)

34KG

Capacity

192L

Finish

Gloss White

Features:

- Height Adjustable Floor Fixings Provided With All Feet
- Can Be Painted If Desired
- Optional Undrilled Tap Deck
- Single Ended
- Compatible With Showers

Compatible Tap Types:

- Deck Mounted Bath Filler
- Wall Mounted Bath Filler



Don't forget to complete your bathtub by choosing your traditional bathtub accessories, see page 138

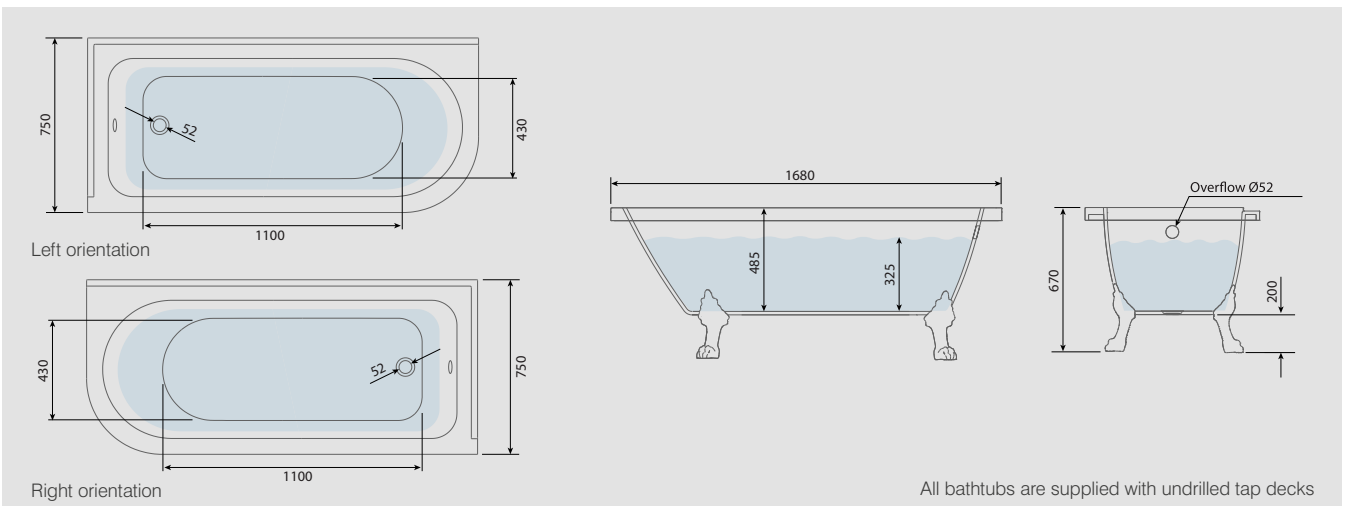

All bathtubs are supplied with undrilled tap decks

All Roper Rhodes bathtubs are supplied in a white gloss outer surface. If you wish to paint your bath, please use suitable acrylic primers and paint. If in doubt, seek advice from the paint manufacturer.

ACCESSORIES

BATHTUB FEET

Cast from robust aluminium and expertly finished, our bath feet are inspired by the original Regency lion paw design and are designed to be paired with our traditional baths. Available in four finishes to suit any scheme.

- One pack of feet contains four feet and all fixings required.
- The feet are universal and work on all traditional tub options
- Feet are supplied with floor fixings to secure the bath tub in position and have a height adjustable levelling feature



Available in four finishes

| | | |
|--------|---------------|---------|
| BAA102 | White | £187.50 |
| BAA104 | Chrome | £187.50 |
| BAA101 | Matt Black | £284.00 |
| BAA103 | Brushed Brass | £348.00 |



EXPOSED OVERFLOW KITS

Available in click mechanism and chain waste options.

- The overflow and waste is universal and compatible with all traditional tubs.
- The pipe can be cut down to suit all Roper Rhodes traditional bath tub models.

Exposed Overflow Kit with Click Waste Available in two finishes

| | | |
|--------|---------------|---------|
| BAA108 | Chrome | £241.00 |
| BAA109 | Brushed Brass | £385.00 |

Exposed Overflow Kit with Plug & Chain Waste Available in two finishes

| | | |
|--------|---------------|---------|
| BAA110 | Chrome | £177.00 |
| BAA111 | Brushed Brass | £283.00 |

P TRAPS

An essential part of a bathtubs plumbing system, our high quality P-traps ensure safe and efficient drainage while also coordinating with your chosen brassware. Constructed in robust brass and expertly plated.

- This connects to either the click waste or the chain waste depending upon your choice.
- The opposing end of the trap connects to the drain pipe.



Available in two finishes

| | | |
|--------|---------------|---------|
| BAA112 | Chrome | £69.50 |
| BAA113 | Brushed Brass | £102.00 |



EXPOSED DRAIN PIPES

When used with a P-trap, our exposed drain pipes provide efficient and functional draining from your bathtub. Available in two finishes, this component can be cut to the required length.

- This 40mm pipe connects to P-trap and then to the waste pipe to drain the water away whilst keeping the finish of the rest of the accessories.
- It comes with a shroud to cover the exit point to the wall or floor.
- The pipe is cut down by the fitter to the required length.

Available in two finishes

| | | |
|---------------|---------------|----------------|
| BAA114 | Chrome | £123.50 |
| BAA115 | Brushed Brass | £225.00 |



BATHTUB SHROUDS

Functional and aesthetic, standpipes and shrouds conceal unsightly pipework while supporting your bath filler or bath/shower mixer. Available in a high shine chrome and brushed brass finish. See pages 196-199 for the Keswick bath filler or bath/shower mixer.

Shrouds

Available in two finishes

| | | |
|---------------|---------------|----------------|
| BAA116 | Chrome | £257.00 |
| BAA117 | Brushed Brass | £385.00 |



STANDPIPES

Standpipes

Available in two finishes

| | | |
|----------------|---------------|----------------|
| T262102 | Chrome | £550.00 |
| T262104 | Brushed Brass | £600.00 |



BASINS & WCs



Explore our basin & WC

COLLECTION

Discover style in every corner of the bathroom with our collection of fine ceramics, all designed by our specialist product designers.

Contemporary forms combine with their expert know-how to give you the best selection of stylish and practical basins, WCs and flushing solutions.

Discover

ROPER RHODES BASINS, WCs & FLUSHING



WC & BASIN SOLUTIONS FOR ALL SPACES

Our basins and WC collections offer a breadth of solutions for all bathroom sizes, no matter how big or small. Covering both modern, contemporary and timeless classics, there is a solution for all styles. Delve in and explore for yourself...

20 YEAR GUARANTEE

At Roper Rhodes, we pride ourselves in offering high quality products that are built to last, even in the hectic and high traffic space that is the bathroom. That's why all of our basins and WC's benefit from a 20 year guarantee. We provide a 10 year guarantee on seats and 5 years on cistern fittings.



AIR GAP TECHNOLOGY

All Roper Rhodes closed coupled WC cisterns are now supplied with air gap technology, they also benefit for a WRAS approved inlet and flush valves, and have a built in silencer to reduce water fill noise levels.



The quiet revolution in toilet technology. Designed to operate with significantly less noise than standard flush systems, Hush flush™ delivers a discreet, whisper-quiet performance without compromising on power.



DESIGNED TO LAST

Rest assured all our seats are fully tested through a drop test of a weight of 75kg from a height of 30mm to 15,000 cycles. So you can be sure our seats will last once installed.



PREMIUM FLUSH PLATES

Our premium flushplate sets a new standard in both design and functionality, featuring a high-quality stainless steel front plate that offers a more luxurious feel. Its ultra-slim 4mm profile allows it to sit almost flush against the wall, creating a sleek, modern aesthetic. Available in a wide range of finishes. Our brushed finishes are treated with a durable PVD coating to ensure long-lasting colour and a anti-fingerprint design.

Basins & WCs

FABER COLLECTION

20
YEAR

GUARANTEE
for basins
& WCs

10
YEAR

GUARANTEE
for WC seats

5
YEAR

GUARANTEE
for cistern
fittings





**Close coupled fully enclosed
WC & soft close seat** 4.5/3L*
365(w) x 840(h) x 650(d)mm

| | | |
|---------|---------|----------------|
| WC | DC14074 | £385.00 |
| Cistern | DC14075 | £153.00 |
| Seat | DC14078 | £116.50 |



Back to wall WC & soft close seat
365(w) x 400(h) x 545(d)mm

| | | |
|------|---------|----------------|
| WC | DC14073 | £332.00 |
| Seat | DC14078 | £116.50 |

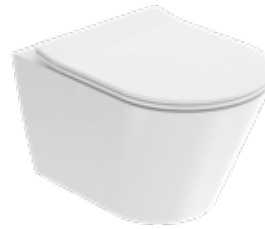

Wall hung WC & soft close seat
365(w) x 330(h) x 540(d)mm

| | | |
|------|---------|----------------|
| WC | DC14076 | £332.00 |
| Seat | DC14078 | £116.50 |



OPTIONAL UPGRADES
Black, brushed brass, gunmetal, brushed nickel or brushed bronze flush buttons and cover caps are now available, see page 169 for further details.

*Close coupled WC Spigot distance from wall 120mm



All Faber WC pans benefit from a whisper quiet flush. Designed to operate with significantly less noise than standard flush systems, Hush flush™ delivers a discreet, whisper-quiet performance without compromising on power.



**Standard depth
semi-countertop basin**
Min furniture depth 275mm
560(w) x 130(h) x 450(d)mm

DC14004 £230.00



**Slim depth
semi-countertop basin**
Min furniture depth 218mm
540(w) x 145(h) x 385(d)mm

DC14005 £207.00



Slim Soft Close Toilet Seat
368(w) x 450(d)mm

DC14078 £116.50



**Wrap Over Slim Soft Close
Toilet Seat**
365(w) x 458(d)mm

DC14077-SF £106.50



CHOOSE
ONE OF OUR
PREMIUM
FLUSH PLATES
SEE PAGE 164

FOR USE WITH FITTED FURNITURE

OVERFLOW UPGRADES



| | | |
|----------------|--------|--------|
| Black | OVMCBK | £11.30 |
| Brushed Brass | OVMCA | £11.30 |
| Gunmetal | OVMCGM | £11.30 |
| Brushed nickel | OVMCBN | £11.30 |
| Brushed bronze | OVMCBZ | £11.30 |

The Faber collection

ELEVATE YOUR SPACE

FABER MIRRORS

Other styles and finishes available, see page 310

FABER TAPS

Other styles and finishes available, see page 180

FABER ACCESSORIES

Other styles and finishes available, see page 278

FABER 800 UNIT IN MATT POWER GREY

Other sizes and finishes available, see page 42

FABER BAR VALVE SHOWER

Other sizes and finishes available, see page 238

FABER CLOSE COUPLED PAN & SOFT CLOSE SEAT

Other style options available, see page 144



Basins & WCs

HAMPTON COLLECTION

20
YEAR

GUARANTEE
for basins
& WCs

10
YEAR

GUARANTEE
for WC seats

5
YEAR

GUARANTEE
for cistern
fittings



OPTIONAL UPGRADE

Black, brushed brass, gunmetal, brushed nickel or brushed bronze flush buttons and cover caps are now available, see page 169 for further details.



**Open back WC with button
& soft close seat**
376(w) x 850(h) x 680(d)mm

| | | |
|---------|------------|----------------|
| WC | HAMCCPAN2 | £328.00 |
| Cistern | HAMTNK* | £151.00 |
| Seat | HAMSCTS-SF | £103.00 |

Spigot distance from wall 180mm

*Chrome flush button included



**Fully enclosed WC with Button
& soft close seat**
376(w) x 850(h) x 680(d)mm

| | | |
|---------|------------|----------------|
| WC | HAMCCPAN | £349.00 |
| Cistern | HAMTNK* | £151.00 |
| Seat | HAMSCTS-SF | £103.00 |

Spigot distance from wall 170mm



**Back to wall WC
& soft close seat**
376(w) x 440(h) x 545(d)mm

| | | |
|------|------------|----------------|
| WC | HAMBWPAN | £311.00 |
| Seat | HAMSCTS-SF | £103.00 |



**Semi-countertop basin
1 Tap Hole**
Min furniture depth 275mm
490(w) x 140(h) x 420(d)mm

| | |
|------------|----------------|
| W3SCBAS1TH | £230.00 |
|------------|----------------|



**Semi-countertop basin
2 Tap Hole**
Min furniture depth 275mm
490(w) x 140(h) x 420(d)mm

| | |
|------------|----------------|
| W3SCBAS2TH | £230.00 |
|------------|----------------|



**Slim depth semi-countertop
basin 1 Tap Hole**
Min furniture depth 218mm
490(w) x 140(h) x 370(d)mm

| | |
|------------|----------------|
| W2SCBAS1TH | £207.00 |
|------------|----------------|



**Slim depth semi-countertop
basin 2 Tap Hole**
Min furniture depth 218mm
490(w) x 140(h) x 370(d)mm

| | |
|------------|----------------|
| W2SCBAS2TH | £207.00 |
|------------|----------------|



**Soft Close Quick Release
Slim Thermoset Toilet Seat**
375(w) x 430(d)mm

| | | |
|----------------------|------------|----------------|
| Chrome hinges | HAMSCTS-SF | £103.00 |
| Hinge upgrade | | |
| Black hinges | DC4032 | £19.70 |
| Brass hinges | DC4033 | £33.90 |
| Gunmetal hinges | DC4034 | £35.60 |
| Bronze hinges | DC4046 | £33.90 |



White wooden toilet seat
375(w) x 430(d)mm

| | | |
|---------------|------------|----------------|
| Chrome hinges | HSCTSW-SF | £137.50 |
| Brass hinges | HSCTSWB-SF | £137.50 |



**Painted wooden soft close
toilet seat**
369(w) x 300(h) x 490(d)mm

| | | |
|------------|-----------|----------------|
| Matt Agave | DC4010-SF | £135.00 |
| Matt Mocha | DC4006-SF | £135.00 |

Brushed brass hinges

| | | |
|--------|--------|---------------|
| Hinges | DC4025 | £37.50 |
|--------|--------|---------------|

Oak Wooden Toilet Seat

375(w) x 430(d)mm

| | | |
|--------------|------------|----------------|
| Chrome hinge | HSCTSNO-SF | £153.00 |
|--------------|------------|----------------|



**Soft close moulded wooden
quick release toilet seat**
369(w) x 300(h) x 490(d)mm

| | | |
|---------------|------------|----------------|
| Chrome hinges | HASCTSB-SF | £137.50 |
| Brass hinges | HASCTSBBSF | £137.50 |

Basins & WCs

WIDCOMBE COLLECTION

20
YEAR

GUARANTEE
for basins
& WCs

10
YEAR

GUARANTEE
for WC seats

5
YEAR

GUARANTEE
for cistern
fittings



OPTIONAL UPGRADES FOR THERMOSET SEATS
Black, brushed brass, gunmetal or brushed bronze cover caps
for our thermoset seat. See page 169 for further details. Only for
use with WSCTS-SF



Close coupled WC & soft close seat 6/4L*
360(w) x 825(h) x 620(d)mm

| | | |
|----------------|----------|----------------|
| WC | WCCPAN2 | £326.00 |
| Thermoset seat | WSCTS-SF | £106.50 |

Choose your cistern and handle finish

| | | |
|------------------------------|-----------|----------------|
| Chrome handle cistern | WCCTNKCHR | £176.00 |
| Brushed brass handle cistern | WCCTNKBRS | £207.50 |

*Close coupled WC Spigot distance from wall 140mm



Close coupled fully enclosed WC & soft close seat 6/4L*
360(w) x 825(h) x 620(d)mm

| | | |
|----------------|----------|----------------|
| WC | WCCPAN | £361.00 |
| Thermoset seat | WSCTS-SF | £106.50 |

Choose your cistern and handle finish

| | | |
|------------------------------|-----------|----------------|
| Chrome handle cistern | WCCTNKCHR | £176.00 |
| Brushed brass handle cistern | WCCTNKBRS | £207.50 |



Back to Wall WC & Seat
360(w) x 410(h) x 490(d)mm

| | | |
|----------------|----------|----------------|
| WC | WBWPAN | £315.00 |
| Thermoset seat | WSCTS-SF | £106.50 |

CISTERN CHOICE
Choose a chrome or brushed brass handle version of your Widcombe cistern



Semi-countertop basin 1 Tap Hole
Min furniture depth 275mm
490(w) x 140(h) x 420(d)mm

| | |
|------------|----------------|
| W3SCBAS1TH | £230.00 |
|------------|----------------|



Semi-countertop basin 2 Tap Hole
Min furniture depth 275mm
490(w) x 140(h) x 420(d)mm

| | |
|------------|----------------|
| W3SCBAS2TH | £230.00 |
|------------|----------------|



Slim depth semi-countertop basin 1 Tap Hole
Min furniture depth 218mm
490(w) x 140(h) x 370(d)mm

| | |
|------------|----------------|
| W2SCBAS1TH | £207.00 |
|------------|----------------|



Slim depth semi-countertop basin 2 Tap Hole
Min furniture depth 218mm
490(w) x 140(h) x 370(d)mm

| | |
|------------|----------------|
| W2SCBAS2TH | £207.00 |
|------------|----------------|

ALTERNATIVE TOILET SEATS

Moulded wood toilet seats are available to match the Widcombe furniture range



Widcombe soft close wooden toilet seat

| | | |
|--------------|------------|----------------|
| 1. Canvas | WSCTS01-SF | £106.50 |
| 2. Parchment | WSCTS02-SF | £106.50 |
| 3. Pewter | WSCTS03-SF | £106.50 |
| 4. Twilight | WSCTS04-SF | £106.50 |



Optional upgrades for wooden toilet seats

Brushed brass cover caps & hinges available for the painted seats.

| | | |
|---------------|--------|---------------|
| Brushed brass | DC4025 | £37.50 |
|---------------|--------|---------------|



All Widcombe seats benefit from Secure-Fix technology, helping keep the seat firmly in place.

Basins & WCs

HARROW COLLECTION

20
YEAR

GUARANTEE
for basins
& WCs

10
YEAR

GUARANTEE
for WC seats

5
YEAR

GUARANTEE
for cistern
fittings





High Level WC & seat
481(w) x 2380max(h) x 635(d)mm

| | | |
|------------------|---------|----------------|
| WC | HLHPAN | £193.50 |
| Cistern | HHLTnk | £185.00 |
| Chrome Flush Kit | HHLKCHR | £414.00 |
| Brass Flush Kit* | HHLKBRS | £496.00 |

* Brass flush kit includes brass flush handle



Low Level WC & seat
481(w) x 1157max(h) x 700(d)mm

| | | |
|------------------|---------|----------------|
| WC | HLHPAN | £193.50 |
| Cistern | HLLTnk | £185.00 |
| Chrome Flush Kit | HLLKCHR | £83.90 |
| Brass Flush Kit* | HLLKBRS | £128.00 |



Close coupled WC & seat
481(w) x 769(h) x 705(d)mm

| | | |
|---------|--------|----------------|
| WC | HCCPAN | £223.50 |
| Cistern | HCCTnk | £185.50 |

Supplied with chrome flush handle, brass upgrade available see below



Back to wall WC & seat
385(w) x 410(h) x 520(d)mm

| | | |
|----|--------|----------------|
| WC | HBWPAN | £282.00 |
|----|--------|----------------|



Cloakroom basin & pedestal 2TH
500(w) x 895(h) x 305(d)mm

| | | |
|-----------|--------|----------------|
| 2TH basin | H50CDB | £148.50 |
| Pedestal | HPED | £74.70 |

Can also be wall mounted without pedestal



605mm square basin & pedestal 1 or 2TH options
605(w) x 910(h) x 505(d)mm

| | | |
|-----------|-------|----------------|
| 1TH basin | H60SB | £187.50 |
| 2TH basin | H60DB | £187.50 |
| Pedestal | HPED | £74.70 |

1TH - supplied with no chain waste



Semi-countertop basin 1TH

| | |
|----------|----------------|
| H3SCBAS1 | £223.50 |
|----------|----------------|

Min furniture depth 270mm
550(w) x 195(h) x 435(d)mm



Semi-countertop basin 2TH

| | |
|----------|----------------|
| H3SCBAS2 | £223.50 |
|----------|----------------|

Min furniture depth 270mm
550(w) x 195(h) x 435(d)mm

TOILET SEAT OPTIONS



Secure-Fix QR

White Wooden Toilet Seat
375(w) x 430(d)mm

| | | |
|--------------|------------|----------------|
| Chrome hinge | HSCTSW-SF | £137.50 |
| Brass hinge | HSCTSWB-SF | £137.50 |



Secure-Fix QR

Oak Wooden Toilet Seat
375(w) x 430(d)mm

| | | |
|--------------|------------|----------------|
| Chrome hinge | HSCTSNO-SF | £153.00 |
|--------------|------------|----------------|



PAGE 342

ALTERNATIVE TOILET SEATS

Pair your Harrow WC with one of our 4 painted toilet seats, see page 342



HANDLE CHOICE

Upgrade from a chrome to brushed brass handle for your Harrow cistern



Flush handle

| | | |
|---------------|--------|---------------|
| Brushed brass | TR9042 | £68.40 |
|---------------|--------|---------------|

Basins & WCs

ELKA COLLECTION

20
YEAR

GUARANTEE
for basins
& WCs

10
YEAR

GUARANTEE
for WC seats

5
YEAR

GUARANTEE
for cistern
fittings



RIMLESS DESIGN

All Elka WC are hygienic, easy to clean and benefit from rimless technology



OPTIONAL UPGRADE

Black, gunmetal, brushed brass, nickel or bronze flush buttons and cover caps are now available, see page 169 for further details.



**Close coupled WC
& slim soft close seat 6/4L**
365(w) x 852(h) x 620(d)mm

| | | |
|---------|-------------|----------------|
| WC | ELCCPAN | £182.50 |
| Cistern | ELCCTNK | £106.50 |
| Seat | ELSLSCTS-SF | £106.50 |

Spigot distance from wall 130mm



**Close coupled fully enclosed
WC & slim soft close seat 6/4L**
365(w) x 852(h) x 620(d)mm

| | | |
|---------|-------------|----------------|
| WC | ELCCFPAN | £216.50 |
| Cistern | ELCCTNK | £106.50 |
| Seat | ELSLSCTS-SF | £106.50 |

Spigot distance from wall 140mm



**Comfort height close coupled
WC & slim soft close seat 6/4L**
365(w) x 905(h) x 620(d)mm

| | | |
|---------|-------------|----------------|
| WC | ELCHCCPAN | £220.00 |
| Cistern | ELCCTNK | £106.50 |
| Seat | ELSLSCTS-SF | £106.50 |

Spigot distance from wall 125mm



**Comfort height close coupled fully
enclosed WC & slim soft close seat
6/4L** 365(w) x 905(h) x 620(d)mm

| | | |
|---------|-------------|----------------|
| WC | ELCHCCFPAN | £261.00 |
| Cistern | ELCCTNK | £106.50 |
| Seat | ELSLSCTS-SF | £106.50 |

Spigot distance from wall 125mm

OVERFLOW UPGRADES



| | | |
|----------------|--------|---------------|
| Black | OVMCBK | £11.30 |
| Brushed Brass | OVMCA | £11.30 |
| Gunmetal | OVMCGM | £11.30 |
| Brushed nickel | OVMCBN | £11.30 |
| Brushed bronze | OVMCBZ | £11.30 |



**Back to wall WC
& slim soft close seat**
365(w) x 410(h) x 490(d)mm

| | | |
|------|-------------|----------------|
| WC | ELBW PAN | £197.00 |
| Seat | ELSLSCTS-SF | £106.50 |



**Comfort height back to wall WC
& slim soft close seat**
365(w) x 465(h) x 490(d)mm

| | | |
|------|-------------|----------------|
| WC | ELCHBWPAN | £236.50 |
| Seat | ELSLSCTS-SF | £106.50 |



**Wall hung WC
& slim soft close seat**
360(w) x 320(h) x 510(d)mm

| | | |
|------|-------------|----------------|
| WC | ELWHPAN | £277.00 |
| Seat | ELSLSCTS-SF | £106.50 |



**Standard depth
semi-countertop basin**
Min furniture depth 275mm
560(w) x 130(h) x 450(d)mm

| | |
|-----------|----------------|
| EL3SCTBAS | £230.00 |
|-----------|----------------|



**Slim depth
semi-countertop basin**
Min furniture depth 218mm
540(w) x 145(h) x 385(d)mm

| | |
|-----------|----------------|
| EL2SCTBAS | £207.00 |
|-----------|----------------|



**Wrap Over Slim Soft Close
Toilet Seat**
363(w) x 425(d)mm

| | |
|-----------|----------------|
| ELSCTS-SF | £106.50 |
|-----------|----------------|



Slim Soft Close Toilet Seat
363(w) x 426(d)mm

| | |
|-------------|----------------|
| ELSLSCTS-SF | £106.50 |
|-------------|----------------|



All Elka seats benefit from Secure-Fix technology, helping keep the seat firmly in place.

Basins & WCs

ARUBA COLLECTION



GUARANTEE
for basins
& WCs



GUARANTEE
for WC seats



GUARANTEE
for cistern
fittings



420mm Basin & Semi Pedestal
420(w) x 425(h) x 360(d)mm

| | | |
|----------|---------|----------------|
| Basin | AR420SB | £134.50 |
| Pedestal | ARSMP | £59.60 |



550mm Basin & Semi Pedestal
550(w) x 435(h) x 425(d)mm

| | | |
|----------|---------|----------------|
| Basin | AR550SB | £179.00 |
| Pedestal | ARSMP | £59.60 |



420mm Basin & Pedestal
420(w) x 850(h) x 360(d)mm

| | | |
|----------|---------|----------------|
| Basin | AR420SB | £134.50 |
| Pedestal | ARPED | £59.60 |



550mm Basin & Pedestal
550(w) x 860(h) x 425(d)mm

| | | |
|----------|---------|----------------|
| Basin | AR550SB | £179.00 |
| Pedestal | ARPED | £59.60 |



**560mm Standard Depth
Semi-Countertop Basin**
560(w) x 155(h) x 430(d)mm

| | | |
|-------|----------|----------------|
| Basin | AR3SCBAS | £230.00 |
|-------|----------|----------------|



**560mm Slim Depth
Semi-Countertop Basin**
560(w) x 145(h) x 355(d)mm

| | | |
|-------|----------|----------------|
| Basin | AR2SCBAS | £207.00 |
|-------|----------|----------------|



Close Coupled Fully Enclosed WC & Wrap Over Seat
340(w) x 840(h) x 620(d)mm

| | | |
|---------|------------|----------------|
| WC | ARCCPAN | £359.00 |
| Cistern | ARCCTNK | £153.00 |
| Seat | ARSCTS2-SF | £106.50 |

Spigot distance from wall 205mm



Close Coupled WC & Wrap Over Seat
340(w) x 840(h) x 620(d)mm

| | | |
|---------|------------|----------------|
| WC | ARCCPAN2 | £326.00 |
| Cistern | ARCCTNK | £153.00 |
| Seat | ARSCTS2-SF | £106.50 |

Spigot distance from wall 200mm



Comfort Height Close Coupled Fully Enclosed WC & Wrap Over Seat
340(w) x 880(h) x 620(d)mm

| | | |
|---------|------------|----------------|
| WC | ARCHCCPAN | £426.00 |
| Cistern | ARCCTNK | £153.00 |
| Seat | ARSCTS2-SF | £106.50 |

Spigot distance from wall 205mm



Comfort Height Close Coupled WC & Wrap Over Seat
340(w) x 880(h) x 620(d)mm

| | | |
|---------|------------|----------------|
| WC | ARCHCCPAN2 | £391.00 |
| Cistern | ARCCTNK | £153.00 |
| Seat | ARSCTS2-SF | £106.50 |

Spigot distance from wall 200mm



Back To Wall WC & Wrap Over Seat
340(w) x 420(h) x 510(d)mm

| | | |
|------|------------|----------------|
| WC | ARBWPAN | £314.00 |
| Seat | ARSCTS2-SF | £106.50 |



Comfort Height Back To Wall WC & Wrap Over Seat
340(w) x 460(h) x 510(d)mm

| | | |
|------|------------|----------------|
| WC | ARCHBWPAN | £363.00 |
| Seat | ARSCTS2-SF | £106.50 |



Wall Hung WC & Wrap Over Seat
340(w) x 355(h) x 510(d)mm

| | | |
|------|------------|----------------|
| WC | ARWHPAN | £314.00 |
| Seat | ARSCTS2-SF | £106.50 |



OPTIONAL UPGRADE
Black, brushed brass, gunmetal, brushed nickel or brushed bronze flush buttons and cover caps are now available, see page 169 for further details.



Wrap Over Soft Close Toilet Seat
345(w) x 425(d)mm

| | |
|-----------|----------------|
| ARSCTS-SF | £106.50 |
|-----------|----------------|

*Chrome / Brushed Nickel seat caps included



Wrap Over Slim Soft Close Toilet Seat
345(w) x 420(d)mm

| | |
|------------|----------------|
| ARSCTS2-SF | £106.50 |
|------------|----------------|

*Chrome / Brushed Nickel seat caps included



Slim Soft Close Toilet Seat
345(w) x 425(d)mm

| | |
|-------------|----------------|
| ARSLSCTS-SF | £116.50 |
|-------------|----------------|

*Chrome / Brushed Nickel seat caps included



All Aruba seats benefit from Secure-Fix technology, helping keep the seat firmly in place.

Basins & WCs

PARADIGM COLLECTION

20
YEAR

GUARANTEE
for basins
& WCs

10
YEAR

GUARANTEE
for WC seats

5
YEAR

GUARANTEE
for cistern
fittings



RIMLESS DESIGN

All Paradigm WC are hygienic, easy to clean and benefit from rimless technology



OPTIONAL UPGRADE

Black, brushed brass, gunmetal, brushed nickel or brushed bronze flush buttons and cover caps are now available, see page 169 for further details.



**Close coupled fully enclosed
WC & soft close seat 5/3L***
369(w) x 825(h) x 640(d)mm

| | | |
|---------|--------|----------------|
| WC | PCCPAN | £355.00 |
| Cistern | PCCTNK | £85.00 |
| Seat | PASCTS | £80.00 |



**Comfort height close coupled
fully enclosed WC & soft close
seat 5/3L***
369(w) x 875(h) x 640(d)mm

| | | |
|---------|----------|----------------|
| WC | PCHCCPAN | £426.00 |
| Cistern | PCCTNK | £85.00 |
| Seat | PASCTS | £80.00 |



**Close coupled WC
& soft close seat 5/3L***
369(w) x 825(h) x 640(d)mm

| | | |
|---------|---------|----------------|
| WC | PCCPAN2 | £321.00 |
| Cistern | PCCTNK | £85.00 |
| Seat | PASCTS | £80.00 |



**Comfort height close coupled
WC & soft close seat 5/3L***
369(w) x 875(h) x 640(d)mm

| | | |
|---------|-----------|----------------|
| WC | PCHCCPAN2 | £384.00 |
| Cistern | PCCTNK | £85.00 |
| Seat | PASCTS | £80.00 |

*Close coupled WC Spigot distance from wall 150mm



**Back to wall WC
& soft close seat**
369(w) x 410(h) x 490(d)mm

| | | |
|------|--------|----------------|
| WC | PBWPAN | £308.00 |
| Seat | PASCTS | £80.00 |



**Comfort height back to wall WC
& soft close seat**
369(w) x 460(h) x 490(d)mm

| | | |
|------|----------|----------------|
| WC | PCHBWPAN | £371.00 |
| Seat | PASCTS | £80.00 |



**Wall hung WC
& soft close seat**
369(w) x 300(h) x 490(d)mm

| | | |
|------|--------|----------------|
| WC | PWHPAN | £199.00 |
| Seat | PASCTS | £80.00 |



**475mm standard depth
semi-countertop basin**
Min furniture depth 275mm
475(w) x 150(h) x 420(d)mm

| | |
|---------|----------------|
| DC14029 | £141.00 |
|---------|----------------|



**475mm slim depth
semi-countertop basin**
Min furniture depth 218mm
475(w) x 150(h) x 370(d)mm

| | |
|---------|----------------|
| DC14028 | £130.50 |
|---------|----------------|

COUNTERTOP BASINS



GUARANTEE
Ceramics

Create a hotel look in your home by upgrading to one of our countertop basin options.

When placed on a worktop, these oval or rectangular basins provide a clean uncluttered finish. A distinctive and attractive alternative to conventional bathroom basin.

Enhance the overall style of your furniture unit by selecting an aspirational solid surface worktop with the natural elegance of stone.

To ensure our countertop basins fit seamlessly into your bathroom, pair them with a compatible worktop. Explore the furniture range pages below to find your perfect match:

Faber - p43

Scheme - p88

System - p97



SLOTTED
WASTE
REQUIRED

Round Basin

380(w) x 155(h) x 380(d)mm

Basin DC12048 **£118.00**



UNSLOTTED
WASTE
REQUIRED

Round Basin*

355(w) x 120(h) x 360(d)mm

Basin DC12049 **£134.00**



UNSLOTTED
WASTE
REQUIRED

Black Round Basin*

355(w) x 120(h) x 360(d)mm

Basin DC12050 **£214.00**



UNSLOTTED
WASTE
REQUIRED

Fluted Round Basin*

355(w) x 115(h) x 355(d)mm

Basin DC12054 **£161.00**



UNSLOTTED
WASTE
REQUIRED

Rectangular Basin*

455(w) x 135(h) x 325(d)mm

Basin DC12053 **£161.00**



UNSLOTTED
WASTE
REQUIRED

Square counter top basin

400(w) x 150(h) x 400(d)mm

Basin DC12052 **£161.00**



UNSLOTTED
WASTE
REQUIRED

Pill Basin*

490(w) x 130(h) x 360(d) mm

Basin DC12051 **£161.00**

* These basins do not have overflows and must be used with an open waste.



Basins & WCs

CISTERNS



6/3L in-wall cistern
600(w) x 595-745(h) x 138-194(d)mm

TR9009 **£165.50**

Ideal for tiled in applications.
All parts serviceable through flush plate aperture.
Internal isolation valve, 150mm height adjustment.
Top or front flush plate mounting.
½" BSP.
Requires flush plate/button, or contactless sensor. (available separately)

6/3L comfort height cistern
with chrome flush button
437(w) x 324(h) x 165(d)mm

TR9008 **£146.00**

Developed specifically to allow comfort height back to wall pans to be used in 820mm high furniture.
Bottom entry inlet valve.
Top or front flush plate mounting.
½" BSP.
PS insulation jacket.
Pneumatic flush valve.

6/3L Torrent concealed cistern
with chrome flush button
434(w) x 365(h) x 135(d)mm

TR9001 **£146.00**

For use in Bathroom Furniture units.
Bottom entry inlet valve.
Top or front flush plate mounting.
½" BSP.
PS insulation jacket.
Pneumatic flush valve.

6/3L Cascade concealed cistern
with chrome flush button
464(w) x 365(h) x 135(d)mm

TR9002 **£146.00**

For use in Bathroom Furniture units.
Side entry inlet valve.
Top or front flush plate mounting.
½" BSP.
PS insulation jacket.
Pneumatic flush valve.

| Concealed cistern compatibility chart | Std depth 500 BTW unit | Std depth 600 BTW unit | Slim depth 500 BTW unit | Slim depth 600 BTW unit | Boxed/tiled-in worktop | Boxed/tiled-in full height |
|--|------------------------|------------------------|-------------------------|-------------------------|------------------------|----------------------------|
| In-wall cistern | | | | | ● | ● |
| Comfort height cistern (for use with comfort height BTW WCs) | ● | ● | ● | ● | | |
| Torrent cistern - bottom inlet | ● | ● | ● | ● | | |
| Cascade cistern - side inlet | ● | ● | ● | ● | | |



GUARANTEE
5 year guarantee for all concealed cisterns



GUARANTEE
10 year guarantee for WC frame components

Basins & WCs

OPTIONAL UPGRADES

Designed to work with furniture back to wall WC units.
Optional upgrades for torrent cisterns.

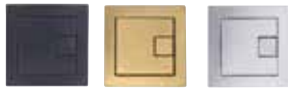

Square dual flush button
72(w) x 72mm(h)

| | | |
|---------------|---------|--------|
| Black | TR9028 | £25.80 |
| Brushed Brass | *TR9035 | £51.50 |
| Chrome | TR9003 | £20.60 |

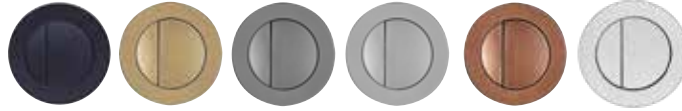

Round dual flush button
72(w) x 72mm(h)

| | | | | | |
|---------------|---------|--------|----------------|---------|--------|
| Black | TR9022 | £25.80 | Brushed Nickel | TR9054 | £51.50 |
| Brushed Brass | *TR9034 | £51.50 | Brushed Bronze | TR9050 | £51.50 |
| Gunmetal | *TR9045 | £51.50 | Chrome | SP12169 | £24.70 |



Oval flush button* 140(w) x 80mm(h)

| | | | | | |
|--------|--------|--------|---------------|---------|---------|
| Chrome | TR9023 | £70.30 | Brushed Brass | *TR9041 | £106.50 |
| Black | TR9040 | £87.80 | Gunmetal | *TR9046 | £106.50 |



* These flush buttons feature an anti-fingerprint finish

WALL HUNG WC FRAMES



1.17M wall hung WC frame
500(w) x 1168(h) x 140 - 200mm(d)
6/3 litres

| | |
|--------|---------|
| TR9006 | £362.00 |
|--------|---------|

Use for in-wall applications.
Includes fittings
Requires flush plate/button,
or contactless sensor
(available separately)
200mm height adjustment.



1.0M wall hung WC frame
500(w) x 1000-1100(h) x 167 - 215mm(d)
6/3 litres

| | |
|--------|---------|
| TR9015 | £362.00 |
|--------|---------|

Ideal for boxed in applications,
especially under windows.
Requires flush plate/button,
or contactless sensor
(available separately)
70mm height adjustment.



0.82M wall hung WC frame
500(w) x 812(h) x 170 - 215mm(d)
6/3 litres

| | | |
|-------------|--------|---------|
| Frame | TR9005 | £362.00 |
| Adaptor Kit | TR9007 | £61.70 |

Can be used with 600mm and
wider furniture WC units.
Use with Furniture Adaptor Kit,
Requires flush plate/button,
or contactless sensor
(available separately)
70mm height adjustment.



0.4M WC/bidet frame
400(w) x 400-600(h) x 200 - 335mm(d)

| | |
|--------|---------|
| TR9018 | £167.50 |
|--------|---------|

Compact half height WC frame
suitable for use in narrow back to
wall units including 500mm wide.
For use with Torrent, Cascade or
comfort height cisterns.
Can also be used for bidets
200mm height adjustment.

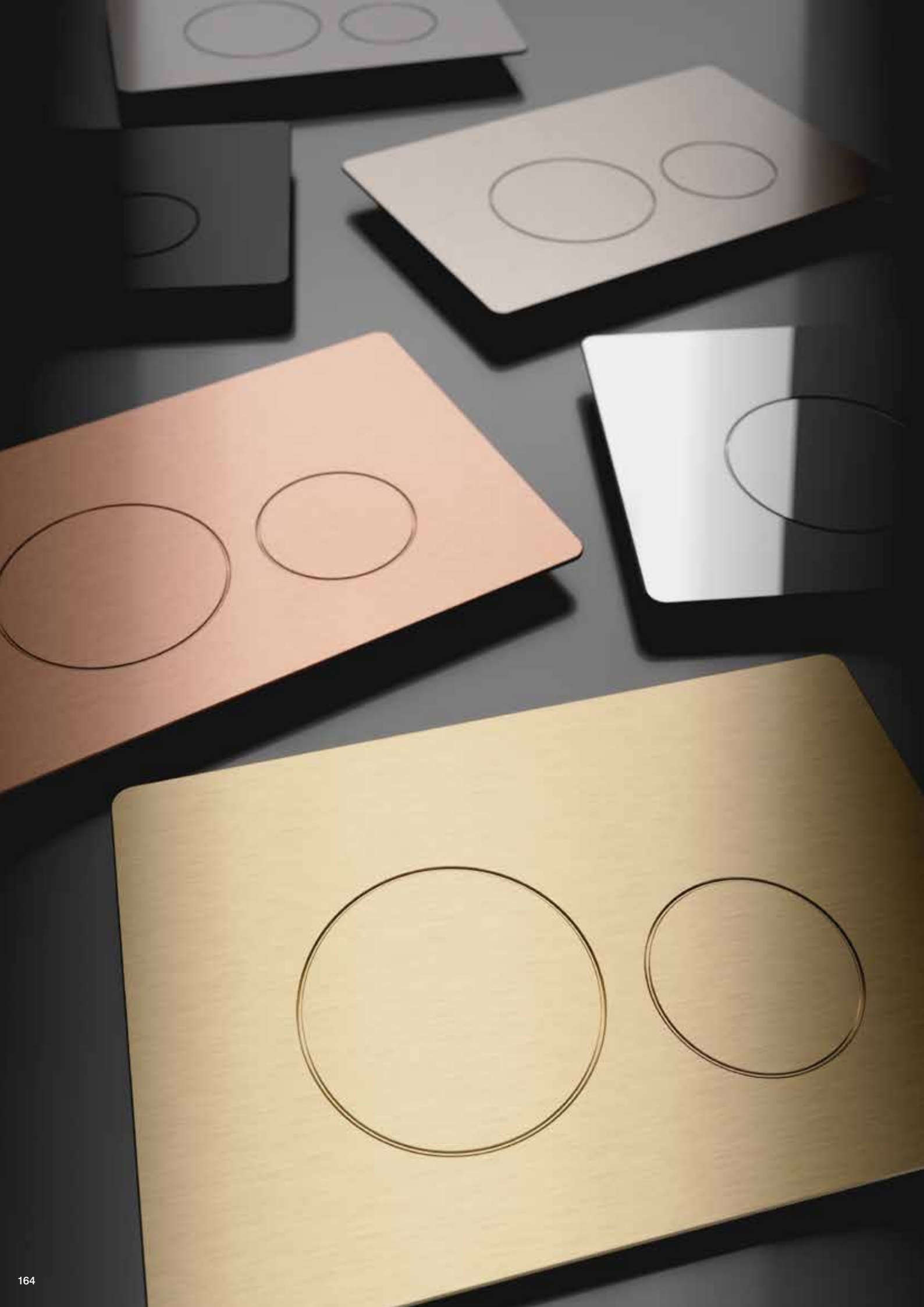

Flushing Solutions

PREMIUM STAINLESS STEEL FLUSH PLATES

Our premium flushplate sets a new standard in both design and functionality, featuring a high-quality stainless steel front plate that offers a more luxurious feel. Its ultra-slim 4mm profile allows it to sit almost flush against the wall, creating a sleek, modern aesthetic. Available in a wide range of finishes, brushed finishes are treated with a durable PVD coating to ensure a long-lasting resistance to wear.

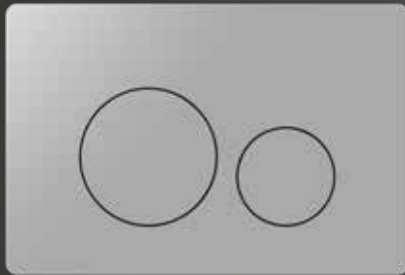

CHROME

TR9057

£110.00



MATT BLACK

TR9058

£110.00

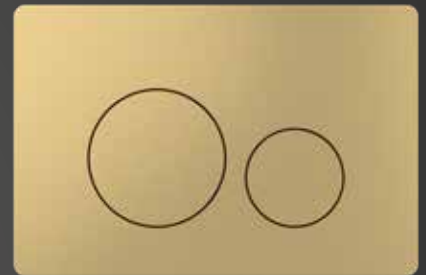

BRUSHED BRASS

TR9059

£129.00

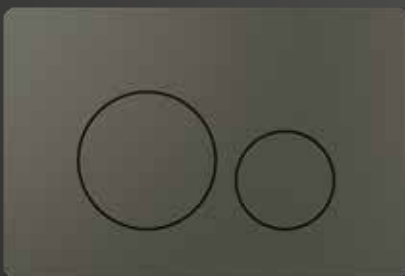

GUNMETAL

TR9062

£129.00



BRUSHED BRONZE

TR9060

£129.00

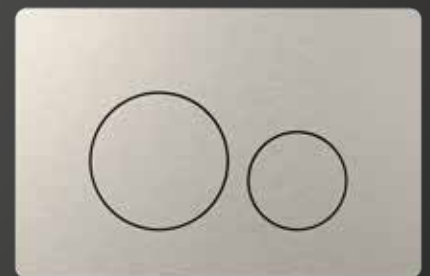

BRUSHED NICKEL

TR9061

£129.00

Flushing solutions

ABS FLUSH PLATES

Whether you need a contemporary or traditional look, we have flush plates to suit. Compatible for use with our wall hung frames or as an optional upgrade for cisterns.



Plaza dual flush push plate
210(w) x 138(h) x 85(d)mm

Black TR9020 **£68.20**



Plaza dual flush push plate
210(w) x 138(h) x 85(d)mm

Brushed brass TR9036 **£111.50**



Plaza dual flush push plate
210(w) x 138(h) x 85(d)mm

Chrome TR9010 **£55.70**



Plaza dual flush push plate
210(w) x 138(h) x 85(d)mm

Stainless steel TR9019 **£133.00**



Rondo dual flush push plate
210(w) x 138(h) x 85(d)mm

Black TR9021 **£68.20**



Rondo dual flush push plate
210(w) x 138(h) x 85(d)mm

Brushed brass TR9037 **£111.50**



Rondo dual flush push plate
210(w) x 138(h) x 85(d)mm

Chrome TR9012 **£55.70**

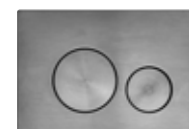

Rondo dual flush push plate
210(w) x 138(h) x 85(d)mm

Gunmetal TR9044 **£111.50**



Rondo dual flush push plate
210(w) x 138(h) x 85(d)mm

Brushed nickel TR9053 **£111.50**



Rondo dual flush push plate
210(w) x 138(h) x 85(d)mm

Brushed bronze TR9049 **£111.50**



Ellipse dual flush push plate
210(w) x 142mm(h)

Chrome TR9004 **£55.70**



Traditional flush push plate
210(w) x 137mm(h)

Chrome TR9017 **£64.00**



Glass flush push plate
210(w) x 137mm(h)

Black TR9029 **£152.00**

FLUSHING OPTIONS COMPATIBILITY CHART

| Product | Code | Plaza flush plates | Rondo flush plates | Traditional flush plate | Ellipse flush plate | Square & round flush buttons | Oval flush buttons | Contactless Sensor | Sensor flush plates |
|-------------------------------------|--------|--------------------|--------------------|-------------------------|---------------------|------------------------------|--------------------|--------------------|---------------------|
| 1.17m wall hung WC frame | TR9006 | ● | ● | ● | ● | ●* | ●* | ●* | ● |
| 1.0m wall hung WC frame | TR9015 | ● | ● | ● | ● | ●* | ●* | ●* | ● |
| 0.82m wall hung WC frame | TR9005 | ● | ● | ● | ● | ●* | ●* | ●* | ● |
| In-wall cistern | TR9009 | ● | ● | ● | ● | ●* | ●* | ●* | ● |
| Comfort height cistern ^Δ | TR9008 | ●+ | ●+ | ●+ | ●+ | ● | ●+ | ● | ●+ |
| Torrent cistern ^Δ | TR9001 | ● | ● | ● | ● | ● | ● | ● | ●+ |
| Cascade cistern ^Δ | TR9002 | ● | ● | ● | ● | ● | ● | ● | ●+ |

^Δ Round button supplied with cistern as standard *Compatible, so long as provision made for maintenance access

† Compatible when used in standard depth furniture only

Concealed Cistern

FLUSHING SOLUTIONS

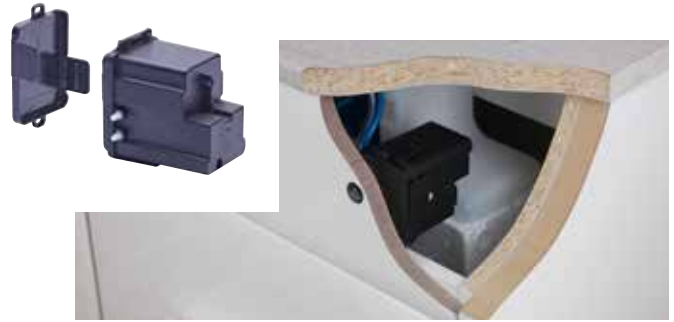

CONTACTLESS DUAL FLUSH SENSOR

- Provides a touchless flush, with just the wave of a hand
- Best used with concealed cisterns in furniture
- Powered by 4 x AA batteries
- Low battery power alarm, battery life in excess of 1 year (normal domestic conditions, good quality batteries)
- Dual flush
- Works through surfaces up to 25mm thick (including ceramic tiles, fascias & worktops)
- Includes black, brushed brass, chrome, gunmetal "buttons" to indicate sensor location or upgrade to a brushed bronze or nickel finish.



Contactless dual flush sensor
use with concealed cisterns

| | | |
|------------|--------|----------------|
| Sensor Kit | TR9014 | £178.00 |
|------------|--------|----------------|

Button upgrade
use with concealed cisterns

| | | |
|----------------|---------|---------------|
| Brushed bronze | SP22765 | £11.40 |
| Brushed nickel | SP22766 | £11.40 |



SENSOR VIDEO
See how easy it is to use & maintain the sensor

CONTACTLESS SENSOR DUAL FLUSH PLATE

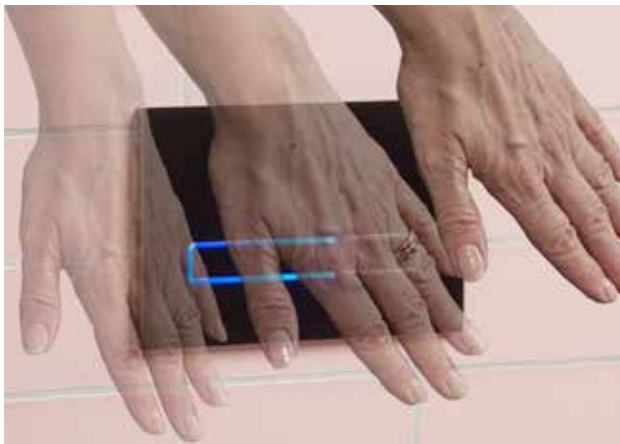

- Recommended for in-wall installations using TR9006 and TR9015
- Contactless flushing
- Powered by 4 x AA batteries (easy to change, no tools required)
- Low battery power alarm (battery life in excess of 1 year)
- Dual flush
- Manual override flush
- Illuminates on operation
- Use on wall hung frames and In-wall cistern (not compatible with slim depth furniture)

Contactless sensor flush plate

210(w) x 142(h) x 113(d)mm

| | | |
|-------|--------|----------------|
| Black | TR9025 | £199.00 |
|-------|--------|----------------|

TOUCH OPERATED SENSOR DUAL FLUSH PLATE



- Recommended for furniture or lower height installations
- Touch operated to prevent inadvertent use
- Powered by 4 x AA batteries (easy to change, no tools required)
- Low battery power alarm (battery life in excess of 1 year)
- Dual flush
- Manual override flush
- Illuminates on operation
- Use on wall hung frames and In-wall cistern (not compatible with slim depth furniture)

Touch operated sensor flush plate

210(w) x 142(h) x 113(d)mm

| | | |
|-------|--------|----------------|
| Black | TR9016 | £199.00 |
|-------|--------|----------------|



SENSOR VIDEO
See how easy it is to use & maintain the sensor

FLUSHING SOLUTIONS



CLOSE COUPLED SENSOR FLUSH KITS

With a simple wave of the hand, hygienic, contactless flushing is now here for close coupled WCs. Two sizes are available depending on the size of the flush button hole in the cistern lid. The button kits have been designed to retro-fit to existing WCs which have paddle operated flush valves. For cisterns which have pneumatic or cable operated flush valves, or where the button screws in directly to the flush valve, then the flush valve will also need to be swapped to our TR9033 valve which has a 2" base.

When upgrading an installed Roper Rhodes cistern the following ranges will require the following items to operate correctly

- Aruba p156 and Elka p154
Flush button kit TR9032
- Faber p145
Flush button kit TR9031



ø38mm close coupled sensor flush button kit

TR9031 **£96.20**



ø48mm close coupled sensor flush button kit

TR9032 **£96.20**



Close coupled flush valve 2" base

TR9033 **£30.90**



SENSOR VIDEO
See how easy it is to install the flush sensor

MATCHING TRIM UPGRADES

WC SEAT COVER CAPS UPGRADE

Upgrade to black, brushed brass, gunmetal or brushed bronze seat hinge cover caps for the following ranges.

Paradigm (PASCTS)

Faber Slim Seat (DC14078)

| | | |
|----------------|--------|--------|
| Black | DC4011 | £20.60 |
| Brushed brass | DC4012 | £35.60 |
| Gunmetal | DC4028 | £35.60 |
| Brushed bronze | DC4045 | £35.60 |

Widcombe Thermoset Seat (WSCTS-SF)

Elka Slim Seat (ELSLCTS-SF)

| | | |
|----------------|--------|--------|
| Black | DC4019 | £19.70 |
| Brushed brass | DC4020 | £33.90 |
| Gunmetal | DC4030 | £35.60 |
| Brushed bronze | DC4047 | £33.90 |

Hampton Seat (HAMSCTS-SF)

Aruba Seats (ARSCTS-SF, ARSLCTS-SF, ARSCTS2-SF)

Faber Wrapover Seat (DC14077-SF)

Elka Wrapover Seat (ELSCTS-SF)

| | | |
|----------------|--------|--------|
| Black | DC4032 | £19.70 |
| Brushed brass | DC4033 | £33.90 |
| Gunmetal | DC4034 | £35.60 |
| Brushed bronze | DC4046 | £33.90 |



DC4011



DC4028



DC4020



DC4047

FLUSH BUTTON UPGRADE FOR CISTERNS

Upgrade your close coupled cistern flush buttons to one of the finishes below.

Use the ø48mm button for the following ranges

- Hampton close coupled cistern p148
- Elka close coupled cistern p154
- Aruba close coupled cistern p156
- Paradigm close coupled cistern p158



ø48mm flush button cistern upgrade

| | | | | | |
|---------------|--------|--------|----------------|--------|--------|
| Black | TR9027 | £20.60 | Nickel | TR9056 | £25.80 |
| Brushed brass | TR9039 | £25.80 | Brushed bronze | TR9052 | £25.80 |
| Gunmetal | TR9048 | £25.80 | | | |

Use the ø38mm button and flush valve TR9033 (opposite) for the following ranges.

- Faber close coupled cistern p145



ø38mm flush button cistern upgrade

| | | | | | |
|---------------|--------|--------|----------------|--------|--------|
| Black | TR9026 | £20.60 | Nickel | TR9055 | £25.80 |
| Brushed brass | TR9038 | £25.80 | Brushed bronze | TR9051 | £25.80 |
| Gunmetal | TR9047 | £25.80 | | | |

OVERFLOW CAPS UPGRADE FOR BASINS

Upgrade your semi-countertop basin one of our overflow caps.

(Not suitable for Paradigm)



| | | |
|----------------|--------|--------|
| Black | OVMCBK | £11.30 |
| Brushed brass | OVMCA | £11.30 |
| Gunmetal | OVMCGM | £11.30 |
| Brushed nickel | OVMCBN | £11.30 |
| Brushed bronze | OVMCBZ | £11.30 |





TAPS & SHOWERS



Explore our tap & shower

COLLECTION

As specialists in what they do, our product designers are constantly looking for new ways to improve the showering experience. With an extensive range of contemporary designs and functions, we've developed a simple guide to help you choose the right one and get the most of your shower.

When it comes to taps, our wide range of styles mean you'll always find one to suit your taste. Why not take your design one step further and opt for coordinating taps and showers?

Discover

ROPER RHODES TAPS



FINISHES AND STYLES TO SUIT YOU

Discover taps to suit any space, with six stunning finishes from classic chrome to brushed bronze. Choose from basin mixers, bath shower mixers, and wall-mounted styles - combining function with flair.

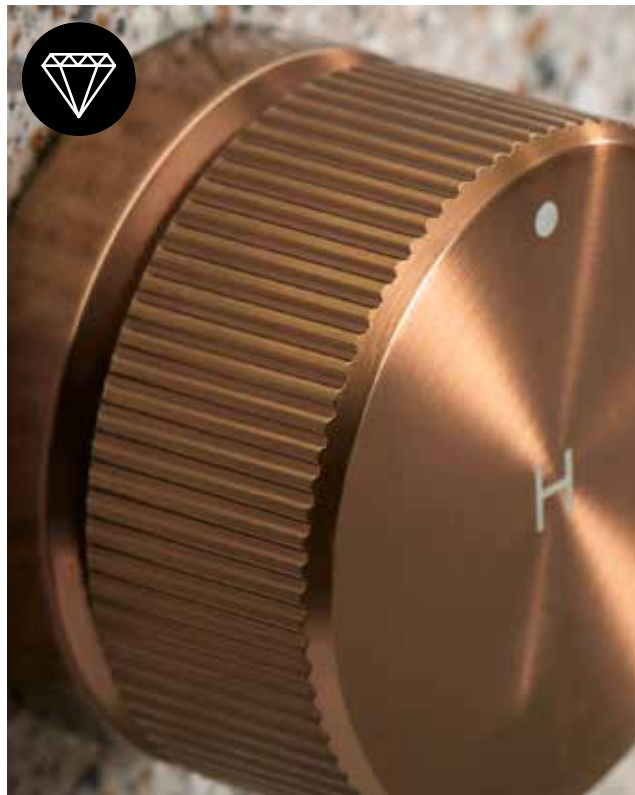

PVD TECHNOLOGY

PVD (Physical Vapour Deposition) coating on taps offers a durable, long-lasting finish that resists scratches, tarnishing, and corrosion. PVD-coated taps combine style with exceptional performance and reliability.



WHERE DESIGN MEETS PERFORMANCE

Our taps are designed to work around your needs. From the close detailing to the tactile features and tap design, our brassware is focussed on giving you the best performance.



QUALITY YOU CAN TRUST

Quality bathroom taps offer reliable performance, elegant design, and long-lasting comfort. With smooth operation, precise control, and drip-free ceramic disc technology, they're a smart choice for any style. Built to high standards and backed by guarantees, they're made to last



All Roper Rhodes taps come complete with a 10 year guarantee, including the cartridge, giving you complete confidence in making a Roper Rhodes tap part of your new bathroom experience.



EFFICIENCY IN EVERY DROP

Our water savers are designed to save water without compromising performance. They reduce water usage while maintaining a strong, steady stream. These taps are ideal for environmentally conscious homes, helping lower utility bills and conserve natural resources - all while adding a stylish touch to your bathroom.

Making the perfect choice

TAP BUYING GUIDE & FEATURES

Use the table below to guide you through our tap collection. Make your choice from the wide range of designs to suit both low & high pressure applications.

| | Basin mixer | Mini basin mixer (ideal for cloakrooms) | Tall basin mixer | Side action basin mixer | 3 hole basin mixer | Wall mounted basin mixer | Basin taps (pair) | Bath filler | Bath shower mixer with handset | Wall mounted bath shower mixer with handset | Freestanding bath shower mixer | Wall mounted spout | Stand pipes |
|------------|-------------|---|------------------|-------------------------|--------------------|--------------------------|-------------------|-------------|--------------------------------|---|--------------------------------|--------------------|-------------|
| Elan | ● | | ● | | ● | ● | | ● | ● | ● | | | |
| Faber | ● | ● | ● | | ● | ● | | ● | ● | | ● | ● | |
| Storm-Nova | ● | ● | ● | | | ● | | ● | ● | | ● | ● | |
| Metric | ● | ● | | | | | | ● | ● | | | | |
| Clear | ● | ● | | | | | | ● | ● | | | | |
| Walcot | ● | | | | ● | ● | | ● | ● | | | ● | |
| Wessex | ● | | | ● | ● | | | ● | ● | | | | ● |
| Keswick | ● | ● | | | ● | ● | ● | ● | ● | | | ● | ● |
| Cranborne | ● | | | | | | ● | ● | ● | | | | ● |
| Henley | ● | | | | | | ● | ● | ● | | | | ● |



GUARANTEE
10 year guarantee
including tap cartridge



LOW PRESSURE 1

Suitable for all plumbing systems including conventional gravity fed ones with a minimum 0.1bar pressure* and above



LOW PRESSURE 2

Suitable for all plumbing systems including conventional gravity fed ones with a minimum 0.2bar pressure* and above



MEDIUM PRESSURE

Suitable for all plumbing systems including conventional gravity fed or modern pressurised ones with a minimum 0.5bar pressure* and above



HIGH PRESSURE

Requires a minimum pressure of 1.0bar or above and are more suitable for modern pressurised plumbing systems



SWIVEL AERATOR

Allows the position of the running water to be moved



SWIVEL SPOUT

Allows the spout to be moved from side to side



LEVER ACTION CERAMIC TECHNOLOGY

A smooth, easy to use action giving accurate flow control



QUARTER TURN CERAMIC TECHNOLOGY

Quarter turn taps only require a 90° turn of the handle to move from fully open to closed



UNDER SPOUT DIVERTER

Located underneath the spout, turn to divert the water flow to use the shower or fill the bath. Easier to clean



10 YEAR GUARANTEE

All taps come with a 10 year guarantee, including the tap cartridge



PVD

A hardwearing and scratch resistant coating



CHROME3

Utilising Chrome3 electroplating, a more environmentally friendly process



ECO1

Compatible with our optional water and energy saving shower flow regulators



ECO2

Compatible with our optional water and energy saving basin tap flow regulators



ECO3

Compatible with our optional water and energy saving basin mixer flow regulators

*Bar pressure is a unit of measurement for pressure

0.1bar is equal to a metre head of water. In plumbing terms this means that for a gravity fed system, if the base height of your water tank is 1m above a tap, then you will have 0.1bar of pressure at the tap

Tap collection

ELAN



GUARANTEE
10 year guarantee
including tap
cartridge



ALSO
AVAILABLE IN
**BRUSHED
BRASS**
SEE PAGE 178



ELAN CHROME & BRUSHED NICKEL



Basin mixer with click waste
150(h) x 45(w) x 174(d)mm

| | | |
|----------------|---------|----------------|
| Chrome | T521102 | £375.00 |
| Brushed nickel | T521106 | £475.00 |



Basin tall mixer with click waste
281(h) x 45(w) x 210(d)mm

| | | |
|----------------|---------|----------------|
| Chrome | T525002 | £495.00 |
| Brushed nickel | T525006 | £595.00 |



**3 tap hole deck mounted mixer
(waste not included)**
140(h) x 195(d)mm

| | | |
|----------------|---------|----------------|
| Chrome | T527902 | £585.00 |
| Brushed nickel | T527906 | £725.00 |



**Wall mounted mixer
(waste not included)**
105(h) x 270(w) x 205(d)mm

| | | |
|----------------|---------|----------------|
| Chrome | T521902 | £655.00 |
| Brushed nickel | T521906 | £735.00 |



**5 hole deck mounted
bath shower mixer**
140(h) x 195(d)mm

| | | |
|----------------|---------|------------------|
| Chrome | T524202 | £1,250.00 |
| Brushed nickel | T524206 | £1,500.00 |



**5 hole wall mounted
bath shower mixer**
290(h) x 205(d)mm

| | | |
|----------------|---------|------------------|
| Chrome | T524402 | £1,250.00 |
| Brushed nickel | T524406 | £1,500.00 |



Tap collection

ELAN



GUARANTEE
10 year guarantee
including tap
cartridge





ELAN BRUSHED BRASS



Basin mixer with click waste
150(h) x 45(w) x 174(d)mm

Brushed brass T521104 **£475.00**



Basin tall mixer with click waste
281(h) x 45(w) x 210(d)mm

Brushed brass T525004 **£595.00**



3 tap hole deck mounted mixer
(waste not included)
140(h) x 195(d)mm

Brushed brass T527904 **£725.00**



Basin Bath
mixer filler



Wall mounted mixer
(waste not included)
105(h) x 270(w) x 205(d)mm

Brushed brass T521904 **£735.00**

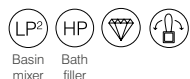

Basin Bath
mixer filler



**5 hole deck mounted
bath shower mixer**
140(h) x 195(d)mm

Brushed brass T524204 **£1,500.00**



**5 hole wall mounted
bath shower mixer**
290(h) x 205(d)mm

Brushed brass T524404 **£1,500.00**



Tap collection
FABER



GUARANTEE
10 year guarantee
including tap cartridge

ALSO
AVAILABLE IN
**NICKEL
& CHROME**
SEE PAGE 182



FABER BRUSHED BRONZE



Basin mixer with click waste
42(w) x 158(h) x 136(d)mm
Brushed bronze T501108 **£289.00**



Mini basin mixer with click waste
42(w) x 143(h) x 136(d)mm
Brushed bronze T506108 **£277.00**



Wall mounted mixer
255(w) x 68(h) x 185(d)mm
Brushed bronze T501908 **£325.00**



3 tap hole basin mixer with click waste
164(h) x 178(d)mm
Brushed bronze T507908 **£325.00**



Tall basin mixer (waste not included)
52(w) x 298(h) x 135(d)mm
Brushed bronze T505008 **£367.00**



Deck mounted bath filler
180(w) x 126(h) x 140(d)mm
Brushed bronze T503208 **£385.00**



Freestanding bath shower mixer
200(w) x 1125(h) x 365(d)mm
Brushed bronze T504308 **£1,110.00**

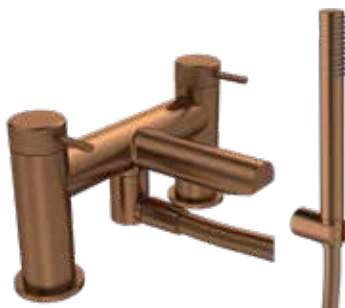

Deck mounted bath shower mixer
230(w) x 126(h) x 140(d)mm
Brushed bronze T504208 **£482.00**



Wall mounted spout
66(h) x 55(w) x 192(d)mm
Brushed bronze T501408 **£110.00**



COMPLETE YOUR SPACE

Match our Faber taps with Faber showers and accessories for a harmonious and refined bathroom collection. Faber concealed shower systems p222, bar valve shower systems p238 and p278 for accessories.

Tap collection
FABER



GUARANTEE
10 year guarantee
including tap cartridge

ALSO
AVAILABLE IN
BRONZE
SEE PAGE 180



FABER BRUSHED NICKEL & CHROME



Basin mixer with click waste
42(w) x 158(h) x 136(d)mm

| | | |
|----------------|---------|----------------|
| Chrome | T501102 | £192.50 |
| Brushed nickel | T501106 | £289.00 |



Mini basin mixer with click waste
42(w) x 143(h) x 136(d)mm

| | | |
|----------------|---------|----------------|
| Chrome | T506102 | £180.00 |
| Brushed nickel | T506106 | £277.00 |



Wall mounted mixer
255(w) x 68(h) x 185(d)mm

| | | |
|----------------|---------|----------------|
| Chrome | T501902 | £215.00 |
| Brushed nickel | T501906 | £325.00 |



3 tap hole basin mixer with click waste
164(h) x 178(d)mm

| | | |
|----------------|---------|----------------|
| Chrome | T507902 | £215.00 |
| Brushed nickel | T507906 | £325.00 |



Tall basin mixer (waste not included)
52(w) x 298(h) x 135(d)mm

| | | |
|----------------|---------|----------------|
| Chrome | T505002 | £243.00 |
| Brushed nickel | T505006 | £367.00 |



Deck mounted bath filler
180(w) x 126(h) x 140(d)mm

| | | |
|----------------|---------|----------------|
| Chrome | T503202 | £302.00 |
| Brushed nickel | T503206 | £385.00 |



Freestanding bath shower mixer
200(w) x 1125(h) x 365(d)mm

| | | |
|----------------|---------|------------------|
| Chrome | T504302 | £975.00 |
| Brushed nickel | T504306 | £1,110.00 |



Deck mounted bath shower mixer
230(w) x 126(h) x 140(d)mm

| | | |
|----------------|---------|----------------|
| Chrome | T504202 | £379.00 |
| Brushed nickel | T504206 | £482.00 |



Wall mounted spout
66(h) x 55(w) x 192(d)mm

| | | |
|----------------|---------|----------------|
| Chrome | T501402 | £90.00 |
| Brushed nickel | T501406 | £110.00 |



COMPLETE YOUR SPACE

Match our Faber taps with Faber showers and accessories for a harmonious and refined bathroom collection. Faber concealed shower systems p222, bar valve shower systems p238 and p278 for accessories.

Tap collection

STORM-NOVA



GUARANTEE
10 year guarantee
including tap cartridge

ALSO
AVAILABLE IN
BRASS
SEE PAGE 196



STORM-NOVA BLACK & CHROME



Basin mixer with click waste
42(w) x 158(h) x 136(d)mm

| | | |
|--------|---------|----------------|
| Chrome | T461102 | £192.50 |
| Black | T461103 | £238.00 |



Mini basin mixer with click waste
42(w) x 143(h) x 136(d)mm

| | | |
|--------|---------|----------------|
| Chrome | T466102 | £180.00 |
| Black | T466103 | £225.00 |



Tall basin mixer with click waste
52(w) x 298(h) x 135(d)mm

| | | |
|--------|---------|----------------|
| Chrome | T465002 | £243.00 |
| Black | T465003 | £305.00 |



Wall mounted basin mixer
160(w) x 120(h) x 180(d)mm

| | | |
|--------|---------|----------------|
| Chrome | T491902 | £192.50 |
| Black | T491903 | £255.00 |



Bath filler
230(w) x 126(h) x 140(d)mm

| | | |
|--------|---------|----------------|
| Chrome | T463202 | £302.00 |
| Black | T463203 | £322.00 |



Bath shower mixer
230(w) x 126(h) x 140(d)mm

| | | |
|--------|---------|----------------|
| Chrome | T464202 | £379.00 |
| Black | T464203 | £405.00 |



Freestanding bath shower mixer
200(w) x 1125(h) x 365(d)mm

| | | |
|--------|---------|------------------|
| Chrome | T461902 | £975.00 |
| Black | T461903 | £1,030.00 |



COMPLETE YOUR SPACE

Pair the Storm-Nova taps with a Unity shower system or Capital accessories for a seamless design. Unity concealed shower systems p226-229 and bar valve shower systems p240. Capital accessories p280.

Tap collection

STORM-NOVA



GUARANTEE
10 year guarantee
including tap cartridge

ALSO
AVAILABLE IN
**BLACK &
CHROME**
SEE PAGE 184



STORM-NOVA BRUSHED BRASS



Basin mixer with click waste
42(w) x 158(h) x 136(d)mm
Brushed brass T461104 **£289.00**



Mini basin mixer with click waste
42(w) x 143(h) x 136(d)mm
Brushed brass T466104 **£277.00**



Tall basin mixer with click waste
52(w) x 298(h) x 135(d)mm
Brushed brass T465004 **£367.00**



Wall mounted basin mixer
160(w) x 120(h) x 180(d)mm
Brushed brass T491904 **£305.00**



Bath filler
230(w) x 126(h) x 140(d)mm
Brushed brass T463204 **£385.00**



Bath shower mixer
230(w) x 126(h) x 140(d)mm
Brushed brass T464204 **£482.00**



Freestanding bath shower mixer
200(w) x 1125(h) x 365(d)mm
Brushed brass T461904 **£1,110.00**



COMPLETE YOUR SPACE

Pair the Storm-Nova taps with a Unity shower system or Capital accessories for a seamless design. Unity concealed shower systems p226-229 and bar valve shower systems p240. Capital accessories p280.

Tap collection

METRIC



GUARANTEE
10 year guarantee
including tap cartridge

AVAILABLE IN
BLACK,
CHROME
OR
BRASS



METRIC CHROME, BLACK, BRUSHED BRASS



Basin mixer with click waste
52(w) x 160(h) x 160(d)mm

| | | |
|---------------|---------|----------------|
| Chrome | T391102 | £238.00 |
| Black | T391103 | £283.00 |
| Brushed brass | T391104 | £312.00 |

Mini basin mixer with click waste
52(w) x 145(h) x 245(d)mm

| | | |
|---------------|---------|----------------|
| Chrome | T396102 | £225.00 |
| Black | T396103 | £270.00 |
| Brushed brass | T396104 | £300.00 |



Brushed brass finish only



Brushed brass finish only



Bath filler
230(w) x 122(h) x 150(d)mm

| | | |
|---------------|---------|----------------|
| Chrome | T393202 | £360.00 |
| Black | T393203 | £385.00 |
| Brushed brass | T393204 | £436.00 |

Bath shower mixer
230(w) x 122(h) x 150(d)mm

| | | |
|---------------|---------|----------------|
| Chrome | T394202 | £431.00 |
| Black | T394203 | £450.00 |
| Brushed brass | T394204 | £510.00 |

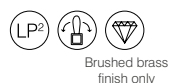

Brushed brass finish only



Brushed brass finish only



COMPLETE YOUR SPACE

Pair the Metric taps with a Recite shower system or Restore accessories for a seamless design. Recite concealed shower systems p230 and bar valve shower systems p242. Restore accessories p281.

Tap collection
CLEAR



GUARANTEE
10 year guarantee
including tap cartridge

CLEAR



Basin mixer with click waste
54(w) x 173(h) x 160(d)mm
Chrome T361102 **£229.00**



Mini basin mixer with click waste
54(w) x 151(h) x 146(d)mm
Chrome T366102 **£215.00**



Bath filler
232(w) x 135(h) x 159(d)mm
Chrome T363202 **£359.00**



Bath shower mixer
232(w) x 135(h) x 159(d)mm
Chrome T364202 **£430.00**



COORDINATING SHOWERS

Pair the Clear taps with a coordinating Clear shower system for a seamless design in your bathroom. See page 233 for the complete range of Clear showers.

Tap collection
WALCOT

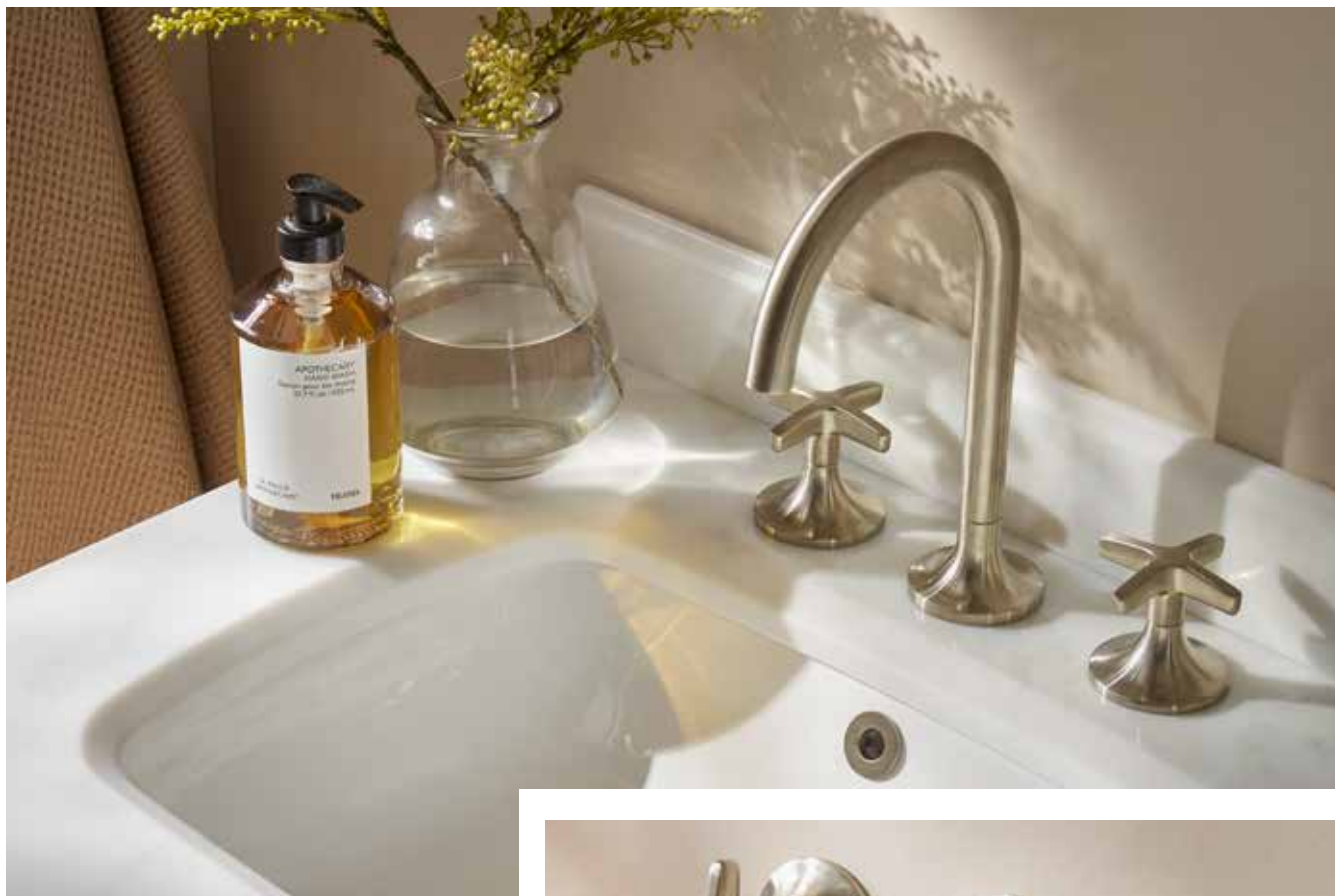

GUARANTEE
10 year guarantee
including tap cartridge



Basin mixer with click waste
265(h) x 168(w) x 168(d)mm

T511106 **£335.00**



3 hole basin mixer with click waste
241(h) x 180(d)mm

T517906 **£340.00**



Wall mounted mixer
(waste not included)
72(h) x 275(w) x 228(d)mm

T511906 **£335.00**



Bath filler
284(h) x 180(w) x 198(d)mm

T513206 **£595.00**



Bath shower mixer
284(h) x 180(w) x 198(d)mm

T514206 **£750.00**



Wall mounted bath spout
66(h) x 60(w) x 192(d)mm

T511406 **£110.00**



COMPLETE YOUR SPACE

Match our Walcot taps with coordinating Walcot showers and accessories for a harmonious and refined bathroom collection. Walcot concealed shower systems on p248, bar valve shower systems on p236, and accessories on p279.

Tap collection
WALCOT



GUARANTEE
10 year guarantee
including tap cartridge



Basin mixer with click waste
265(h) x 168(w) x 168(d)mm
T511104 **£335.00**



3 hole basin mixer with click waste
241(h) x 180(d)mm
T517904 **£340.00**



**Wall mounted mixer
(waste not included)**
72(h) x 275(w) x 228(d)mm
T511904 **£335.00**



Basin mixer Bath filler



Bath filler
284(h) x 180(w) x 198(d)mm
T513204 **£595.00**



Bath shower mixer
284(h) x 180(w) x 198(d)mm
T514204 **£750.00**



Wall mounted bath spout
66(h) x 60(w) x 192(d)mm
T511404 **£110.00**



COMPLETE YOUR SPACE

Match our Walcot taps with coordinating Walcot showers and accessories for a harmonious and refined bathroom collection. Walcot concealed shower systems on p250, bar valve shower systems on p236, and accessories on p279.

Tap collection

KESWICK



GUARANTEE
10 year guarantee
including tap cartridge

KESWICK TIMELESS BRUSHED BRASS

A timeless brushed brass finish, crafted in a slightly darker brass shade for a richer, refined look.



ALSO AVAILABLE IN CHROME
SEE PAGE 198



Basin mixer with click waste
168(w) x 200(h) x 160(d)mm
T321104 **£323.00**



Basin taps (waste not included)
46(w) x 124(h) x 125(d)mm
T327004 **£220.50**



Basin mono basin mixer with click waste
62(w) x 162(h) x 160(d)mm
T322504 **£305.00**



Mini mono basin mixer with click waste
62(w) x 140(h) x 148mm(d)
T326104 **£284.00**



3 hole basin mixer with click waste
290(w) x 146(h) x 155mm(d)
T327904 **£317.00**



Wall mounted mixer (waste not included)
252(w) x 135(h) x 135mm(d)
T321904 **£317.00**



Basin mixer Bath filler



Bath filler
237(w) x 200(h) x 213(d)mm
T323204 **£570.00**



Bath shower mixer
237(w) x 375(h) x 213(d)mm
T324204 **£740.00**



STAND PIPES

For the ultimate timeless style, why not add standpipes to your traditional bath filler or bath shower mixer? Finished in timeless brushed brass, these standpipes are thoughtfully designed to complement the rest of the Keswick collection.



Wall mounted bath spout
50(w) x 90(h) x 200(d)mm
T151404 **£110.00**



Stand pipes
87(w) x 680(d)mm
T262104 **£600.00**



COMPLETE YOUR SPACE

Match our Keswick taps with coordinating Keswick showers and accessories for a harmonious and refined bathroom collection. Keswick shower systems on p252 and accessories on p282.

Tap collection

KESWICK



GUARANTEE
10 year guarantee
including tap cartridge



ALSO AVAILABLE IN
TIMELESS
BRUSHED
BRASS
SEE PAGE 196



Basin mixer with click waste
168(w) x 200(h) x 160(d)mm
T321102 **£229.00**



Basin taps (waste not included)
46(w) x 124(h) x 125(d)mm
T327002 **£143.50**



Basin mono basin mixer with click waste
62(w) x 162(h) x 160(d)mm
T322502 **£215.00**



Mini mono basin mixer with click waste
62(w) x 140(h) x 148mm(d)
T326102 **£198.50**



3 hole basin mixer with click waste
290(w) x 146(h) x 155mm(d)
T327902 **£225.00**



Wall mounted mixer (waste not included)
252(w) x 135(h) x 135mm(d)
T321902 **£225.00**



Bath filler
237(w) x 200(h) x 213(d)mm
T323202 **£430.00**



Bath shower mixer
237(w) x 375(h) x 213(d)mm
T324202 **£570.00**



STAND PIPES

For the ultimate timeless style, why not add stand pipes to your traditional style bath filler or bath shower mixer? The stand pipes are compatible with Wessex, Keswick, Cranborne and Henley ranges only.



Wall mounted bath spout
50(w) x 90(h) x 200(d)mm
T151402 **£90.00**

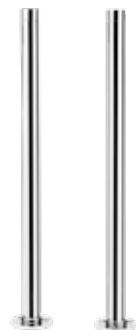

Stand pipes
87(w) x 680(d)mm
T262102 **£550.00**



COMPLETE YOUR SPACE

Match our Keswick taps with coordinating Keswick showers and accessories for a harmonious and refined bathroom collection. Keswick shower systems on p254 and accessories on p282.

Tap collection

WESSEX



GUARANTEE
10 year guarantee
including tap cartridge



Basin mixer with click waste
218(w) x 275(h) x 180(d)mm
Chrome T661002 **£309.00**



3 hole basin mixer with click waste
310(w) x 150(h) x 180(d)mm
Chrome T667902 **£287.00**



Side action basin mixer
93(w) x 345(h) x 230(d)mm
Chrome T661602 **£287.00**



Bath filler
250(w) x 254(h) x 194(d)mm
Chrome T663202 **£461.00**



Bath shower mixer
250(w) x 254(h) x 194(d)mm
Chrome T664202 **£565.00**



STAND PIPES

For the ultimate timeless style, why not add stand pipes to your traditional style bath filler or bath shower mixer? The stand pipes are compatible with Wessex, Keswick, Cranborne and Henley ranges only.



Stand pipes
87(w) x 680(d)mm
Chrome T262102 **£550.00**

Tap collection

CRANBORNE



GUARANTEE
10 year guarantee
including tap cartridge

CRANBORNE



Basin mixer with click waste
190(w) x 192(h) x 170(d)mm
Chrome T311102 **£229.00**



Basin taps (waste not included)
60(w) x 144(h) x 130(d)mm
Chrome T317002 **£143.50**



COORDINATING SHOWERS

Pair the Cranborne taps with a Cranborne shower system for a seamless design in your bathroom. Cranborne concealed and surface mounted systems p256 available.

STAND PIPES

For the ultimate timeless style, why not add stand pipes to your traditional style bath filler or bath shower mixer? The stand pipes are compatible with Wessex, Keswick, Cranborne and Henley ranges only.



Bath filler
237(w) x 200(h) x 213(d)mm
Chrome T313202 **£430.00**



Bath shower mixer
237(w) x 375(h) x 213(d)mm
Chrome T314202 **£570.00**



Stand pipes
87(w) x 680(d)mm
Chrome T262102 **£550.00**

Tap collection

HENLEY



GUARANTEE
10 year guarantee
including tap cartridge

HENLEY



Basin mixer with click waste
224(w) x 117(h) x 167(d)mm
Chrome T261102 **£228.00**



Basin taps (waste not included)
48(w) x 127(h) x 123(d)mm
Chrome T267002 **£140.00**



Bath filler
207(w) x 188(h) x 249(d)mm
Chrome T263202 **£370.00**



Bath shower mixer
207(w) x 372(h) x 249(d)mm
Chrome T264202 **£525.00**



COORDINATING SHOWERS

Pair the Henley taps with a Henley shower system for a seamless design in your bathroom. Henley concealed and surface mounted systems p258 available.

STAND PIPES

For the ultimate timeless style, why not add stand pipes to your traditional style bath filler or bath shower mixer? The stand pipes are compatible with Wessex, Keswick, Cranborne and Henley ranges only.



Stand pipes
87(w) x 680(d)mm
Chrome T262102 **£550.00**

WASTES

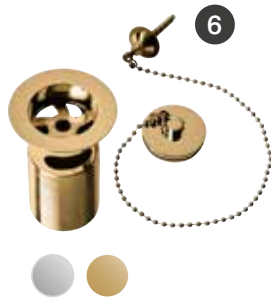

Universal click basin wastes are suitable for a variety of basin types. The waste body is comprised of two parts making it adjustable in depth.



Universal open basin wastes have a fixed open waste cover which ensures water flows from the basin at all times. Suitable for basins without an integrated overflow.

| Description | Code | Price |
|---|---------|--------|
| 1. Unslotted click waste 75mm body | WASTE6 | £29.40 |
| 2. Slotted click waste* 75mm body | WASTE7 | £29.40 |
| 3. Black slotted click waste 75mm body | WASTE12 | £31.80 |
| 4. Dome top click waste 75mm body | WASTE10 | £31.80 |
| 5. Slotted click waste 100mm body | WASTE9 | £35.60 |
| 6. Plug & chain waste (Suitable for two tap hole basins) | | |
| Chrome | WASTE11 | £33.90 |
| Brushed brass | WASTE14 | £39.20 |
| 7. Pop up cable bath waste 670mm length | WASTE20 | £56.80 |
| 8. 670mm length click waste* | | |
| Chrome | WASTE21 | £43.40 |
| Black | WASTE22 | £50.80 |
| Brushed brass | WASTE23 | £67.20 |
| Gunmetal | WASTE31 | £67.20 |
| Brushed bronze | WASTE36 | £67.20 |
| Brushed nickel | WASTE34 | £67.20 |
| 9. Universal click basin waste | | |
| Chrome | WASTE24 | £33.60 |
| Black | WASTE25 | £35.40 |
| Brushed brass | WASTE26 | £39.20 |
| Gunmetal | WASTE32 | £39.20 |
| Brushed bronze | WASTE39 | £39.20 |
| Brushed nickel | WASTE37 | £39.20 |
| 10. Universal open basin waste For use on basins without an overflow | | |
| Chrome | WASTE27 | £33.60 |
| Black | WASTE28 | £35.40 |
| Brushed brass | WASTE29 | £39.20 |
| Gunmetal | WASTE33 | £39.20 |
| Brushed bronze | WASTE42 | £39.20 |
| Brushed nickel | WASTE40 | £39.20 |



* Includes removable
easi-clean mechanism

WASTES & TRAPS



PVD
PVD hardwearing
& scratch resistant
coating. Brushed
finishes only



| Description | Code | Price |
|--|--------|---------|
| 1. Low profile trap | TRAP10 | £49.90 |
| 2. Standard bottle trap 45(h)mm adjustment range | TRAP2 | £39.20 |
| 3. Adjustable bottle trap 120(h)mm adjustment range | | |
| Chrome | TRAP6 | £77.60 |
| Black | TRAP7 | £95.20 |
| Brushed brass | TRAP8 | £112.50 |
| Gunmetal | TRAP11 | £112.50 |
| Brushed bronze | TRAP14 | £112.50 |
| Brushed nickel | TRAP12 | £112.50 |

WATER SAVING FLOW REGULATORS

Our range of optional regulators and aerators are an easy, cost effective way you help save water. These can be used with selected Roper Rhodes products to help reduce your water consumption.



ECO1 SHOWER WATER SAVERS

Suitable for showers & bath shower mixers displaying the ECO1 icon



6 litres/min
FR01



8 litres/min
FR02



10 litres/min
FR03

£11.40
each

- Mount between the valve & hose for shower valves with handsets or your bath shower mixer
- Mount between head and arm on your fixed shower heads
- We do not recommend the use of regulators with bath taps or fillers as you will want your bath to fill as quickly as possible



ECO3 BASIN MIXER WATER SAVERS

Suitable for taps displaying ECO3 icon



1.7 litres/min
FR04



3.5 litres/min
FR05



5 litres/min
FR06

£10.10
each

- Produce aerated water flow
- Simple to install into the aerator housing of basin mixer
- Available in a range of flow ratings

Basin mixer water savers include a chrome plated housing as standard. For black and brushed brass taps order an additional housing below.

Black SP21477 £3.80

Brushed brass SP21478 £3.80



ECO2 BASIN TAP WATER SAVERS

Suitable for pairs of taps displaying the ECO2 icon



3 litres/min
FR07



5 litres/min
FR08



7 litres/min
FR09

£4.90
each

- Install into the inlet of the tap
- One required for each tap, therefore please purchase in pairs
- Available in a range of flow ratings

Discover

ROPER RHODES SHOWERS

Discover our extensive collection of showering solutions. We at Roper Rhodes have put together a selection of shower systems to provide the ultimate showering experience, fitted out with the latest technology, our products not only look the part but will enhance your everyday bathroom experience.



Selective

Our Showering Solutions

Unearth the variety of shower valve functions & styles available in the Roper Rhodes range. p208

Intuitive

Concealed Push Button Showers

Ergonomic controls allow you to change the showering function at the push of a button. p212

Minimalist

Concealed Valve Showers

Valves installed behind the wall, perfect for a clean, modern bathroom space. p220



10 YEAR GUARANTEE

All Roper Rhodes shower systems come complete with a 10 year guarantee, including the thermostatic cartridge.



Timeless

Surface Mounted Showers

Make a statement with our beautifully designed, easy to install surface mounted showers, perfect for classically styled bathrooms. p246



Functional

Bar Showers

Easy to install contemporary surface mounted bar showers. Intuitive, easy to use controls allow you to regulate the water pressure and temperature. p234



Unique

Create Your Own Shower

Create a truly bespoke shower for your perfect bathroom tranquility. p260

Discover

UNDERSTANDING YOUR SHOWERING OPTIONS



EXPOSED SHOWER VALVES

Bring the charm of traditional brassware into your home. Our timeless collection of surface mounted showers pair the period style you love with our tried and tested engineering, giving you that vintage feel with the comfort that your shower will last for years to come.

BAR SHOWERS

Occupying slightly less area than traditional exposed valves, bar valves are an economical choice that are ideal for compact shower spaces. Exceptionally easy to install and maintain, our collection of bar style mixer shower valves are available with a classic single function handset, or as a dual function system with a rainfall effect showerhead. Available in smooth, round or sleek square designs.



PUSH BUTTON SHOWER VALVES

Making the everyday task luxurious. Swiss engineering combines with intelligent push button technology to offer you effortlessly luxurious showering, all at the touch of a button. Available in an expansive range of styles and configurations.



CONCEALED SHOWER VALVES

Our concealed thermostatic shower valves offer single, dual or triple function, all in one easy to control system. Single function allows you to choose your temperature level, dual function allows you to seamlessly switch between handset and overhead showers, whilst triple function adds our smart flow bath filler. Both include a specific handle to control the temperature, meaning you can choose your perfect level and leave it for the next time you shower.



10 YEAR GUARANTEE

All Roper Rhodes shower systems come complete with a 10 year guarantee, including the thermostatic cartridge.



PVD

PVD hardwearing & scratch resistant coating. Brushed brass finish



GUARANTEE including thermostatic cartridge

Making things simple

CONCEALED PUSH BUTTON SHOWERS

Push button shower systems are the perfect family showering solution, the ergonomic controls allow you to change the showering function at the push of a button. Our Event-click showers are easy to operate and the ideal solution for the modern bathroom. The shower handset features 3 invigorating spray functions, energising, relaxed and massage, providing you with the ultimate choice for relaxation. The separate thermostatic control dial means you can set your desired temperature which keeps it constant for every shower.



EASY INSTALLATION

The valve can be easily removed and serviced even after installation giving you total peace of mind.



Scan the QR code to see Event-Click shower features in action





Concealed push button shower solutions

EVENT-CLICK SHOWERS



Event-click single function shower system with smartflow bath filler

SVSET154 Chrome £510.00

Separate flow and temperature controls including on/off button
Anti-Scald thermostatic control for safe showering
Smartflow bath overflow filler
Min pressure 1.0bar

Event-click single function shower system with riser kit

SVSET155 Chrome £620.00

Separate flow and temperature controls including on/off button
120mm 3 function shower handset
Anti-Scald thermostatic control for safe showering
Adjustable riser rail brackets to suit existing wall fixings
Includes easy fix brass shower arm and elbow
Min pressure 1.0bar

Event-click dual function shower system with riser kit & overhead shower

SVSET157 Chrome £855.00

Separate flow and temperature controls including on/off button
230mm overhead shower
120mm 3 function shower handset
Anti-Scald thermostatic control for safe showering
Height adjustable riser rail
Includes easy fix brass shower arm and elbow
Min pressure 1.0bar

Event-click dual function shower system with riser kit & overhead shower

SVSET147 Chrome £855.00

Separate flow and temperature controls including on/off button
230mm overhead shower
120mm 3 function shower handset
Anti-Scald thermostatic control for safe showering
860mm long riser rail
Includes easy fix brass shower arm and elbow
Min pressure 1.0bar

SINGLE FUNCTION
Push button shower systems

DUAL FUNCTION
Push button shower systems

SHOWER HANDSET
3 different spray functions, energising, relaxed and massage, you're only one click away from total relaxation





PVD
PVD hardwearing
& scratch resistant
coating. Brushed
brass finish



**Event-click dual function
shower system with riser kit
& overhead shower**

| | | |
|----------|------------------|-----------|
| SVSET170 | Black | £960.00 |
| SVSET205 | Brushed brass | £1,080.00 |

Separate flow and temperature controls
including on/off button
250mm overhead shower
120mm 3 function shower handset
Anti-Scald thermostatic control for
safe showering
Height adjustable riser rail
Includes easy fix brass shower arm
and elbow
Min pressure 1.0bar



Concealed push button shower solutions

EVENT-CLICK SHOWERS

10
YEAR

GUARANTEE
including
thermostatic
cartridge

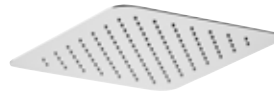

Event-click dual function shower system with handset, holder & overhead shower

SVSET164 Black £945.00

SVSET206 Brushed brass £1,040.00

Separate flow and temperature controls including on/off button
250mm overhead shower
120mm 3 function shower handset
Anti-Scald thermostatic control for safe showering
Includes easy fix brass shower arm and elbow
Min pressure 1.0bar

Event-click dual function shower system with handset, holder & overhead shower

SVSET156 Chrome £840.00

Separate flow and temperature controls including on/off button
230mm overhead shower
120mm 3 function shower handset
Anti-Scald thermostatic control for safe showering
Includes easy fix brass shower arm and elbow
Min pressure 1.0bar

Event-click dual function shower system with handset, holder & ceiling mounted overhead shower

SVSET162 Chrome £995.00

Separate flow and temperature controls including on/off button
300mm ceiling mounted overhead shower
120mm 3 function shower handset
Anti-Scald thermostatic control for safe showering
Includes easy fix brass shower arm and elbow
Min pressure 1.0bar

Event-click triple function shower system with riser kit, overhead shower & smartflow bath filler

SVSET159 Chrome £1,280.00

Separate flow and temperature controls including on/off button
230mm overhead shower
120mm 3 function shower handset
Anti-Scald thermostatic control for safe showering
Adjustable riser rail brackets to suit existing wall fixings
Includes easy fix brass shower arm and elbow
Smartflow bath overflow filler
Min pressure 1.0bar

DUAL FUNCTION
Push button shower systems



SMARTFLOW BATH FILLER
Use in place of a tap on your bath tub for a sleek, minimalist bath filling solution



PVD
PVD hardwearing
& scratch resistant
coating. Brushed
brass finish



Event-click triple function shower system with handset, holder, overhead shower & smartflow bath filler

SVSET158 Chrome **£1,240.00**

Separate flow and temperature controls including on/off button
230mm overhead shower
120mm 3 function shower handset
Anti-Scald thermostatic control for safe showering
Includes easy fix brass shower arm and elbow
Smartflow bath overflow filler
Min pressure 1.0bar

Event-click triple function shower system with handset, holder, overhead shower & smartflow bath filler

SVSET204 Black **£1,290.00**

Separate flow and temperature controls including on/off button
250mm overhead shower
120mm 3 function shower handset
Anti-Scald thermostatic control for safe showering
Includes easy fix brass shower arm and elbow
Smartflow bath overflow filler
Min pressure 1.0bar

SVSET207 Brushed **£1,450.00**
brass

TRIPLE FUNCTION
Push button shower systems



Concealed push button valve solutions
EVENT-CLICK VALVES

Push button shower valves feature easy to use controls, they benefit from instant start/stop activation for up to 3 outlets. Their concealed styling offer a stunning minimalist design solution. The round handle controls the temperature (which you can set and leave, ensuring the perfect temperature each time you shower). The buttons control the chosen outlets. Push button valves are only available within the Event-click collection.



10
YEAR
GUARANTEE
 including
 thermostatic
 cartridge



PVD
 PVD hardwearing
 & scratch resistant
 coating. Brushed
 brass finish



Event-click single function shower valve
 95(w) x 161mm(h)
 Minimum pressure 1.0bar

| | | |
|--------|--------|----------------|
| SV3216 | Chrome | £413.00 |
|--------|--------|----------------|



Event-click dual function shower valve
 95(w) x 222mm(h)
 Minimum pressure 1.0bar

| | | |
|----------|---------------|----------------|
| SV3214 | Chrome | £535.00 |
| SV3218 | Black | £645.00 |
| SV321404 | Brushed brass | £740.00 |



Event-click triple function shower valve
 102(w) x 268mm(h)
 Minimum pressure 1.0bar

| | | |
|----------|---------------|----------------|
| SV3217 | Chrome | £765.00 |
| SV321703 | Black | £860.00 |
| SV321704 | Brushed brass | £965.00 |

Spare push button with a bath filling symbol supplied with dual function shower valve

**COMPLETE CONTROL
AT THE PUSH OF A BUTTON**

Control your shower or bath with just one push of a button. Our valve options give you flexibility and choice with how many functions you want your shower to control, you can even use our valves to fill your bath when paired with a bath filler, see page 276 for bath filling solutions

VALVES CAN BE MOUNTED HORIZONTALLY OR VERTICALLY



CONTROL

Use the dial to preset your shower temperature, ensuring you get the perfect showering experience every time

FUNCTION

Choose your preferred shower function at the click of a button



SINGLE FUNCTION

Single function valve allows for the control of 1 shower accessory such as a fixed shower head



DUAL FUNCTION

Dual function valve allows for the control of 2 separate shower accessories such as a shower handset and fixed shower head



TRIPLE FUNCTION

Triple function valve allows for control of 3 separate shower accessories such as a shower handset, fixed shower head & smartflow bath filler

Making things simple

CONCEALED VALVE SHOWERS

Our concealed shower offer two or three functions with a rainfall overhead shower, an elegant shower handset and smartflow bath filler. The classic riser rail style allows you to adjust the height of your handset with ease for optimal showering. These showers are available in round or square styles.



GUARANTEE
including
thermostatic
cartridge



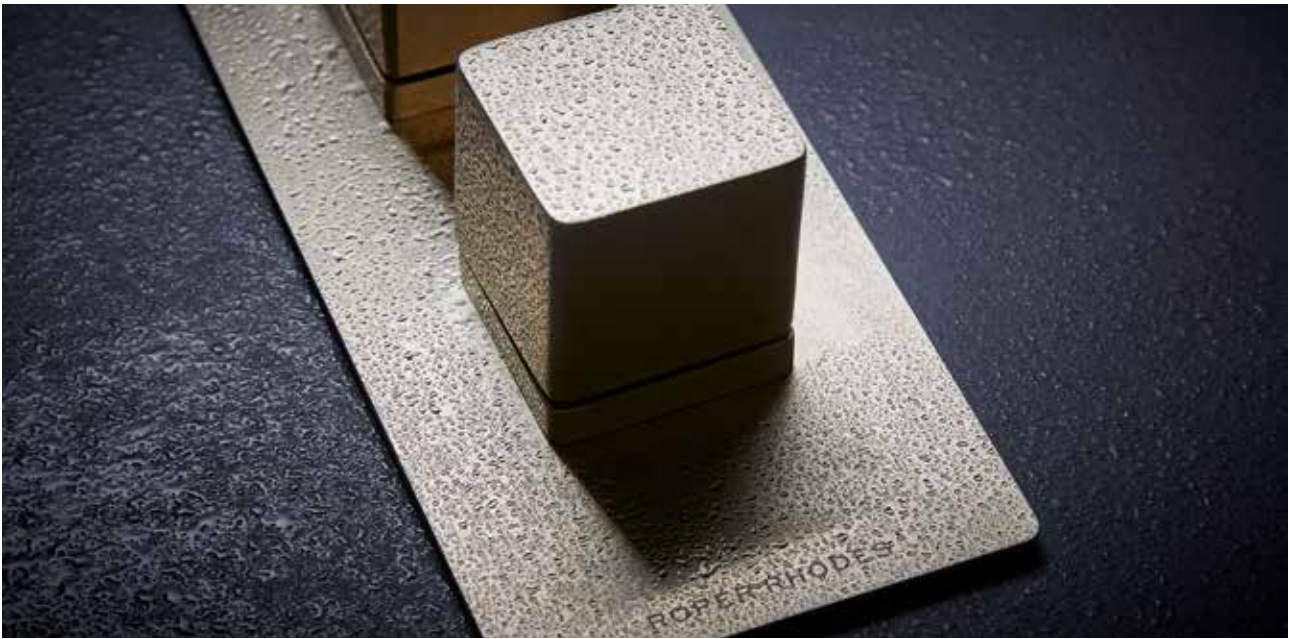

Concealed shower solutions

FABER SHOWERS



PVD
PVD hardwearing
& scratch resistant
coating. Brushed
finishes only



ECO¹
Compatible with
optional water &
energy saving flow
regulators



GUARANTEE
including
thermostatic
cartridge



ALSO
AVAILABLE IN
BRUSHED
NICKEL
SEE PAGE
224



FABER VALVE HANDLE



Faber dual function shower system with outlet riser kit & overhead shower

| | | |
|----------|----------------|-----------|
| SVSET208 | Chrome | £700.00 |
| SVSET210 | Brushed bronze | £1,100.00 |

Separate flow and temperature controls
250mm overhead shower
Single function shower handset
Anti-Scald thermostatic control for safe showering
Riser rail includes outlet
Includes easy fix brass shower arm and riser outlet
1.5m easy clean smooth shower hose
Min pressure 1.0bar

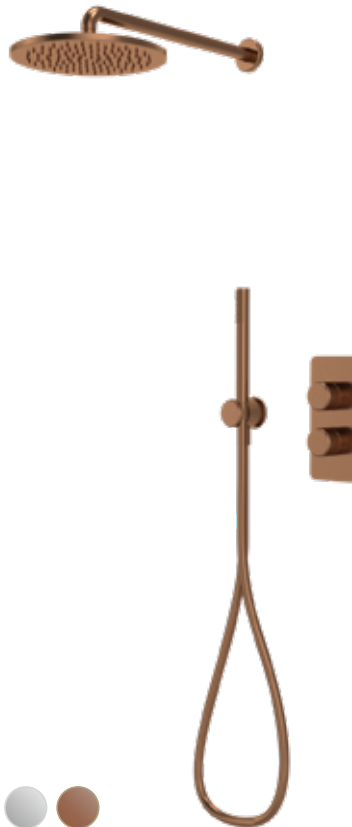

Faber dual function shower system with overhead shower & handset outlet

| | | |
|----------|----------------|---------|
| SVSET211 | Chrome | £625.00 |
| SVSET213 | Brushed bronze | £995.00 |

Separate flow and temperature controls
250mm overhead shower
Single function shower handset
Anti-Scald thermostatic control for safe showering
Includes easy fix brass shower arm and elbow
1.5m easy clean smooth shower hose
Min pressure 1.0bar

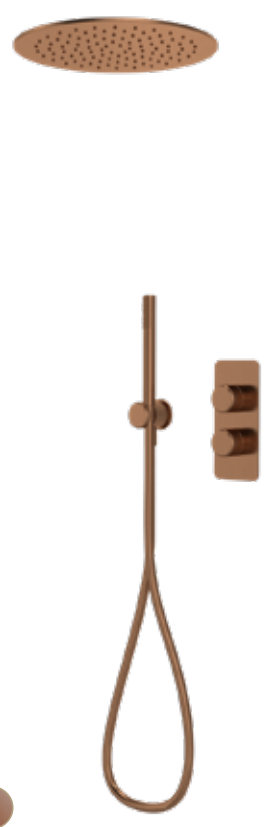

Faber dual function shower system with ceiling head & handset outlet

| | | |
|----------|----------------|---------|
| SVSET214 | Chrome | £625.00 |
| SVSET216 | Brushed bronze | £995.00 |

Separate flow and temperature controls
300mm ceiling shower
Single function shower handset
Anti-Scald thermostatic control for safe showering
Includes easy fix brass elbow
1.5m easy clean smooth shower hose
Min pressure 1.0bar



Faber dual function shower valve

| | | |
|----------|----------------|---------|
| SV5009 | Chrome | £400.00 |
| SV500908 | Brushed bronze | £700.00 |

220(h) x 100(w)mm
Dual function minimum pressure 1.0bar



COMPLETE YOUR SPACE

Match our Faber showers with Faber taps and accessories for a harmonious and refined bathroom collection. See p180 for taps and p278 for accessories.



Concealed shower solutions

FABER SHOWERS



PVD
PVD hardwearing
& scratch resistant
coating. Brushed
finishes only



ECO¹
Compatible with
optional water &
energy saving flow
regulators



GUARANTEE
including
thermostatic
cartridge

ALSO
AVAILABLE IN
BRUSHED
BRONZE &
CHROME
SEE PAGE
222



FABER VALVE HANDLE





Faber dual function shower system with outlet riser kit & overhead shower

SVSET209 Brushed nickel **£1,100.00**

Separate flow and temperature controls
250mm overhead shower
Single function shower handset
Anti-Scald thermostatic control for safe showering
Riser rail includes outlet
Includes easy fix brass shower arm and riser outlet
1.5m easy clean smooth shower hose
Min pressure 1.0bar



Faber dual function shower system with overhead shower & handset outlet

SVSET212 Brushed nickel **£995.00**

Separate flow and temperature controls
250mm overhead shower
Single function shower handset
Anti-Scald thermostatic control for safe showering
Includes easy fix brass shower arm and elbow
1.5m easy clean smooth shower hose
Min pressure 1.0bar



Faber dual function shower system with ceiling head & handset outlet

SVSET215 Brushed nickel **£995.00**

Separate flow and temperature controls
300mm ceiling shower
Single function shower handset
Anti-Scald thermostatic control for safe showering
Includes easy fix brass elbow
1.5m easy clean smooth shower hose
Min pressure 1.0bar



Faber dual function shower valve

SV500906 Brushed nickel **£700.00**

220(h) x 100(w)mm
Dual function minimum pressure 1.0bar



COMPLETE YOUR SPACE

Match our Faber showers with Faber taps and accessories for a harmonious and refined bathroom collection. See p182 for taps and p278 for accessories.



Concealed shower solutions

UNITY SHOWERS



PVD
PVD hardwearing
& scratch resistant
coating. Brushed
finishes only



ECO1
Compatible with
optional water &
energy saving flow
regulators



GUARANTEE
including
thermostatic
cartridge



UNITY VALVE HANDLE



AVAILABLE IN
CHROME
BLACK
OR
BRASS



Unity dual function shower system with riser kit & overhead shower

| | | |
|----------|---------------|----------------|
| SVSET151 | Chrome | £575.00 |
| SVSET152 | Black | £675.00 |
| SVSET173 | Brushed brass | £985.00 |

Separate flow and temperature controls
 250mm stainless steel overhead shower
 120mm 3 function push button control shower handset
 Anti-Scald thermostatic control for safe showering
 Adjustable riser rail brackets to suit existing wall fixings
 Includes easy fix brass shower arm and elbow
 Min pressure 0.5bar



Unity dual function shower system with handset, holder & overhead shower

| | | |
|----------|---------------|----------------|
| SVSET189 | Chrome | £535.00 |
| SVSET190 | Black | £640.00 |
| SVSET191 | Brushed brass | £955.00 |

Separate flow and temperature controls
 250mm stainless steel overhead shower
 Single function slim handset
 Anti-Scald thermostatic control for safe showering
 Includes easy fix brass shower arm and elbow
 Min pressure 0.5bar



Unity dual function shower system with handset, holder & ceiling mounted overhead shower

| | | |
|----------|---------------|----------------|
| SVSET192 | Chrome | £535.00 |
| SVSET193 | Black | £640.00 |
| SVSET194 | Brushed brass | £955.00 |

Separate flow and temperature controls
 250mm stainless steel overhead shower
 Single function slim handset
 Anti-Scald thermostatic control for safe showering
 Min pressure 0.5bar

DUAL FUNCTION
 Concealed shower systems

Concealed shower solutions

UNITY SHOWERS



PVD
PVD hardwearing
& scratch resistant
coating. Brushed
finishes only



ECO1
Compatible with
optional water &
energy saving flow
regulators



GUARANTEE
including
thermostatic
cartridge



AVAILABLE IN
CHROME
BLACK
OR
BRASS



UNITY VALVE HANDLE



Unity triple function shower system with riser kit, overhead shower & smartflow bath filler

| | | |
|----------|---------------|------------------|
| SVSET195 | Chrome | £810.00 |
| SVSET196 | Black | £885.00 |
| SVSET197 | Brushed brass | £1,290.00 |

Separate flow and temperature controls
 250mm stainless steel overhead shower
 120mm 3 function push button control shower handset
 Anti-Scald thermostatic control for safe showering
 Adjustable riser rail brackets to suit existing wall fixings
 Includes easy fix shower arm and elbow
 Smartflow bath overflow filler
 Min pressure 1.0bar

TRIPLE FUNCTION
 Concealed shower system



SMARTFLOW BATH FILLER
 Use in place of a tap on your bath tub for a sleek, minimalist bath filling solution

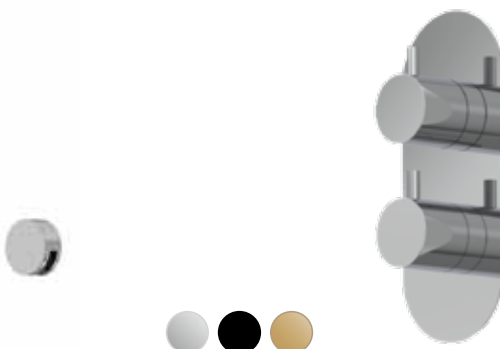

Unity single function valve

| | | |
|----------|---------------|----------------|
| SV3904 | Chrome | £284.00 |
| SV390403 | Black | £412.00 |
| SV390404 | Brushed brass | £635.00 |

Unity dual function valve

| | | |
|--------|---------------|----------------|
| SV3906 | Chrome | £319.00 |
| SV3915 | Black | £445.00 |
| SV3919 | Brushed brass | £675.00 |

90(w) x 215mm(h)
 Minimum pressure 0.5bar



Unity triple function valve

| | | |
|----------|---------------|----------------|
| SV3909 | Chrome | £535.00 |
| SV390903 | Black | £665.00 |
| SV390904 | Brushed brass | £880.00 |

90(w) x 295mm(h)
 Minimum pressure 1.0bar



WALL SPOUTS
 Opt for a stylish wall-mounted spout to suit your space and style. See page 271.

Concealed shower solutions

RECITE SHOWERS



PVD
PVD hardwearing
& scratch resistant
coating. Brushed
finishes only



ECO¹
Compatible with
optional water &
energy saving flow
regulators



GUARANTEE
including
thermostatic
cartridge



RECITE VALVE HANDLE



PVD hardwearing &
scratch resistant
coating. Brushed
brass
finish only



AVAILABLE IN
CHROME
BLACK
OR
BRASS



Recite dual function shower system with riser kit & overhead shower

| | | |
|----------|---------------|----------------|
| SVSET153 | Chrome | £575.00 |
| SVSET165 | Black | £675.00 |
| SVSET174 | Brushed brass | £985.00 |

Separate flow and temperature controls
 250mm stainless steel overhead shower
 110mm 3 function push button control shower handset
 Anti-Scald thermostatic control for safe showering
 770mm long riser rail
 Includes easy fix brass shower arm and elbow
 Minimum pressure 0.5bar

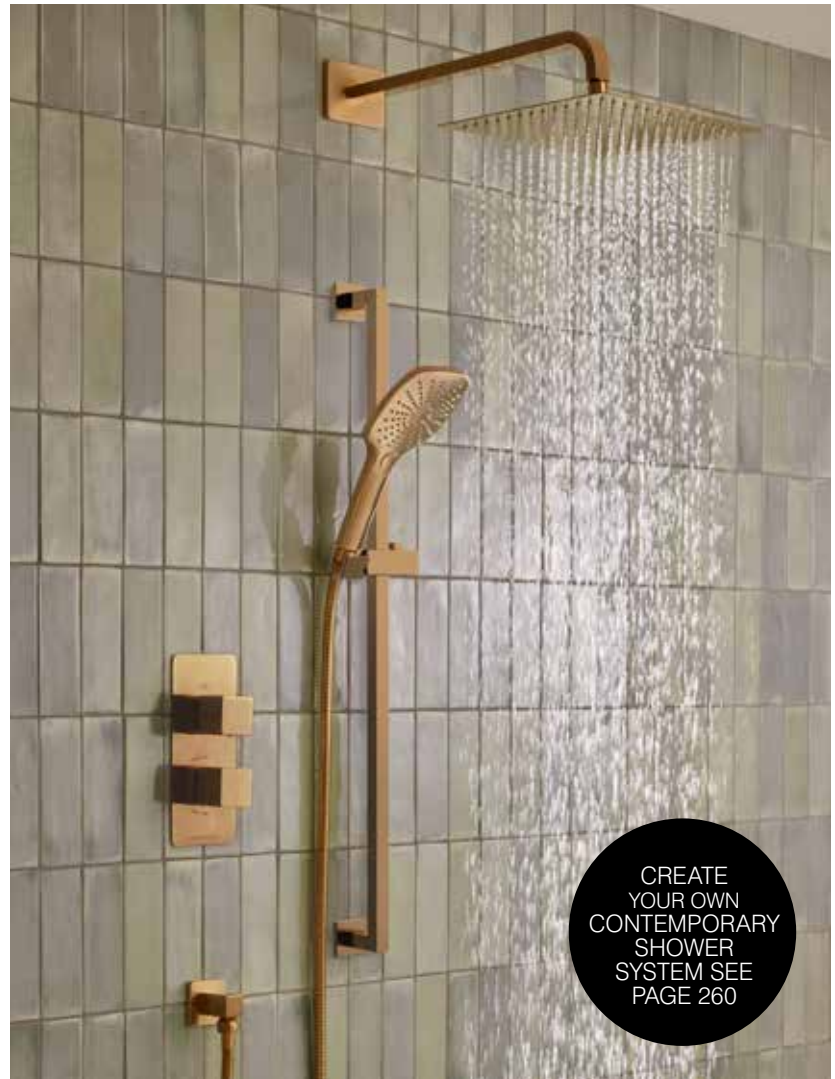

CREATE YOUR OWN CONTEMPORARY SHOWER SYSTEM SEE PAGE 260



Recite single function valve

| | | |
|----------|---------------|----------------|
| SV4004 | Chrome | £284.00 |
| SV400403 | Black | £412.00 |
| SV400404 | Brushed brass | £635.00 |

90(w) x 215mm(h)
 Minimum pressure 0.5bar



Recite dual function valve

| | | |
|--------|---------------|----------------|
| SV4006 | Chrome | £319.00 |
| SV4015 | Black | £445.00 |
| SV4019 | Brushed brass | £675.00 |

90(w) x 215mm(h)
 Minimum pressure 0.5bar



Recite triple function valve

| | | |
|----------|---------------|----------------|
| SV4009 | Chrome | £535.00 |
| SV400903 | Black | £665.00 |
| SV400904 | Brushed brass | £880.00 |

90(w) x 295mm(h)
 Minimum pressure 1.0bar

EVENT SHOWERS



ECO¹
Compatible with optional
water & energy saving
flow regulators



GUARANTEE
including
thermostatic
cartridge



Event single function shower system with riser kit

SVSET20 Chrome **£605.00**

Separate flow and temperature controls
100mm single function shower handset
Anti-Scald thermostatic control for safe showering
Adjustable riser rail brackets to suit existing wall fixings
Minimum pressure 0.1bar



Event dual function shower system with riser kit & overhead shower

SVSET01 Chrome **£755.00**

Separate flow and temperature controls
220mm overhead shower
100mm single function shower handset
Anti-Scald thermostatic control for safe showering
Adjustable riser rail brackets to suit existing wall fixings
Includes easy fix shower arm and elbow
Minimum pressure 0.5bar



Event dual function shower system with riser kit, overhead shower

SVSET42 Chrome **£895.00**

Separate flow and temperature controls
250mm stainless steel overhead shower
100mm single function shower handset
Anti-Scald thermostatic control for safe showering
Adjustable riser rail brackets to suit existing wall fixings
Includes easy fix shower arm and elbow
Minimum pressure 0.5bar

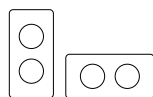

plates can be mounted horizontally or vertically

Event valve

SV1404 Single function **£417.00**
SV1406 Dual function **£456.00**

102(w) x 214mm(h)
Single function minimum pressure 0.1bar
Dual function minimum pressure 0.3bar

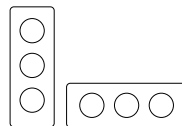

plates can be mounted horizontally or vertically

Event valve

SV1409 Triple function **£695.00**

102(w) x 280mm(h)
Minimum pressure 1.0bar



EVENT ROUND VALVE HANDLE

Concealed shower solutions

CLEAR SHOWERS



ECO¹
Compatible with optional
water & energy saving
flow regulators



AIR-DRIVE
Uses less water
without compromising
your shower experience



GUARANTEE
including
thermostatic
cartridge



**Clear dual function shower system
with riser kit & overhead shower**

SVSET141 Chrome **£895.00**

Separate flow and temperature controls
250mm stainless steel overhead shower
110mm Air-drive 5 function shower handset
Anti-Scald thermostatic control for safe showering
655mm long riser rail
Includes easy fix brass shower arm and elbow
Minimum pressure 0.5bar



**Clear triple function shower system
with riser kit, overhead shower
& smartflow bath filler**

SVSET142 Chrome **£1,220.00**

Separate flow and temperature controls
250mm stainless steel overhead shower
110mm Air-drive 5 function shower handset
Anti-Scald thermostatic control for safe showering
655mm long riser rail
Includes easy fix brass shower arm and elbow
Smartflow bath overflow filler
Minimum pressure 1.0bar

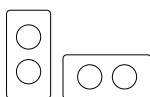

plates can be mounted
horizontally or vertically

Clear valve

SV3713 Single function **£417.00**
SV3706 Dual function **£456.00**

102(w) x 214mm(h)
Single function minimum pressure 0.1bar
Dual function minimum pressure 0.3bar

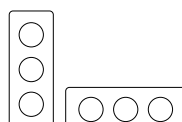

plates can be mounted
horizontally or vertically

Clear valve

SV3709 Triple function **£695.00**

102(w) x 280mm(h)
Minimum pressure 1.0bar



CLEAR VALVE HANDLE

Making things simple

BAR SHOWER SYSTEMS

Our bar shower systems allow for quick and easy installation with minimal disruption to the bathroom as they do not need to be recessed into a wall. Our selection of modern bar shower systems offer form and function, all in one easy to fit and control unit. Available in smooth, round or sleek square designs.



GUARANTEE
including
thermostatic
cartridge





Shower solutions

WALCOT BAR SHOWERS



PVD
PVD hardwearing
& scratch resistant
coating. Brushed
finishes only



ECO¹
Compatible with optional
water & energy saving
flow regulators



GUARANTEE
including
thermostatic
cartridge





Walcot Dual Function Bar Shower System

| | | |
|----------|----------------|---------|
| SVSET230 | Brushed brass | £695.00 |
| SVSET233 | Brushed nickel | £695.00 |

Cool Touch technology ensuring the valve is not hot to the touch during use
250mm overhead shower
Single function shower handset
Made from high quality brass materials
Anti-Scald thermostatic control for safe showering
Height adjustable riser rail
Includes bar valve compression quick fixing kit
1.5m easy clean smooth shower hose
Minimum pressure 1.0bar



Shower solutions

FABER BAR SHOWERS



PVD
PVD hardwearing
& scratch resistant
coating. Brushed
finishes only



ECO¹
Compatible with optional
water & energy saving
flow regulators



GUARANTEE
including
thermostatic
cartridge



AVAILABLE IN
BRUSHED
NICKEL,
BRUSHED
BRONZE OR
CHROME





Faber Dual Function Bar Shower System

| | | |
|----------|----------------|---------|
| SVSET226 | Chrome | £525.00 |
| SVSET227 | Brushed nickel | £695.00 |
| SVSET228 | Brushed bronze | £695.00 |

Cool Touch technology ensuring the valve is not hot to the touch during use
250mm overhead shower
Single function shower handset
Made from high quality brass materials
Anti-Scald thermostatic control for safe showering
Height adjustable riser rail
Includes bar valve compression quick fixing kit
1.5m easy clean smooth shower hose
Minimum pressure 1.0bar



Shower solutions

UNITY BAR SHOWERS



PVD
PVD hardwearing
& scratch resistant
coating. Brushed
finishes only



ECO¹
Compatible with optional
water & energy saving
flow regulators



GUARANTEE
including
thermostatic
cartridge





Unity Dual Function Bar Shower System

| | | |
|----------|---------------|---------|
| SVSET171 | Chrome | £449.00 |
| SVSET166 | Black | £540.00 |
| SVSET168 | Brushed brass | £650.00 |

Cool Touch technology ensuring the valve is not hot to the touch during use
250mm stainless steel overhead shower
120mm 3 function push button control
shower handset
Anti-Scald thermostatic control for safe showering
Height adjustable riser rail
Includes bar valve compression quick fixing kit
Minimum pressure 0.5bar



Shower solutions

RECITE BAR SHOWERS



PVD
PVD hardwearing
& scratch resistant
coating. Brushed
finishes only



ECO1
Compatible with optional
water & energy saving
flow regulators



GUARANTEE
including
thermostatic
cartridge





**Recite Dual Function
Bar Shower System**

| | | |
|----------|---------------|----------------|
| SVSET172 | Chrome | £449.00 |
| SVSET167 | Black | £540.00 |
| SVSET169 | Brushed brass | £650.00 |

Cool Touch technology ensuring the valve is not hot to the touch during use
250mm stainless steel overhead shower
110mm 3 function push button control
shower handset
Anti-Scald thermostatic control for safe showering
Height adjustable riser rail
Includes bar valve compression quick fixing kit
Minimum pressure 0.5bar



Shower solutions

EVENT BAR SHOWERS



ECO¹
Compatible with optional
water & energy saving
flow regulators



GUARANTEE
including
thermostatic
cartridge



Event dual function bar shower system

SVSET30 Chrome £570.00

- Separate flow and temperature controls
- 200mm overhead shower
- 110mm Air-drive 5 function shower handset
- Anti-Scald thermostatic control for safe showering
- Height adjustable riser rail
- Includes bar valve compression quick fixing kit
- Minimum pressure 1.0bar





Shower solutions

CONCEALED & EXPOSED SHOWERS



GUARANTEE
including
thermostatic
cartridge

Concealed and exposed showers offer both functionality and style, catering to a range of design preferences. Whether you opt for the minimalist appeal of concealed fixtures or the classic charm of exposed designs, these showers are available in single, dual, and triple mixer options to suit your water control needs. Each configuration brings a sophisticated finish to your bathroom or shower room, blending seamlessly with your bathroom décor. To complete the look, explore our wide selection of bathroom taps and accessories, thoughtfully curated to ensure a cohesive aesthetic throughout your space.



COORDINATING TAPS

Pair our traditional showers with our coordinating taps to ensure a seamless design in your bathroom. See pages 198-211.





Timeless shower solutions

WALCOT SHOWERS



PVD
PVD hardwearing
& scratch resistant
coating.



ECO¹
Compatible with optional
water & energy saving
flow regulators



GUARANTEE
including
thermostatic
cartridge

ALSO
AVAILABLE IN
BRUSHED
BRASS
SEE PAGE
250



WALCOT VALVE HANDLE

For Walcot bar shower options see page 242



Walcot dual function shower system with outlet riser kit & overhead shower

SVSET237 Brushed nickel **£1,200.00**

- Separate flow and temperature controls
- 250mm overhead shower
- Single function shower handset
- Anti-Scald thermostatic control for safe showering
- Riser rail includes outlet
- Includes easy fix brass shower arm and riser outlet
- 1.5m easy clean smooth shower hose
- Min pressure 1.0bar



Walcot dual function shower system with overhead shower & handset outlet

SVSET238 Brushed nickel **£1,150.00**

- Separate flow and temperature controls
- 250mm overhead shower
- Single function shower handset
- Anti-Scald thermostatic control for safe showering
- Includes easy fix brass shower arm and elbow
- 1.5m easy clean smooth shower hose
- Min pressure 1.0bar



Walcot dual function shower system with ceiling head & handset outlet

SVSET239 Brushed nickel **£1,150.00**

- Separate flow and temperature controls
- 250mm ceiling shower
- Single function shower handset
- Anti-Scald thermostatic control for safe showering
- Includes easy fix brass elbow
- 1.5m easy clean smooth shower hose
- Min pressure 1.0bar



COMPLETE YOUR SPACE

Match our Walcot showers with Walcot taps and accessories for a harmonious and refined bathroom collection. See p198 for taps and p285 for accessories.



CREATE YOUR OWN TRADITIONAL SHOWER SYSTEM SEE PAGE 273



Walcot dual function shower valve

SV510906 Brushed nickel **£770.00**

215(h) x 100(w)mm
Dual function minimum pressure 0.5bar

Timeless shower solutions

WALCOT SHOWERS



PVD
PVD hardwearing
& scratch resistant
coating.



ECO1
Compatible with optional
water & energy saving
flow regulators



GUARANTEE
including
thermostatic
cartridge

ALSO
AVAILABLE IN
BRUSHED
NICKEL
SEE PAGE
248



WALCOT VALVE HANDLE

For Walcot bar shower options see page 236



Walcot dual function shower system with outlet riser kit & overhead shower

SVSET218 Brushed brass **£1,200.00**

- Separate flow and temperature controls
- 250mm overhead shower
- Single function shower handset
- Anti-Scald thermostatic control for safe showering
- Riser rail includes outlet
- Includes easy fix brass shower arm and riser outlet
- 1.5m easy clean smooth shower hose
- Min pressure 1.0bar



Walcot dual function shower system with overhead shower & handset outlet

SVSET221 Brushed brass **£1,150.00**

- Separate flow and temperature controls
- 250mm overhead shower
- Single function shower handset
- Anti-Scald thermostatic control for safe showering
- Includes easy fix brass shower arm and elbow
- 1.5m easy clean smooth shower hose
- Min pressure 1.0bar



Walcot dual function shower system with ceiling head & handset outlet

SVSET224 Brushed brass **£1,150.00**

- Separate flow and temperature controls
- 250mm ceiling shower
- Single function shower handset
- Anti-Scald thermostatic control for safe showering
- Includes easy fix brass elbow
- 1.5m easy clean smooth shower hose
- Min pressure 1.0bar



COMPLETE YOUR SPACE

Match our Walcot showers with Walcot taps and accessories for a harmonious and refined bathroom collection. See p194 for taps and p279 for accessories.



CREATE YOUR OWN TRADITIONAL SHOWER SYSTEM SEE PAGE 273



Walcot dual function shower valve

SV510904 Brushed brass **£770.00**

- 215(h) x 100(w)mm
- Dual function minimum pressure 0.5bar

Timeless shower solutions

KESWICK SHOWERS



PVD
PVD hardwearing
& scratch resistant
coating. Brushed
brass finish



ECO¹
Compatible with
optional water &
energy saving flow
regulators



GUARANTEE
including
thermostatic
cartridge



ALSO
AVAILABLE IN
CHROME
SEE PAGE
254

Keswick dual function shower system with overhead shower & handset

Separate flow and temperature controls
200mm overhead shower
70mm single function shower handset
Anti-Scald thermostatic control for safe showering
Riser rail and shower arm can be cut to length to suit installation
Includes 15mm compression fixing kit
Min pressure 0.5bar

SVSET175 Timeless brushed brass **£1,300.00**



Keswick dual function shower system with riser kit & overhead shower

Separate flow and temperature controls
200mm overhead shower
70mm single function shower handset
Anti-Scald thermostatic control for safe showering
Riser rail and shower arm can be cut to length to suit installation
Includes easy fix brass shower arm and elbow
Min pressure 0.5bar

SVSET178 Timeless brushed brass **£1,240.00**



Keswick dual function shower system with handset, holder & overhead shower

Separate flow and temperature controls
200mm overhead shower
70mm single function shower handset
Anti-Scald thermostatic control for safe showering
Includes easy fix brass shower arm and elbow
Min pressure 0.5bar

SVSET179 Timeless brushed brass **£1,130.00**

SURFACE MOUNTED
Timeless shower systems

CONCEALED
Timeless shower systems



CREATE
YOUR OWN
TRADITIONAL
SHOWER SYSTEM
SEE PAGE
273

Keswick valve

SV340604 Dual function **£700.00**

120(w) x 215mm(h)
Dual function minimum pressure 0.5bar



Keswick dual function shower system with handset, holder & wall spout*

Separate flow and temperature controls
70mm single function shower handset
Anti-Scald thermostatic control for safe showering
Min pressure 0.5bar

SVSET180 Timeless brushed brass £855.00

*Wall spout also available separately. See page 277



COMPLETE YOUR SPACE

Match our Keswick showers with Keswick taps and accessories for a harmonious and refined bathroom collection. See p196 for taps and p282 for accessories.

PAIR WITH
KESWICK
TAPS
P196



KESWICK VALVE HANDLE

PAIR WITH
KESWICK
TAPS
P198

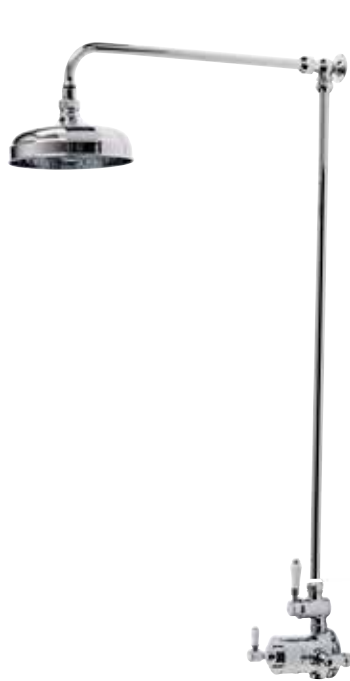

Keswick single function shower system with overhead shower

SVSET130 Chrome **£940.00**

Separate flow and temperature controls
200mm overhead shower
Anti-Scald thermostatic control for safe showering
Riser rail and shower arm can be cut to length to suit installation
Includes 15mm compression fixing kit
Min pressure 0.2bar



Keswick dual function shower system with overhead shower & handset

SVSET129 Chrome **£1,030.00**

Separate flow and temperature controls
200mm overhead shower
70mm single function shower handset
Anti-Scald thermostatic control for safe showering
Riser rail and shower arm can be cut to length to suit installation
Includes 15mm compression fixing kit
Min pressure 0.5bar



Keswick single function shower system with overhead shower

SVSET132 Chrome **£745.00**

Separate flow and temperature controls
200mm overhead shower
70mm single function shower handset
Anti-Scald thermostatic control for safe showering
Min pressure 0.2bar

SURFACE MOUNTED
Timeless shower systems



KESWICK VALVE HANDLE



Timeless shower solutions

KESWICK SHOWERS

ALSO AVAILABLE IN
TIMELSS
BRUSHED
BRASS
SEE PAGE 252



ECO¹
Compatible with optional
water & energy saving
flow regulators



GUARANTEE
including
thermostatic
cartridge



Keswick dual function shower system with handset, holder & wall spout*

SVSET182 Chrome £745.00

Separate flow and temperature controls
70mm single function shower handset
Anti-Scald thermostatic control for
safe showering
Includes easy fix brass shower arm
and elbow
Min pressure 0.5bar

*Wall spout also available
separately. See page 277

Keswick dual function shower system with handset, holder & overhead shower

SVSET181 Chrome £885.00

Separate flow and temperature controls
200mm overhead shower
70mm single function shower handset
Anti-Scald thermostatic control for
safe showering
Includes easy fix brass shower arm
and elbow
Min pressure 0.5bar

Keswick dual function shower system with riser kit & overhead shower

SVSET131 Chrome £940.00

Separate flow and temperature controls
200mm overhead shower
70mm single function shower handset
Anti-Scald thermostatic control for
safe showering
620mm long riser rail
Includes easy fix brass shower arm
and elbow
Min pressure 0.5bar

Keswick triple function shower system with riser kit, overhead shower & smartflow bath filler

SVSET133 Chrome £1,220.00

Separate flow and temperature controls
200mm overhead shower
70mm single function shower handset
Anti-Scald thermostatic control for
safe showering
620mm long riser rail
Includes easy fix brass shower arm
and elbow
Traditional Smartflow bath overflow filler
Min pressure 1.0bar

CONCEALED Timeless shower systems



CREATE
YOUR OWN
TRADITIONAL
SHOWER SYSTEM
SEE PAGE
273

COMPLETE YOUR SPACE

Match our Keswick showers with Keswick taps and accessories for a harmonious and refined bathroom collection. See p198 for taps and p282 for accessories.

Keswick valve

SV3406 Dual function £510.00

120(w) x 215mm(h)
Dual function minimum pressure 0.5bar

PAIR WITH
CRANBORNE
TAPS
P202

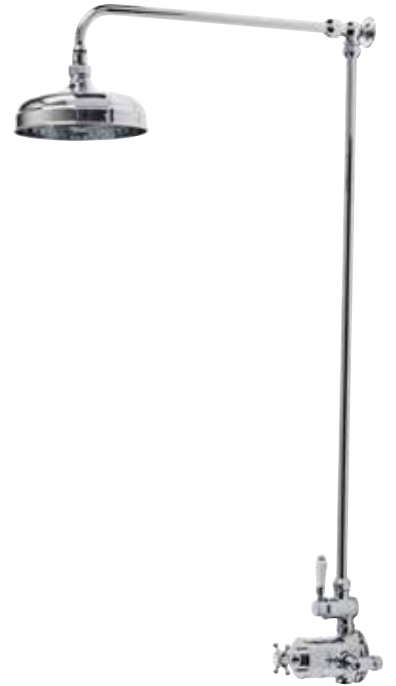

**Cranborne single function
shower system with
overhead shower**

SVSET125 Chrome £940.00

Separate flow and temperature controls
200mm overhead shower
Anti-Scald thermostatic control for
safe showering
Riser rail and shower arm can be cut
to length to suit installation
Includes 15mm compression fixing kit
Min pressure 0.2bar

SURFACE MOUNTED
Shower systems



CRANBORNE VALVE HANDLE

Timeless shower solutions

CRANBORNE SHOWERS



ECO¹
Compatible with optional
water & energy saving
flow regulators



GUARANTEE
including
thermostatic
cartridge



Cranborne dual function shower system with overhead shower & handset

SVSET124 Chrome **£1,030.00**

Separate flow and temperature controls
200mm overhead shower
70mm single function shower handset
Anti-Scald thermostatic control for safe showering
Riser rail and shower arm can be cut to length to suit installation
Includes 15mm compression fixing kit
Min pressure 0.5bar



Cranborne single function shower system with overhead shower

SVSET127 Chrome **£745.00**

Separate flow and temperature controls
200mm overhead shower
70mm single function shower handset
Anti-Scald thermostatic control for safe showering
Min pressure 0.2bar



Cranborne dual function shower system with riser kit & overhead shower

SVSET126 Chrome **£940.00**

Separate flow and temperature controls
200mm overhead shower
70mm single function shower handset
Anti-Scald thermostatic control for safe showering
620mm long riser rail
Includes easy fix brass shower arm and elbow
Min pressure 0.5bar



Cranborne triple function shower system with riser kit, overhead shower & smartflow bath filler

SVSET128 Chrome **£1,220.00**

Separate flow and temperature controls
200mm overhead shower
70mm single function shower handset
Anti-Scald thermostatic control for safe showering
620mm long riser rail
Includes easy fix brass shower arm and elbow
Traditional Smartflow bath overflow filler
Min pressure 1.0bar

SURFACE MOUNTED
Shower systems

CONCEALED
Shower systems

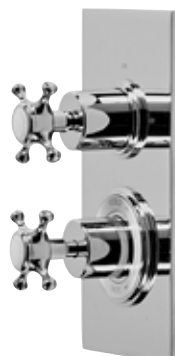
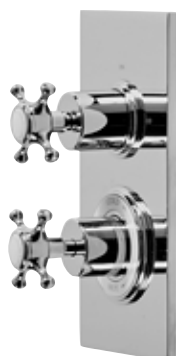

PAIR WITH
HENLEY
TAPS
P204

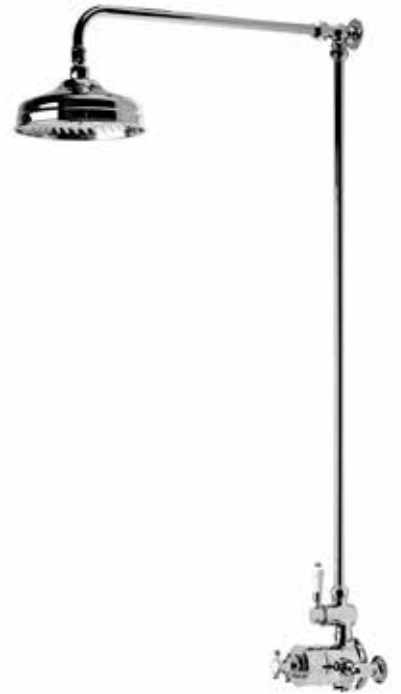

**Henley single function
shower system with
overhead shower**

SVSET51 Chrome £940.00

Separate flow and temperature controls
200mm overhead shower
Anti-Scald thermostatic control for
safe showering
Riser rail and shower arm can be cut
to length to suit installation
Includes 15mm compression fixing kit
Min pressure 0.2bar

SURFACE MOUNTED
Shower systems



HENLEY VALVE HANDLE



Timeless shower solutions

HENLEY SHOWERS



ECO¹
Compatible with optional
water & energy saving
flow regulators



GUARANTEE
including
thermostatic
cartridge



Henley dual function shower system with overhead shower & handset

SVSET50 Chrome **£1,030.00**

Separate flow and temperature controls
200mm overhead shower
70mm single function shower handset
Anti-Scald thermostatic control for safe showering
Riser rail and shower arm can be cut to length to suit installation
Includes 15mm compression fixing kit
Min pressure 0.5bar



Henley single function shower system with overhead shower

SVSET53 Chrome **£745.00**

Separate flow and temperature controls
200mm overhead shower
70mm single function shower handset
Anti-Scald thermostatic control for safe showering
Min pressure 0.2bar



Henley dual function shower system with riser kit & overhead shower

SVSET52 Chrome **£940.00**

Separate flow and temperature controls
200mm overhead shower
70mm single function shower handset
Anti-Scald thermostatic control for safe showering
620mm long riser rail
Includes easy fix brass shower arm and elbow
Min pressure 0.5bar



Henley triple function shower system with riser kit, overhead shower & smartflow bath filler

SVSET146 Chrome **£1,220.00**

Separate flow and temperature controls
200mm overhead shower
70mm single function shower handset
Anti-Scald thermostatic control for safe showering
620mm long riser rail
Includes easy fix brass shower arm and elbow
Traditional Smartflow bath overflow filler
Min pressure 1.0bar

SURFACE MOUNTED
Shower systems



CONCEALED
Shower systems

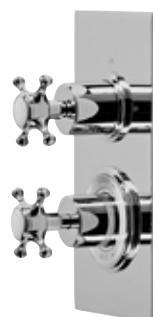
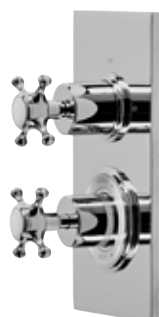



CREATE YOUR OWN SHOWER

If our shower packages don't suit your requirements then you can design your own shower to meet your own specific needs & style. The guide in this section will help you select the right thermostatic valve for the job. Then browse the following few pages to select from the different shower components available & build a shower which is bespoke to you.



Make it unique

CREATING YOUR OWN SHOWER

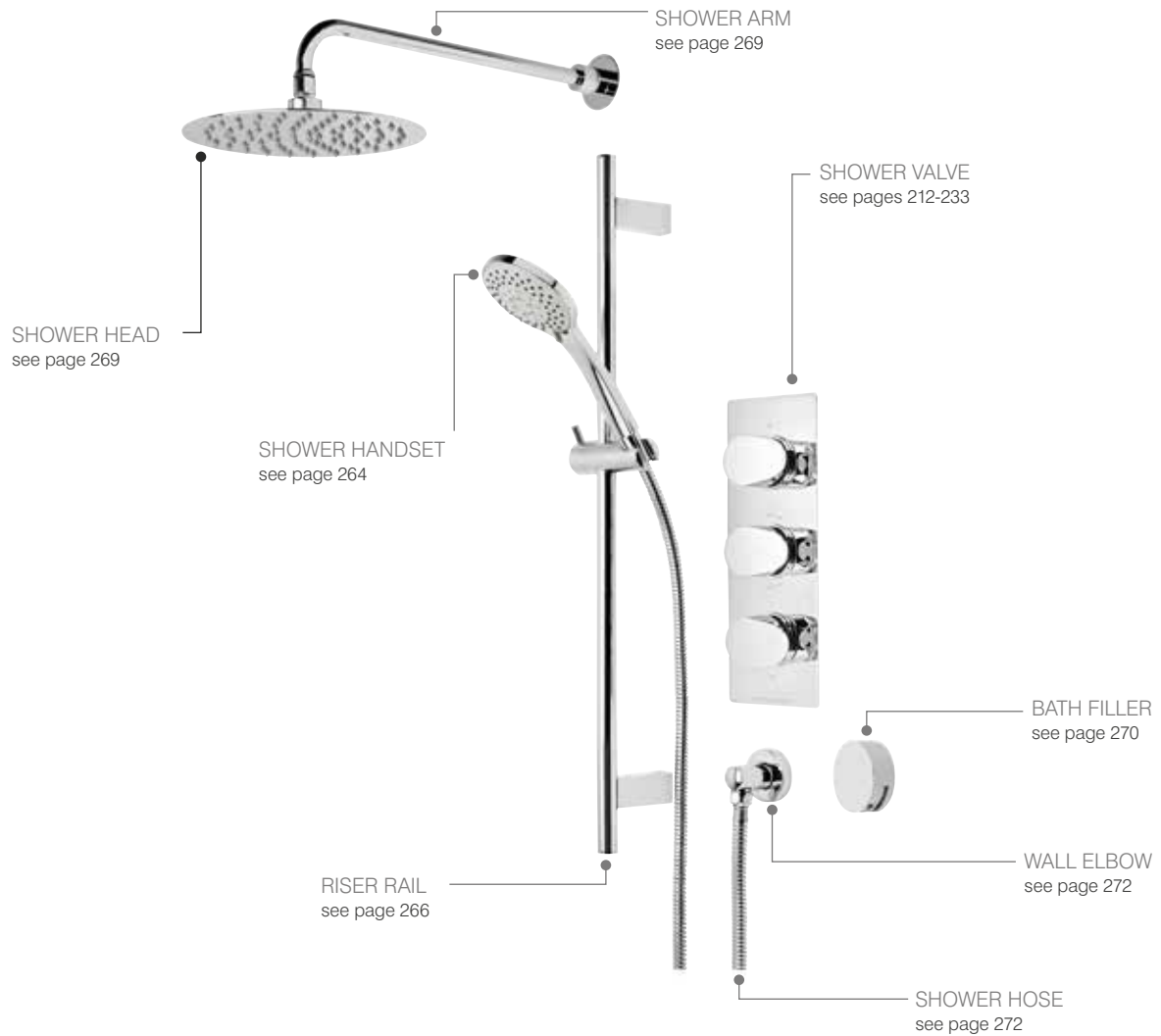

CHOOSE HOW MANY FUNCTIONS YOU REQUIRE

How many functions would you like your shower to control?
Our selection of valves give the option to choose from single, dual and triple function controls, see pages 212-233

SINGLE OUTLET

for single function valves to control a fixed head, handset or bath filler

DUAL OUTLETS

delivering water to two separate outlets for dual function valves to control two outlets, see options opposite

TRIPLE OUTLETS

delivering water to three separate outlets for triple function valves to control three outlets, see options opposite





SHOWER HANDSET



OVERHEAD SHOWER



SMARTFLOW
BATH FILLER



BATH MOUNTED
SHOWER KIT

OUTLET OPTIONS FOR SHOWER VALVES

Once you have decided whether you want a single, dual or triple function shower valve (p212-233), next you need to decide what outlets you would like your system to control. Choose from the selection above, all of which are available from Roper Rhodes, see pages 264-273 for all available options.

Make it unique

SHOWER HANDSETS



PVD
PVD hardwearing
& scratch resistant
coating. Brushed
finishes only



AIR-DRIVE
Uses less water
without compromising
your shower experience



**Event-Click triple function
push button control handset**
120mm(dia)mm
Min pressure 1.0bar

SVHEAD38 Chrome **£46.20**



**Air-Drive
round five function handset**
110mm(dia)mm
Min pressure 0.5bar

SVHEAD29 Chrome **£38.30**



Round five function handset
100mm(dia)mm
Min pressure 0.5bar

SVHEAD23 Chrome **£37.40**



Round single function handset
100mm(dia)mm
Min pressure 0.2bar

SVHEAD24 Chrome **£25.40**



**Air-Drive
square single function handset**
80 x 95mm head
Min pressure 1.0bar

SVHEAD28 Chrome **£38.30**



Walcot shower handset
80mm (dia)
Min pressure 0.5bar

SVHEAD98 Brushed brass **£80.00**

SVHEAD103 Brushed nickel **£80.00**



Unity triple function handset
120 x 120mm head
Min pressure 0.5bar

SVHEAD43 Chrome **£38.60**

SVHEAD44 Black **£45.10**

SVHEAD53 Brushed brass **£62.40**



Recite triple function handset
120 x 110mm head
Min pressure 0.5bar

SVHEAD45 Chrome **£38.60**

SVHEAD51 Black **£45.50**

SVHEAD55 Brushed brass **£62.40**



PRE-SELECTED

Unsure which shower head to pair with which riser rail? To make your decision a little easier we have also pre-selected a number of shower handsets and rails into shower kits see p266 for details

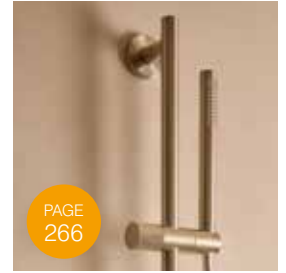

PAGE
266

All microphone handsets have a min pressure 0.2bar
Constructed from brass materials

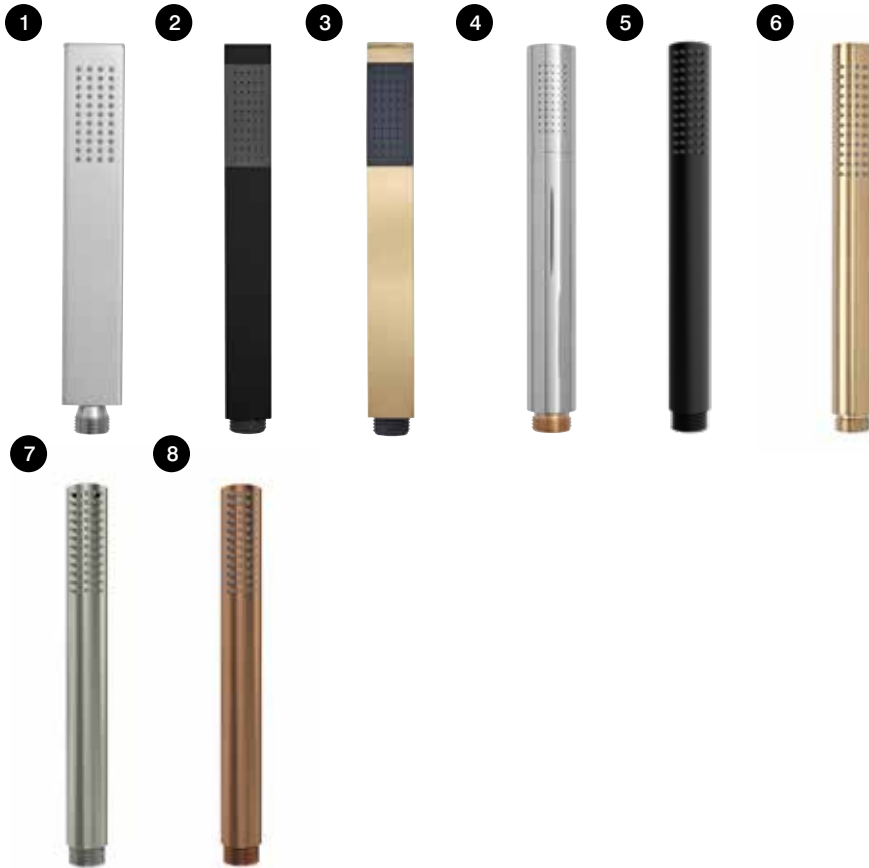

1. **Square microphone handset**
25(w) x 220(h)mm
SVHEAD40 Chrome **£38.60**
2. **Square microphone handset**
25(w) x 220(h)mm
SVHEAD42 Black **£45.10**
3. **Square microphone handset**
25(w) x 220(h)mm
SVHEAD60 Brushed brass **£51.10**
4. **Round microphone handset**
24(w) x 220(h)mm
SVHEAD39 Chrome **£38.60**
5. **Round microphone handset**
25(w) x 220(h)mm
SVHEAD41 Black **£45.10**
6. **Round microphone handset**
25(w) x 220(h)mm
SVHEAD47 Brushed brass **£51.10**
7. **Round microphone handset**
25(w) x 220(h)mm
SVHEAD89 Brushed nickel **£51.10**
8. **Round microphone handset**
25(w) x 220(h)mm
SVHEAD91 Brushed bronze **£51.10**

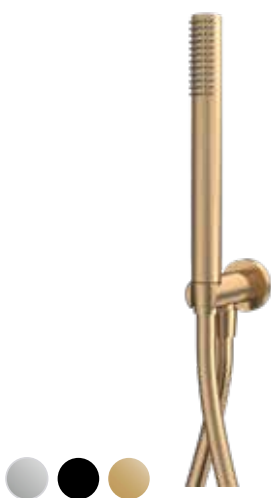

- Round microphone handset with elbow outlet & hose**
Min pressure 0.2bar
- | | | |
|---------|---------------|----------------|
| SVACS19 | Chrome | £103.00 |
| SVACS41 | Black | £111.50 |
| SVACS42 | Brushed brass | £137.50 |



- Event-click handset with elbow outlet & hose**
Min pressure 1.0bar
- | | | |
|---------|--------|----------------|
| SVACS21 | Chrome | £116.00 |
|---------|--------|----------------|



- Square microphone handset with elbow outlet & hose**
Min pressure 0.2bar
- | | | |
|---------|--------|----------------|
| SVACS20 | Chrome | £123.00 |
|---------|--------|----------------|



- Faber microphone handset with elbow outlet & hose**
Minimum pressure 1.0bar
- | | | |
|---------|----------------|----------------|
| SVACS54 | Chrome | £150.00 |
| SVACS55 | Brushed nickel | £175.00 |
| SVACS56 | Brushed bronze | £175.00 |

Make it unique

RISER RAILS

1



2



3



4



1. **Wave riser rail with adjustable wall bracket positions**
685(h)mm adjustable

SVRAIL01 Chrome **£81.00**

2. **Event-click riser rail**
865(h)mm

SVRAIL07 Chrome **£108.00**

3. **Event-click adjustable riser rail**
760(h)mm

SVRAIL08 Chrome **£110.00**

4. **Sanctuary riser rail**
760(h)mm

SVRAIL02 Chrome **£159.50**



Unity riser rail with adjustable wall bracket positions
700(h)mm

| | | |
|----------|---------------|----------------|
| SVRAIL09 | Chrome | £90.10 |
| SVRAIL10 | Black | £96.50 |
| SVRAIL14 | Brushed brass | £130.50 |



Recite riser rail
770(h)mm

| | | |
|----------|--------|---------------|
| SVRAIL11 | Chrome | £90.10 |
| SVRAIL13 | Black | £96.30 |



Unity shower kit
Includes riser rail (adjustable wall bracket position), shower hose and round shower handset
Minimum pressure 1.0bar

| | | |
|---------|---------------|----------------|
| SVKIT21 | Chrome | £155.00 |
| SVKIT22 | Black | £168.00 |
| SVKIT26 | Brushed brass | £187.50 |

Make it unique

SHOWER KITS



PVD
PVD hardwearing & scratch resistant coating. Brushed finishes only



AIR-DRIVE
Uses less water without compromising your shower experience



ECO¹
All shower kits are compatible with optional water & energy saving flow regulators



Crest chrome shower kit
Includes Wave riser rail (adjustable wall bracket position), shower hose and round single function handset
Ideal for low pressure
Min pressure 0.2bar

SVKIT05 **£130.50**



Event-click chrome shower kit
Includes Event-Click brass riser rail, easy clean smooth shower hose and three function push button control handset
Min pressure 1.0bar

SVKIT20 **£168.00**



Dive chrome shower kit
Includes Dive round riser rail, easy clean smooth shower hose with metallic effect hose, Air-drive five function shower handset
Min pressure 0.5bar

SVKIT11 **£171.00**



Event-click chrome shower kit
Includes Event-Click brass riser rail, Easy clean smooth shower hose and three function push button control handset
Min pressure 1.0bar

SVKIT14 **£178.00**



Spa chrome shower kit
Includes Sanctuary brass riser rail, shower hose and round five function shower handset
Min pressure 0.5bar

SVKIT03 **£209.00**



Recite shower kit
Includes square riser rail, shower hose and square shower handset
Minimum pressure 1.0bar

SVKIT23 Chrome **£155.00**
SVKIT24 Black **£170.00**



Recite shower kit
Includes square riser rail, shower hose and square shower handset
Minimum pressure 1.0bar

SVKIT25 Brushed brass **£155.00**



Faber shower kit
Includes riser rail, shower hose and microphone shower handset
Minimum pressure 1.0bar

SVKIT38 Chrome **£190.00**
SVKIT40 Brushed nickel **£230.00**
SVKIT41 Brushed bronze **£230.00**



Walcot shower kit
Includes riser rail, shower hose and shower handset
Minimum pressure 1.0bar

SVKIT43 Brushed brass **£250.00**
SVKIT44 Brushed nickel **£250.00**

Make it unique

OVERHEAD SHOWERS



Square 300mm ceiling flush mounted stainless steel overhead shower
300(w) x 300mm(d)
Minimum pressure 1.0bar

SVHEAD33 **£363.00**

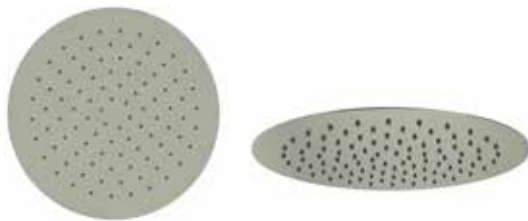

Round 300mm ceiling flush mounted stainless steel overhead shower
300mm(dia)
Minimum pressure 1.0bar

| | | |
|----------|----------------|----------------|
| SVHEAD34 | Chrome | £326.00 |
| SVHEAD93 | Brushed bronze | £350.00 |
| SVHEAD92 | Brushed nickel | £350.00 |



Use an 80mm arm for a sleek, flush ceiling-mounted look, or choose a 340mm arm to bring the shower head closer for a more immersive experience.



Ceiling arms
Constructed from brass material

| | | |
|-----------------|---------------|---------------|
| 80mm(h) | | |
| SVARM06 | Chrome | £32.80 |
| SVARM20 | Black | £42.80 |
| SVARM21 | Brushed brass | £53.50 |
| 340mm(h) | | |
| SVARM04 | Chrome | £76.90 |



PVD
PVD hardwearing
& scratch resistant
coating. Brushed
finishes only

Make it unique

SHOWER HEADS & ARMS

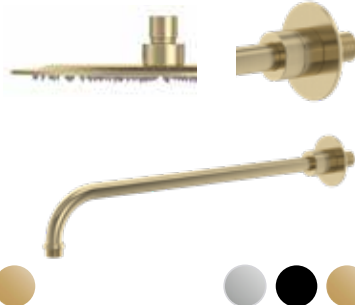

Round overhead shower made from stainless steel

250mm(dia)

Minimum pressure 0.5bar

| | | |
|----------|---------------|---------|
| SVHEAD12 | Chrome | £212.50 |
| SVHEAD46 | Black | £219.00 |
| SVHEAD52 | Brushed brass | £244.00 |

Round adjustable shower arm

Constructed from brass material
75(h) x 390mm(d)

| | | |
|---------|---------------|--------|
| SVARM01 | Chrome | £64.50 |
| SVARM12 | Black | £77.10 |
| SVARM16 | Brushed brass | £90.70 |

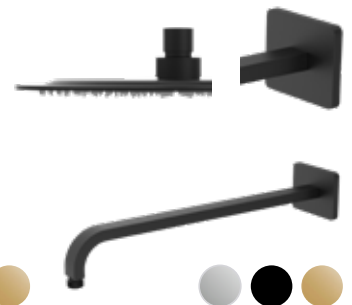

Square overhead shower made from stainless steel

250(w) x 250mm(d)

Minimum pressure 0.5bar

| | | |
|----------|---------------|---------|
| SVHEAD15 | Chrome | £247.00 |
| SVHEAD50 | Black | £249.50 |
| SVHEAD54 | Brushed brass | £274.00 |

Square shower arm

Constructed from brass material
55(h) x 415mm(d)

| | | |
|---------|---------------|---------|
| SVARM05 | Chrome | £94.60 |
| SVARM14 | Black | £102.00 |
| SVARM15 | Brushed brass | £108.50 |

200mm(dia)

Minimum pressure 0.5bar

| | | |
|----------|--------|---------|
| SVHEAD11 | Chrome | £170.00 |
|----------|--------|---------|

200(w) x 200mm(d)

Minimum pressure 0.5bar

| | | |
|----------|--------|---------|
| SVHEAD14 | Chrome | £198.50 |
|----------|--------|---------|



Event-click overhead shower

230mm(dia)

Minimum pressure 0.5bar

| | | |
|----------|--|--------|
| SVHEAD35 | | £76.60 |
|----------|--|--------|

Event-click shower arm

Constructed from brass material
70(h) x 390mm(d)

| | | |
|---------|--|--------|
| SVARM11 | | £77.10 |
|---------|--|--------|

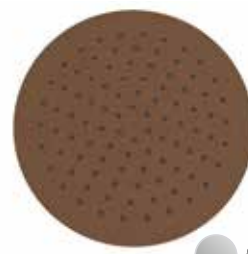

Faber overhead shower

Constructed from brass material

250mm(dia)

Minimum pressure 0.5bar

| | | |
|----------|----------------|---------|
| SVHEAD86 | Chrome | £225.00 |
| SVHEAD87 | Brushed nickel | £250.00 |
| SVHEAD88 | Brushed bronze | £250.00 |

Faber shower arm

Constructed from brass material

74(h) x 414mm(d)

| | | |
|---------|----------------|---------|
| SVARM24 | Chrome | £70.00 |
| SVARM25 | Brushed nickel | £100.00 |
| SVARM26 | Brushed bronze | £100.00 |



Walcot overhead shower

Constructed from brass material

250mm(dia)

Minimum pressure 0.5bar

| | | |
|-----------|----------------|---------|
| SVHEAD95 | Brushed brass | £255.00 |
| SVHEAD102 | Brushed nickel | £255.00 |

Walcot shower arm

Constructed from brass material

114(h) x 466(d)mm

| | | |
|---------|----------------|---------|
| SVARM28 | Brushed brass | £100.00 |
| SVARM34 | Brushed nickel | £100.00 |

The finishing touch

BATH FILLERS

With a Smartflow bath filler, water runs into your bath through the filler rather than a traditional bath mixer tap. Mounted on the inside of the bath, the Smartflow acts as a combined filler and overflow and comes with a click waste. It can be used with a manual mixer valve as a simple bath filler, or connect it to a diverter valve to control both bath and shower outlets.



PVD
PVD hardwearing & scratch resistant coating. Brushed finishes only



GUARANTEE
Smartflow bath fillers benefit from a 10 year guarantee



Traditional Smartflow bath filler
Chrome finish

SVACS12 £188.50



Smartflow bath filler (square)

| | | |
|---------|---------------|---------|
| SVACS07 | Chrome | £188.50 |
| SVACS39 | Black | £213.00 |
| SVACS40 | Brushed brass | £227.00 |



Smartflow bath filler (round)

| | | |
|---------|----------------|---------|
| SVACS02 | Chrome | £188.50 |
| SVACS23 | Black | £213.00 |
| SVACS30 | Brushed brass | £227.00 |
| SVACS49 | Brushed bronze | £227.00 |
| SVACS48 | Brushed nickel | £227.00 |



The finishing touch

BATH MOUNTED HANDSETS & SPOUTS

Choose a sleek bath-mounted handset that sits neatly on the corner of your bath, or opt for a stylish bath or wall-mounted spout to suit your space and style.



Round bath mounted shower kit

| | | |
|---------|---------------|---------|
| T221505 | Chrome | £151.00 |
| T221503 | Black | £161.00 |
| T221504 | Brushed brass | £192.50 |



Square bath mounted shower kit
Chrome finish

| | |
|---------|---------|
| T131502 | £151.00 |
|---------|---------|



Bath filling wall spout
Chrome finish

| | |
|---------|---------|
| T171402 | £156.00 |
|---------|---------|



Traditional Keswick wall mounted spout

| | | |
|---------|------------------------|---------|
| T151402 | Chrome | £90.00 |
| T151404 | Timeless brushed brass | £110.00 |

A timeless brushed brass finish, crafted in a slightly darker brass shade for a richer, refined look.



Walcot wall mounted spout

| | | |
|---------|----------------|---------|
| T511406 | Brushed nickel | £110.00 |
| T511404 | Brushed brass | £110.00 |



Modern wall mounted spout

| | | |
|---------|----------------|---------|
| T501402 | Chrome | £90.00 |
| T501403 | Black | £110.00 |
| T501404 | Brushed brass | £110.00 |
| T501408 | Brushed bronze | £110.00 |
| T501406 | Brushed nickel | £110.00 |



PVD
PVD hardwearing
& scratch resistant
coating. Brushed
finishes only

The finishing touch

SHOWER ACCESSORIES



Round wall elbow
55(w) x 55(h) x 46mm(d)

| | | |
|---------|---------------|--------|
| SVACS03 | Chrome | £46.20 |
| SVACS18 | Black | £51.50 |
| SVACS27 | Brushed brass | £62.40 |



Square wall elbow
50(w) x 50(h) x 50mm(d)

| | | |
|---------|---------------|--------|
| SVACS06 | Chrome | £46.20 |
| SVACS26 | Black | £51.10 |
| SVACS28 | Brushed brass | £62.40 |



Event-click wall elbow
70(w) x 70(h) x 64mm(d)

| | | |
|---------|--------|--------|
| SVACS16 | Chrome | £45.10 |
|---------|--------|--------|



Round wall elbow & shower handset holder
43(w) x 43(h) x 54mm(d)

| | | |
|---------|---------------|---------|
| SVACS11 | Chrome | £61.30 |
| SVACS25 | Black | £68.00 |
| SVACS31 | Brushed brass | £124.50 |



Event-click wall elbow & shower handset holder
70(w) x 70(h) x 78mm(d)

| | | |
|---------|--------|--------|
| SVACS17 | Chrome | £57.80 |
|---------|--------|--------|



Square wall elbow & shower handset holder
50(w) x 50(h) x 62mm(d)

| | | |
|---------|--------|--------|
| SVACS08 | Chrome | £61.30 |
|---------|--------|--------|



Bar valve quick fixing kit
Durable chrome plated
brass construction

| | |
|---------|--------|
| SVACS10 | £25.60 |
|---------|--------|



Brushed brass shower handset wall bracket
Made from solid brass

| | | |
|---------|---------------|--------|
| SVACS22 | Brushed brass | £38.60 |
|---------|---------------|--------|



Shower hose 1.5m
Durable chrome plated brass
construction, can be used with
high and low pressure systems

| | | |
|----------|--------|--------|
| SVHOSE01 | Chrome | £33.50 |
|----------|--------|--------|



Shower hose 1.5m
Stainless steel hose finished in
pvd brass, can be used with high
and low pressure systems

| | | |
|----------|------------------|--------|
| SVHOSE05 | Brushed brass | £60.10 |
|----------|------------------|--------|



Shower hose 1.5m
Easy clean smooth shower hose
Available in 5 finishes
Can be used with high or low
pressure systems

| | | |
|----------|----------------|--------|
| SVHOSE02 | Silver | £54.90 |
| SVHOSE04 | Black | £57.80 |
| SVHOSE06 | Brushed brass | £59.90 |
| SVHOSE08 | Brushed nickel | £59.90 |
| SVHOSE10 | Brushed bronze | £59.90 |



PVD
PVD hardwearing
& scratch resistant
coating. Brushed
brass finish

The finishing touch

CREATE YOUR OWN TRADITIONAL SHOWER

SHOWER HANDSETS



Traditional shower handset 80mm
80mm (dia)
Min pressure 0.5bar

| | | |
|----------|---------------|--------|
| SVHEAD79 | Chrome | £48.20 |
| SVHEAD80 | Brushed brass | £64.20 |

OVERHEAD SHOWERS



Traditional shower head
200mm(dia)
Minimum pressure 0.5bar

| | | |
|----------|---------------|---------|
| SVHEAD77 | Chrome | £208.50 |
| SVHEAD78 | Brushed brass | £241.00 |



Traditional shower arm
Constructed from brass material
90(h) x 500mm(d)

| | | |
|---------|---------------|--------|
| SVARM18 | Chrome | £64.20 |
| SVARM19 | Brushed brass | £89.90 |

RISER RAILS & SHOWER KITS



Traditional riser rail
620(h)mm

| | | |
|----------|---------------|---------|
| SVRAIL23 | Chrome | £161.00 |
| SVRAIL24 | Brushed brass | £214.00 |



Traditional riser kit
Traditional kit includes traditional
riser rail, shower hose and
traditional shower handset Minimum
pressure 0.5bar

| | | |
|---------|---------------|---------|
| SVKIT35 | Chrome | £214.00 |
| SVKIT36 | Brushed brass | £305.00 |

SHOWER ACCESSORIES



**Traditional wall elbow &
shower handset outlet**
52(w) x 52(h) x 75mm(d)

| | | |
|---------|---------------|--------|
| SVACS37 | Chrome | £59.90 |
| SVACS38 | Brushed brass | £74.90 |



Traditional wall elbow
50(w) x 60(h) x 50mm(d)

| | | |
|---------|---------------|--------|
| SVACS35 | Chrome | £42.80 |
| SVACS36 | Brushed brass | £64.20 |

SHOWER SEATS



GUARANTEE
on all shower seats



Shower seat

Easy to install compact design
Folds up flat to the wall when not in use
Detachable from wall bracket
Holds up to 160kg
Fixings supplied
381(w) x 287(h) x 74mm(d)

TR7001

£59.50



Shower seat

Compact design
Ideal for shower cubicles
Folds up flat to the wall when not in use
Durable thermoset plastic design
Chrome plated trim
Easy to install
Holds up to 160kg
350(w) x 328mm(d) unfolded

8020

£123.00



Luxury shower seat

Compact design
Soft close seat
Ideal for shower cubicles
Folds up flat to the wall when not in use
Durable thermoset plastic design
Easy to install
Holds up to 200kg
365(w) x 360mm(d) unfolded

8030

£190.00





ACCESSORIES



Explore the accessory

COLLECTION

Get the best out of your bathroom with our selection of sophisticated accessories. Anti-tarnish and anti-rust metals make these accessories a clear choice to keep your bathroom looking chic for years to come.

Choose between traditional, curved or angular styles to complement your taps and shower and unify your bathroom look.

Accessory collection

FABER



GUARANTEE



PVD
PVD hardwearing
& scratch resistant
coating. Brushed
finishes only.



COMPLETE YOUR SPACE

Match our accessories with Faber shower systems and taps for a harmonious and refined bathroom aesthetic. See p222-225 & p238 for showers and p180-183 for taps.



Toilet roll holder

165(w) x 32(h) x 100mm(d)

| | | |
|---------|----------------|--------|
| FB18.02 | Chrome | £60.00 |
| FB18.08 | Brushed nickel | £85.00 |
| FB18.06 | Brushed bronze | £85.00 |



Towel ring

258(w) x 120(h) x 50mm(d)

| | | |
|---------|----------------|--------|
| FB22.02 | Chrome | £75.00 |
| FB22.06 | Brushed nickel | £90.00 |
| FB22.08 | Brushed bronze | £90.00 |



Robe hook

32(w) x 32(h) x 45mm(d)

| | | |
|---------|----------------|--------|
| FB20.02 | Chrome | £40.00 |
| FB20.06 | Brushed nickel | £65.00 |
| FB20.08 | Brushed bronze | £65.00 |

WALCOT



GUARANTEE



PVD
PVD hardwearing
& scratch resistant
coating. Brushed
finishes only.



COMPLETE YOUR SPACE

Match our accessories with Walcot shower systems and taps for a harmonious and refined bathroom aesthetic. See p236 & p248-251 for showers and p192-195 for taps.



Toilet roll holder

182(w) x 60(h) x 90mm(d)

WA18.04 Brushed brass **£95.00**

WA18.06 Brushed nickel **£95.00**



Towel ring

192(w) x 220(h) x 60mm(d)

WA22.04 Brushed brass **£110.00**

WA22.06 Brushed nickel **£110.00**



Robe hook

60(w) x 60(h) x 60mm(d)

WA20.04 Brushed brass **£80.00**

WA20.06 Brushed nickel **£80.00**

Accessory collection

CAPITAL



GUARANTEE



PVD
PVD hardwearing
& scratch resistant
coating. Brushed
brass finish



Toilet roll holder
140(w) x 110(h) x 40mm(d)

| | | |
|--------|---------------|--------|
| DC7001 | Chrome | £37.00 |
| DC7005 | Black | £45.50 |
| DC7030 | Brushed brass | £63.00 |



Toilet roll holder
140(w) x 45(h) x 65mm(d)

| | | |
|--------|---------------|--------|
| DC7042 | Chrome | £38.50 |
| DC7043 | Black | £45.00 |
| DC7044 | Brushed brass | £62.00 |



Robe hook
44(w) x 44(h) x 50mm(d)

| | | |
|--------|---------------|--------|
| DC7003 | Chrome | £28.70 |
| DC7007 | Black | £35.20 |
| DC7032 | Brushed brass | £45.80 |



Towel ring
170(w) x 180(h) x 40mm(d)

| | | |
|--------|---------------|--------|
| DC7002 | Chrome | £45.50 |
| DC7006 | Black | £51.90 |
| DC7031 | Brushed brass | £68.70 |



Soap dispenser
50(w) x 170(h) x 80mm(d)

| | | |
|---------|--------|---------|
| 5515.02 | Chrome | £106.00 |
|---------|--------|---------|



Toothbrush holder
70(w) x 120(h) x 110mm(d)

| | | |
|--------|---------------|--------|
| DC7004 | Chrome | £58.50 |
| DC7008 | Black | £64.90 |
| DC7033 | Brushed brass | £80.10 |



Grab bar
505(w) x 25(h) x 75mm(d)

| | | |
|--------|---------------|---------|
| DC7048 | Chrome | £123.50 |
| DC7049 | Black | £139.50 |
| DC7050 | Brushed brass | £161.00 |



GUARANTEE



PVD
PVD hardwearing
& scratch resistant
coating. Brushed
brass finish



RESTORE



Toilet roll holder
140(w) x 110(h) x 40mm(d)

| | | |
|--------|---------------|--------|
| DC7009 | Chrome | £39.00 |
| DC7034 | Black | £45.50 |
| DC7038 | Brushed brass | £63.00 |



Toothbrush holder
70(w) x 120(h) x 110mm(d)

| | | |
|--------|---------------|--------|
| DC7012 | Chrome | £58.50 |
| DC7037 | Black | £64.90 |
| DC7041 | Brushed brass | £80.10 |



Robe hook
44(w) x 44(h) x 50mm(d)

| | | |
|--------|---------------|--------|
| DC7011 | Chrome | £28.70 |
| DC7036 | Black | £35.20 |
| DC7040 | Brushed brass | £45.80 |



Towel ring
170(w) x 180(h) x 40mm(d)

| | | |
|--------|---------------|--------|
| DC7010 | Chrome | £45.50 |
| DC7035 | Black | £51.90 |
| DC7039 | Brushed brass | £68.70 |



Soap dispenser
60(w) x 185(h) x 100mm(d)

| | | |
|---------|--------|---------|
| 9715.02 | Chrome | £145.50 |
|---------|--------|---------|

Accessory collection

KESWICK



GUARANTEE



PVD
PVD hardwearing
& scratch resistant
coating. Brushed
brass finish



COMPLETE YOUR SPACE

Match our accessories with Keswick shower systems and taps for a harmonious and refined bathroom aesthetic. See p252-255 for showers and p196-199 for taps.



Toilet brush (ceramic)

460(w) x 110mm(dia)

13670 **£121.50**



Toilet roll holder

160(w) x 106(h) x 45mm(d)

4918.02 Chrome **£60.90**

4918.04 Timeless brushed brass **£73.80**



Toothbrush holder

180(w) x 120(h) x 125mm(d)

4916.02 Chrome **£60.90**

4916.04 Timeless brushed brass **£73.80**



Robe hook

55(w) x 125(h) x 90mm(d)

4920.02 Chrome **£51.80**

4920.04 Timeless brushed brass **£64.20**



Towel ring

167(w) x 185(h) x 45mm(d)

4922.02 Chrome **£60.90**

4922.04 Timeless brushed brass **£84.50**



Glass shelf (clear)

468(w) x 65(h) x 133mm(d)

4912.02 Chrome **£129.50**

4912.04 Timeless brushed brass **£213.00**



GUARANTEE

IGNITE



Toilet roll holder
165(w) x 50(h) x 70mm(d)
8518.02 **£56.90**



Toothbrush holder (frosted)
70(w) x 110(h) x 90mm(d)
8516.02 **£54.90**



Robe hook
50(w) x 50(h) x 40mm(d)
8520.02 **£33.90**



Towel ring
180(w) x 200(h) x 70mm(d)
8522.02 **£92.90**



Towel rail
610(w) x 50(h) x 70mm(d)
8524.02 **£104.00**

Accessory collection

HALO



GUARANTEE



PVD
PVD hardwearing
& scratch resistant
coating. Brushed
brass finish



Double corner basket
160(w) x 310(h) x 180mm(d)

| | | |
|---------|----------------|----------------|
| RB50.02 | Chrome | £267.00 |
| RB50.04 | Brushed brass | £295.00 |
| RB50.03 | Black | £285.00 |
| RB50.08 | Brushed bronze | £295.00 |
| RB50.06 | Brushed nickel | £295.00 |



Double bottle basket
245(w) x 310(h) x 130mm(d)

| | | |
|---------|--------|----------------|
| RB80.02 | Chrome | £289.00 |
|---------|--------|----------------|



Large bottle basket
490(w) x 40(h) x 125mm(d)

| | | |
|---------|--------|----------------|
| RB85.02 | Chrome | £206.50 |
|---------|--------|----------------|



Large corner basket
270(w) x 40(h) x 220mm(d)

| | | |
|---------|--------|----------------|
| RB40.02 | Chrome | £143.50 |
|---------|--------|----------------|

GLIDE



Toilet roll holder
100(w) x 140(h) x 65mm(d)
9518.02 **£78.20**



Robe hook
45(w) x 45(h) x 65mm(d)
9520.02 **£46.80**



Towel ring
160(w) x 230(h) x 65mm(d)
9522.02 **£108.50**



Towel rail
625(w) x 45(h) x 65mm(d)
9524.02 **£141.00**



HORIZON



Toilet roll holder
130(w) x 30(h) x 110mm(d)
7818.02 **£70.20**



Towel ring
200(w) x 25(h) x 115mm(d)
7822.02 **£96.90**



Robe hook
80(w) x 30(h) x 35mm(d)
7820.02 **£38.80**



Towel rail
645(w) x 30(h) x 60mm(d)
7824.02 **£148.50**





GUARANTEE

Accessory collection

MINIMA



Toilet roll holder
160(w) x 90(h) x 64mm(d)

6918.02 £51.50



Towel ring
195(w) x 135(h) x 65mm(d)

6922.02 £51.50



Towel rail
645(w) x 45(h) x 75mm(d)

6924.02 £85.70



Soap dispenser
50(w) x 170(h) x 80mm(d)

5515.02 £106.00



Robe hook
45(w) x 45(h) x 55mm(d)

6920.02 £34.60



GUARANTEE

SIGMA



Double corner basket
250(w) x 320(h) x 190mm(d)

CB50.02 **£263.00**

CASE



Bottle basket
290(w) x 56(h) x 123mm(d)
DB85.02 **£77.30**



Double bottle basket
290(w) x 290(h) x 125mm(d)
DB80.02 **£156.00**



Corner basket
206(w) x 56(h) x 206mm(d)
DB40.02 **£77.30**

Double corner basket
205(w) x 290(h) x 205mm(d)
DB50.02 **£187.00**



Shower caddy
290(w) x 966(h) x 153mm(d)
DB70.02 **£233.00**



GUARANTEE

Accessory collection

MADISON



Large corner basket
190(w) x 50(h) x 190mm(d)

WB40.02 £73.00



Double corner basket
185(w) x 360(h) x 185mm(d)

WB50.02 £194.00



Shower caddy
232(w) x 750(h) x 200mm(d)

WB70.02 £252.00

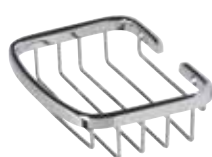

Small basket
132(w) x 30(h) x 105mm(d)

WB10.02 £44.10



Bottle basket
241(w) x 45(h) x 112mm(d)

WB80.02 £73.00



Double bottle basket
241(w) x 260(h) x 112mm(d)

WB90.02 £167.00

GRAB BARS



GUARANTEE



PVD
PVD hardwearing
& scratch resistant
coating. Brushed
brass finish



CAPITAL GRAB BARS



PAIR WITH
CAPITAL
ACCESSORIES
SEE PAGE 280



Grab bars

| | | | | |
|----|--------------------------------|--------------------------------------|---------|---------|
| 01 | Square modern grab bar chrome | 295(w) x 25(h) x 65mm(d) | 1582.02 | £115.00 |
| 02 | Round modern grab bar chrome | 360(w) x 58(h) x 75mm(d) | 1482.02 | £115.00 |
| 03 | 45° angled grab bar chrome | 460(w) x 240(h) x 120(d) x 25mm(dia) | 2386.02 | £113.50 |
| 04 | Grab bar chrome | 430(w) x 65(h) x 80(d) x 25mm(dia) | 2382.02 | £94.20 |
| 05 | Capital grab bar brushed brass | 505(w) x 25(h) x 75mm(d) | DC7050 | £161.00 |
| 06 | Capital grab bar black | 505(w) x 25(h) x 75mm(d) | DC7049 | £139.50 |
| 07 | Capital grab bar chrome | 505(w) x 25(h) x 75mm(d) | DC7048 | £123.50 |





LIGHTING, MIRRORS & CABINETS



Explore our lighting, mirror & cabinet

COLLECTION

Our team of product designers are experts in the art of blending functionality with elegance, designing mirrors, cabinets, and lighting solutions that not only elevate your space but also enhance your daily routine. With a keen eye for detail and a passion for innovation, they focus on developing products that seamlessly integrate with each other, ensuring your bathroom is not just beautifully lit but also perfectly coordinated.



1

3

4

Bathroom lighting

COMPLETE LIGHTING SOLUTION

With over forty years of experience, we know it's the details that matter. A great lighting design is key to a high-end bathroom that looks great in every light.

Our lights can be used conventionally or can be connected by WiZ allowing all lights to work seamlessly together and be personalised to your routines and preferences. All our lighting is IP44 rated for safe use in the bathroom.



1

WALL LIGHTING

Available in Fluted, Traditional & Globe styling see pages 296-298 for full details



2

PENDANT LIGHTING

Available in Fluted and Globe styling see pages 296-297 for full details



3

DOWN LIGHTING

Ceiling down lighting available see page 398 for full details



4

STRIP LIGHTING

Strip lighting available to use under furniture units or in wall alcoves see page 299 for full details



5

MIRRORS

Connected by WiZ mirrors also available see page 314-315 for full details

Discover

BEAUTIFULLY LIT BATHROOMS



CONNECTED BY WIZ

Although our lights can be used conventionally they can also be used as smart lights when connected by WiZ making them completely customisable allowing you to set, schedule and adjust your lighting scheme within the WiZ app. Seamlessly integrated with your choice of smart speaker, all of our connected by WiZ products can be voice activated, and further simplified with our convenient smart button.



SMART BUTTON CONTROL OPTION

Enjoy quick and easy control of your lights with the WiZ smart button. This battery operated device enables direct control of your lighting scheme, without going through the app. The smart button can be easily affixed to your wall, without screws, in a place convenient to you.

CONTROLLING YOUR LIGHTING

Smart bathroom lighting connected by WiZ
Also available non-smart.



or



or



COMMAND FROM YOUR MOBILE

Set up and control your lighting with your mobile device

SMART BUTTON

Turn your lights on/off & control the brightness with your smart button

AUTOMATE THROUGH SPACESENSE™

When 2 products connected by WiZ are used in one space 2m apart



SCAN TO FIND OUT MORE ABOUT SPACESENSE™



GUARANTEE
for consumables
(bulbs and switches)



GUARANTEE
against manufacturing
defects



LIGHTING STYLES

Create beautiful spaces and points of distinction in your bathroom with our lighting designs. Available in two finishes, in globe or fluted styles, our extensive range of wall lights and pendants offer form and functionality. Further enhance your bathroom with ambient lighting strip, illuminated mirrors and downlights from the collection. All designed specifically for use in the bathroom environment.

Our lighting collection benefits from a 3 year guarantee, covering manufacturing defects and a 2 year guarantee for consumables. (bulbs and switches), giving you complete peace of mind.



Make a design statement

FLUTED LIGHTING



GUARANTEE
against
manufacturing
defects



GUARANTEE
consumables
(bulbs and
switches)



LIGHTING VIDEO
Scan to explore
the fluted lighting

Connected by



FLUTED LIGHTING CONNECTED BY WiZ

- Connected by WiZ to link to your smart home
- IP44 rated
- Wall mounted and ceiling pendant variations
- Black and brass fluted texture finishes available
- Pendant light cable length 3m
- GU10 Max 5W
- Includes WiZ GU10 Smart Bulb (1 x pendants and 2 x for wall lights)

| Wall Lights | Code | W x H x Dmm | RRP |
|---------------|-------------|----------------|---------|
| Black | WL02-BL-WIZ | 100 x 202 x 92 | £187.50 |
| Brushed Brass | WL02-BR-WIZ | 100 x 202 x 92 | £198.50 |

| Pendant Lights | Code | W x H x Dmm | RRP |
|----------------|-------------|---------------|---------|
| Black | PL02-BL-WIZ | 55 x 250 x 55 | £123.50 |
| Brushed Brass | PL02-BR-WIZ | 55 x 250 x 55 | £134.00 |



WiZ Smart Switch Button
929003501322 £40.70

CONVENTIONAL FLUTED LIGHTING

- IP44 rated
- Wall mounted and ceiling pendant variations
- Black and brass fluted texture finishes available
- Pendant light cable length 3m
- Recommended Bulb - GU10 Max 5W (bulb not included)

| Wall Lights | Code | W x H x Dmm | RRP |
|---------------|---------|----------------|---------|
| Black | WL02-BL | 100 x 202 x 92 | £139.50 |
| Brushed Brass | WL02-BR | 100 x 202 x 92 | £150.00 |

| Pendant Lights | Code | W x H x Dmm | RRP |
|----------------|---------|---------------|---------|
| Black | PL02-BL | 55 x 250 x 55 | £96.20 |
| Brushed Brass | PL02-BR | 55 x 250 x 55 | £107.50 |

Distinctly modern design

GLOBE LIGHTING



3
YEAR

GUARANTEE
against
manufacturing
defects



2
YEAR

GUARANTEE
consumables
(bulbs and
switches)



apex

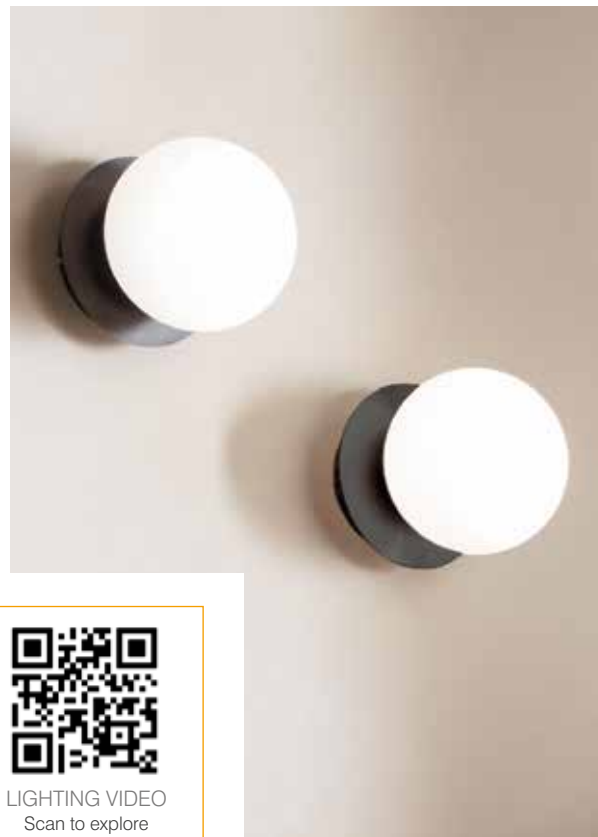

LIGHTING VIDEO
Scan to explore
the globe lighting

Connected by



GLOBE LIGHTING CONNECTED BY WiZ

- Connected by WiZ to link to your smart home
- IP44 rated
- Wall mounted and ceiling pendant variations
- Black and brass finishes available
- Glass globe in opal white finish
- Pendant light cable length 3m
- E14 Max 25W
- Includes Smart WiZ 40W P45 E14 Bulb

| Wall Lights | Code | W x H x Dmm | RRP |
|---------------|---------------|-----------------|---------|
| Black | WL01-BL-W-WIZ | 150 x 150 x 193 | £241.00 |
| Brushed Brass | WL01-BR-W-WIZ | 150 x 150 x 193 | £252.00 |

| Pendant Lights | Code | W x H x Dmm | RRP |
|----------------|---------------|-----------------|---------|
| Black | PL01-BL-W-WIZ | 150 x 202 x 150 | £177.00 |
| Brushed Brass | PL01-BR-W-WIZ | 150 x 202 x 150 | £187.50 |



WiZ Smart Switch Button
929003501322 £40.70

CONVENTIONAL GLOBE LIGHTING

- IP44 rated
- Wall mounted and ceiling pendant variations
- Black and brass finishes available
- Glass globe in opal white finish
- Pendant light cable length 3m
- Recommended Bulb - E14 P45 Max. 25W
(Bulb not included)

| Wall Lights | Code | W x H x Dmm | RRP |
|---------------|-----------|-----------------|---------|
| Black | WL01-BL-W | 150 x 150 x 193 | £214.00 |
| Brushed Brass | WL01-BR-W | 150 x 150 x 193 | £225.00 |

| Pendant Lights | Code | W x H x Dmm | RRP |
|----------------|-----------|-----------------|---------|
| Black | PL01-BL-W | 150 x 202 x 150 | £144.50 |
| Brushed Brass | PL01-BR-W | 150 x 202 x 150 | £155.00 |

Fluted classic elegance

TRADITIONAL LIGHTING



GUARANTEE
against
manufacturing
defects



GUARANTEE
consumables
(bulbs and
switches)



WALCOT WALL LIGHTING

- IP44 Rated
- Wall Mounted
- Fluted Glass housing
- Recommended Bulb - G9 Max 6W (not included)
- Can be mounted facing down or up

| Wall Lights | Code | W x H x Dmm | RRP |
|----------------|---------|-----------------|--------|
| Chrome | WL03-CH | 115 x 212 x 100 | £99.00 |
| Brushed Brass | WL03-BR | 115 x 212 x 100 | £99.00 |
| Brushed Nickel | WL03-BN | 115 x 212 x 100 | £99.00 |



DOWN LIGHTS

FEATURES

- Connected by WiZ to link to your smart home (bathroom)
- IP65 - suitable for use in showering spaces
- Matt white finish
- Semi recessed design for glare control
- Connected by WiZ version includes WiZ GU10 Smart Bulb
- Conventional version bulb not included
recommended Bulb - GU10 Max 5W

Connected by
WiZ

| Down light Connected by WiZ | Code | W x H x Dmm (inc bracket) | RRP |
|--------------------------------|--------------|------------------------------|---------|
| Single | DL01-W-WIZ | 85 x 135 x 85 | £45.50 |
| 2 Pack | DL01-W-WIZ-2 | 85 x 135 x 85 | £88.20 |
| 3 Pack | DL01-W-WIZ-3 | 85 x 135 x 85 | £131.00 |
| 4 Pack | DL01-W-WIZ-4 | 85 x 135 x 85 | £173.00 |

| Conventional Down light | Code | W x H x Dmm (inc bracket) | RRP |
|----------------------------|----------|------------------------------|--------|
| Single | DL01-W | 85 x 135 x 85 | £21.50 |
| 2 Pack | DL01-W-2 | 85 x 135 x 85 | £40.20 |
| 3 Pack | DL01-W-3 | 85 x 135 x 85 | £58.90 |
| 4 Pack | DL01-W-4 | 85 x 135 x 85 | £76.50 |

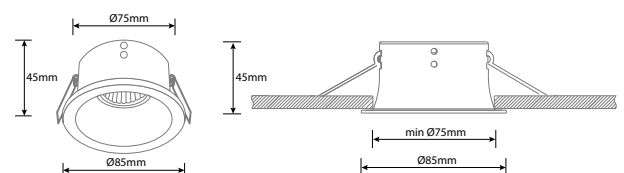

STRIP LIGHTS

3
YEAR

GUARANTEE
against
manufacturing
defects

2
YEAR

GUARANTEE
consumables
(bulbs and
switches)

apex



FEATURES

Connected by

WIZ

- Connected by WIZ to link to your smart home
- IP65 rated
- Driver box included
- Suitable for use under wall hung furniture, in nooks and behind baths to create ambient lighting

| Strip Light Connected by WIZ | Code | Dimensions | RRP |
|---------------------------------|---------------|------------|---------|
| LED STRIP IP65 | WIZLEDKIT-450 | 450mm | £155.00 |
| LED STRIP IP65 | WIZLEDKIT-750 | 750mm | £161.00 |



WIZ Smart Switch Button
929003501322 £40.70



Discover

ROPER RHODES MIRRORS



GUARANTEE
against manufacturing
defects



GUARANTEE
on all electrical
components



MOTION SENSOR
VIDEO



MOTION SENSOR TECHNOLOGY

Add convenience and efficiency with motion activated lighting — it turns on as you walk into your bathroom and off when you leave, saving energy.

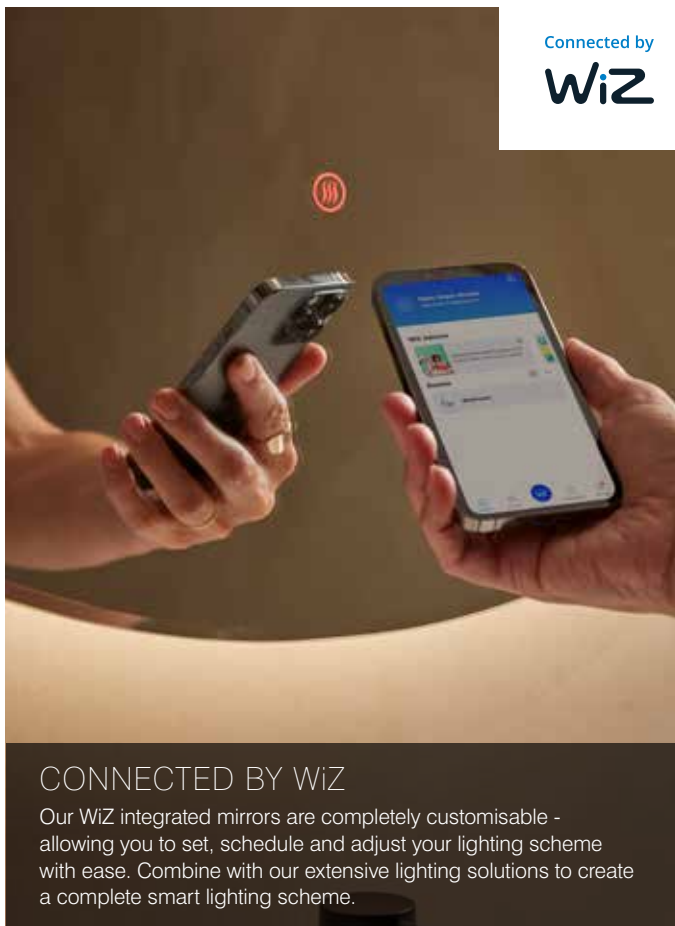

Connected by
WiZ

CONNECTED BY WiZ

Our WiZ integrated mirrors are completely customisable - allowing you to set, schedule and adjust your lighting scheme with ease. Combine with our extensive lighting solutions to create a complete smart lighting scheme.



BEYOND REFLECTIONS

Merging the latest in technological advances with our signature style, our range of mirrors and cabinets offer intelligent storage and features.

Whether you're adding a focal point for your bathroom, need to hide away cosmetics and toiletries or just want to add a mirror for purely practical reasons, our range has all the options you'll need.





WHAT IS IP44?

IP44 is a rating that tells you how well a product is protected against dust and water. "IP" stands for Ingress Protection, and the two numbers that follow it each have a specific meaning:

The first number (4) means the product is protected against solid objects larger than 1mm, like small tools or wires. It's not fully dust-proof, but it does block most solid particles.

The second number (4) means it's protected against water splashes from any direction.

All Roper Rhodes illuminated mirrors and cabinets carry an IP44 rating, making them suitable for Bathroom Zone 2 and areas outside the zones. This gives you excellent flexibility when planning your bathroom layout.

ZONE 1

Roper Rhodes recommends that products installed in Zone 1 are a minimum of IP65

ZONE 2

Electrical fittings in this zone require a minimum rating of IP44 (splash-proof)

OUTSIDE ZONES

Electrical fittings in this zone require a minimum rating of IP20

MADE FOR REAL LIFE

Every mirror we make is subjected to an impact test that simulates accidental bumps and slips. By applying concentrated force to key points on the glass, we ensure it stays securely in its frame—even under stress, giving you the confidence it will remain durable in your bathroom.

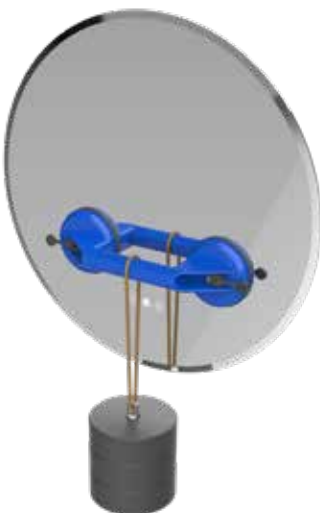

ENGINEERED FOR THE BATHROOM

Static shear test Each of our mirrors is subjected to a bond-strength test in which a 30 kg load is applied for 10 days. The strict pass requirement is 0mm of slippage guaranteeing your mirror will remain looking as it should.



STYLE MEETS EFFICIENCY

LEDs are a sustainable, energy-efficient, long-lasting lighting option. They stay cool for added safety and offer dimming and diverse styles to suit any space or mood.

Discover

ROPER RHODES MIRRORS



SEE EVERY DETAIL

A 3x magnifying vanity mirror makes beauty routines effortless - from flawless makeup to precise eyebrow shaping - while reducing eye strain, and its versatile uses, including contact lens application, make it an essential beauty tool.

DEPTH OF CHOICE

Our mirror collection ranges from elegant pill shapes to eye catching arch designs, our mirrors include many features including industry leading ghost glass technology and are available in a variety of finishes - from classic black to luxurious brushed bronze.



CONTROL RELIABILITY

Switches are tested through **100,000 cycles** to ensure durability and reliability throughout the products lifetime.

6000K

Cool to warm

2700K



FIND YOUR PERFECT LIGHT

Transform your space with ingenious colour changing technology. Invigorate your morning with bright, crisp daylight, or wrap yourself in a soft, warm glow and as you spend an hour relaxing in the bath. With a wide spectrum LED ranging from 2700-6000K, you can easily shift your mirror lighting from cool and white to warm.



PORTABLE MAGNIFYING MIRROR

From everyday make-up needs, to getting that super close shave, Loop makes the perfect partner in your bathroom. See more on page 306.



GHOST GLASS TECHNOLOGY

Experience elegant innovation with our ghost glass bathroom mirrors. When off, they display a sleek, seamless surface. With a touch, the edges glow softly, revealing a striking halo of light.



LED LIGHTING

Energy efficient LEDs provide high quality and bright illumination whilst being 80% more efficient than older incandescent lights



VARIABLE WARM TO COOL & DIMMABLE LEDs

Flexibility to adjust the LED warmth and brightness from an invigorating daylight white (6000K) to a relaxing warm white (2700K)



INFRARED SENSOR

Easy to use, an infrared sensor allows you to control the mirror with just the wave of your hand without touching the mirror



STEAM-FREE

Maintain a steam-free mirror reflection in the bathroom with an integrated heated demister pad



TOUCH CONTROLS

Touch controls offer easy on/off and feature access right from the mirror



TWO-PIN CHARGING SOCKET

Conveniently positioned, this charging socket keeps your electric toothbrush or shaver fully charged



USB SOCKET

Easily accessed USB & USB-C sockets to keep your devices fully charged



IP44 RATED

Mirrors indicated with this symbol are IP44 rated, making them suitable for use within zone 2 of the bathroom



MAGNIFYING MIRROR

Take a closer look at your reflection with our magnifying vanity mirrors



GHOST GLASS

When off, the mirror is sleek and seamless; with a touch, its edges softly illuminate with a halo effect



MOTION SENSOR

Enhances convenience and efficiency with motion-activated lighting - automatically turns on as you approach and off when no motion is detected



CONNECTED BY WIZ

to link to your smart home



FRAME OPTIONS

Discover our mirror frame finish options up close



SHAPES

Explore the wide variety of mirror shapes we offer



ORIENTATION

Choose to install your mirror landscape or portrait















SLIM DEPTH

Our slim depth mirrors protrude 30mm or less from the wall

Making the perfect choice

MIRROR FEATURES & BUYING GUIDE

Use the table below to guide you around our mirror collection and help you find the features which are important to you when selecting your new mirror.

| | Connected by WIZ | Motion sensor | LED lighting | Variable warm to cool & dimmable LEDs | Ghost glass | Infrared sensor | Touch controls | Heated demister | Two-pin charging socket | USB/USB-C charging socket | Magnifying mirror | Frame options | Shapes | Landscape & portrait |
|---------------|---|---|---|---|---|---|---|---|--|---|---|---|---|---|
| |  |  |  |  |  |  |  |  |  |  |  |  |  |  |
| Loop | | | ● | ● | | | ● | ● | | | ● | ● | ● | |
| Walcot | | ● | ● | ● | ● | | ● | ● | | | | ● | ● | |
| Faber | | ● | ● | ● | ● | | ● | ● | | | | | ● | ● |
| Phantom | | ● | ● | ● | | | ● | ● | | | | | ● | ● |
| Ritual | ● | | ● | ● | | | ● | ● | | | | | ● | ● |
| Link | ● | | ● | ● | | | ● | ● | | | | | ● | |
| Leap Pro | | | ● | ● | | | ● | ● | ● | ● | | | | |
| Calibre | | | ● | ● | | | ● | ● | | | | | ● | ● |
| Eminence | | | ● | ● | | ● | | ● | | | | | ● | ● |
| Frame | | | ● | ● | | ● | | ● | | | | ● | ● | ● |
| Thesis | | | | | | | | | | | | ● | ● | ● |
| Traditional | | | | | | | | ● | | | | | | ● |
| Elle & Hannah | | | | | | | | | | | | | | ● |



GUARANTEE
against
manufacturing
defects



GUARANTEE
on all
electrical
components



Framed wall & vanity mirror

LOOP

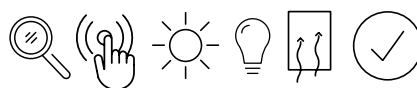

GUARANTEE
against
manufacturing
defects



GUARANTEE
on all
electrical
components

- Wall mirror with detachable Loop vanity mirror, wireless charging stand & USB-C cable included
- Vanity mirror wireless charging ring on bottom right of large wall mirror
- Three touch control sensor
- 3x magnification
- Brightness control
- Colour changing technology with presets and scrolling
- Separate demister control with auto-off
- IP55 rated



ON MIRROR WIRELESS CHARGING & MAGNETIC ATTACHMENT

With the internal magnetic attachment, you can place your Loop vanity mirror anywhere. Set it at the perfect height on your coordinating wall mirror, or place on the dedicated charging ring to keep it powered up.



| Loop Framed & Vanity Mirrors | Code | Finish | W x H x Dmm | RRP |
|---------------------------------|-----------|---------------|----------------|---------|
| 600 wall mirror & vanity mirror | VMM60CUBL | Black | 600 x 600 x 34 | £475.00 |
| 800 wall mirror & vanity mirror | VMM80CUBL | Black | 800 x 800 x 34 | £575.00 |
| 600 wall mirror & vanity mirror | VMM60CUBR | Brushed brass | 600 x 600 x 34 | £475.00 |
| 800 wall mirror & vanity mirror | VMM80CUBR | Brushed brass | 800 x 800 x 34 | £575.00 |
| Vanity mirror | VM03 | | 140 x 140 | £99.00 |

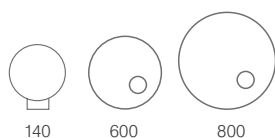

Backlit design

LOOP

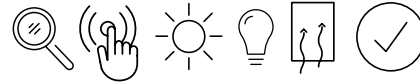

10
YEAR

GUARANTEE
against
manufacturing
defects

2
YEAR

GUARANTEE
on all
electrical
components



- Wall mirror with detachable Loop vanity mirror, wireless charging stand & USB-C cable included
- Vanity mirror wireless charging ring on bottom right of large wall mirror
- Three touch control sensor
- 3x magnification
- Ambient backlighting with brightness control
- Colour changing technology with presets and scrolling
- Separate demister control with auto-off
- IP55 rated

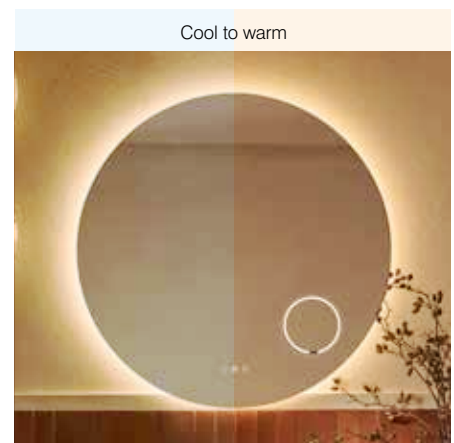

| Loop Backlit Mirror |  | Code | W x H x Dmm | RRP |
|---------------------|---|-----------|----------------|---------|
| 600 Circular | | VMM60CUAM | 600 x 600 x 25 | £450.00 |
| 800 Circular | | VMM80CUAM | 800 x 800 x 25 | £550.00 |
| <hr/> | | | | |
| Vanity mirror | | VM03 | 140 x 140 | £99.00 |

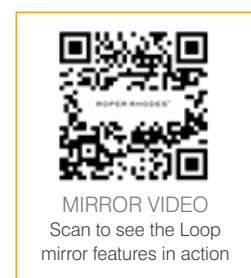
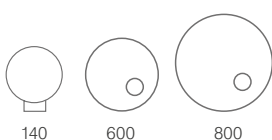

PAIR WITH
OUR WALCOT
COLLECTION
SEE PAGE 18



- Modular design – Choose between standard frame, traditional wall hangers or hanging straps in brown or black
- Innovative ghost glass technology for a clean aesthetic when off
- Motion sensing with auto-off (optional setting)
- Three touch sensor
- Colour changing technology with presets and scrolling
- Brightness control
- Separate demister control with auto-off
- Aluminium frame in on-trend finishes
- IP44 rated

GHOST GLASS DESIGN
When off, the lighting around the mirror vanishes into the mirror's reflection

Elegance reimagined

WALCOT

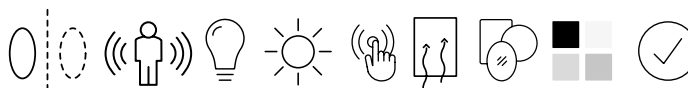

10
YEAR

GUARANTEE
against
manufacturing
defects

2
YEAR

GUARANTEE
on all
electrical
components

STRAPS



NO FIXINGS



WALL BRACKETS



Wall brackets can be positioned
landscape or portrait

STEP 1 Pick your shape

Use the base code

| Walcot Mirrors | Base code | W x H x Dmm |
|----------------|-----------|----------------|
| Arch 400x800 | WAM40A | 410 x 800 x 42 |
| Pill 400x800 | WAM40P | 400 x 800 x 42 |
| Pill 500x800 | WAM50P | 500 x 800 x 42 |
| Circular 600 | WAM60C | ø600 x 42 |
| Circular 800 | WAM80C | ø800 x 42 |
| Circular 1000 | WAM10C | ø1000 x 42 |

STEP 2 Pick your frame finish

Add the suffix below to your base code

| | Black | Brass | Nickel | Bronze | RRP |
|---------------|-------|-------|--------|--------|---------|
| Arch 400x800 | -BL | -BR | -BN | -BZ | £355.00 |
| Pill 400x800 | -BL | -BR | -BN | -BZ | £365.00 |
| Pill 500x800 | -BL | -BR | -BN | -BZ | £375.00 |
| Circular 600 | -BL | -BR | -BN | -BZ | £350.00 |
| Circular 800 | -BL | -BR | -BN | -BZ | £430.00 |
| Circular 1000 | -BL | -BR | -BN | -BZ | £550.00 |

STEP 3 Pick you accessory (optional)

Add the suffix below to your finish code



Wall Brackets
-F1
£45.00



Brown Strap*
-F2
£45.00



Black Strap*
-F3
£45.00

TOP TIP

When ordering Walcot mirrors please remember to follow **steps 1-3**.
Shown here is an example code for **WAM40P-BL-F1**. This would generate
an order for a Pill 400/800 in black with wall brackets.

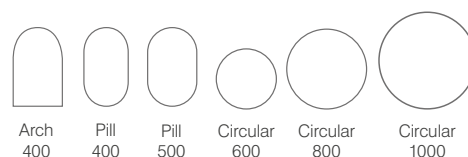

*Straps are not compatible with 1000 circular variants



Endless shapes, infinite choices

FABER

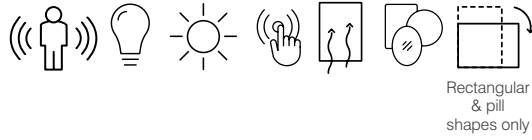

10
YEAR

GUARANTEE
against
manufacturing
defects

2
YEAR

GUARANTEE
on all
electrical
components



- Backlit, ambient lighting
- High-end bevel edge detailing
- Motion sensing with auto-off (optional feature)
- Three touch sensor
- Colour changing technology with presets and scrolling
- Brightness control
- Separate demister control with auto-off
- 14 orientations to suit any project
- IP44 rated



MOTION SENSOR
The mirror automatically lights up when it detects motion and turns off when no movement is sensed

| Faber Mirrors | Code | W x H x Dmm | RRP |
|---------------|----------|-----------------|---------|
| Circular 600 | FBM60C | ø600 x 29 | £275.00 |
| Circular 800 | FBM80C | ø800 x 29 | £325.00 |
| Circular 1000 | FBM100C | ø1000 x 29 | £375.00 |
| Arch | FBM4090A | 400 x 900 x 29 | £299.00 |
| 600x800 | FBM6080 | 600 x 800 x 29 | £299.00 |
| 1000x450 | FBM1045 | 1000 x 450 x 29 | £325.00 |
| 1200x500 | FBM1250 | 1200 x 500 x 29 | £399.00 |
| Pill 400 | FBM4090P | 400 x 900 x 29 | £275.00 |
| Pill 500 | FBM5090P | 500 x 900 x 29 | £300.00 |

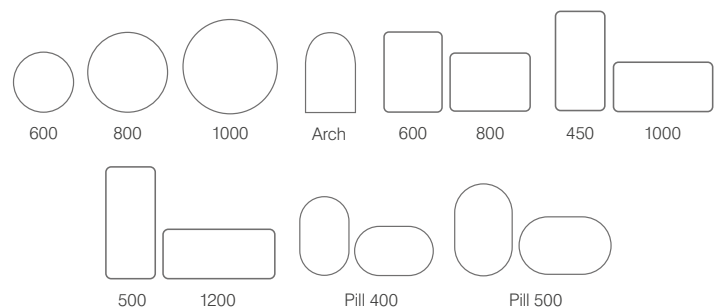

Reflections reinvented with ghost glass

PHANTOM

Rectangular only

GUARANTEE against manufacturing defects 10 YEAR

GUARANTEE on all electrical components 2 YEAR



- Innovative ghost glass technology to provide a clean aesthetic when the product is off
- Mirrored frame to reflect your wall finish and create a floating look
- Motion sensing with auto-off (optional feature)
- Three touch sensor
- Colour changing technology with presets and scrolling
- Brightness control
- Separate demister control with auto-off
- 10 shapes and orientations to suit any bathroom
- IP44 rated



GHOST GLASS DESIGN
When off, the lighting around the mirror vanishes into the mirror's reflection

| Phantom Mirrors | Code | W x H x Dmm | RRP |
|-----------------|--------|----------------|---------|
| Circular 600 | PHM60C | ø595 x 35 | £350.00 |
| Circular 800 | PHM80C | ø800 x 35 | £450.00 |
| Circular 1000 | PHM10C | ø1000 x 35 | £550.00 |
| Arch | PHM40A | 405 x 795 x 35 | £355.00 |
| 400 Pill | PHM40P | 400 x 800 x 35 | £365.00 |
| 500 Pill | PHM50P | 500 x 800 x 35 | £375.00 |
| 500x700 | PHM050 | 500 x 700 x 35 | £350.00 |
| 600x800 | PHM060 | 595 x 795 x 35 | £400.00 |

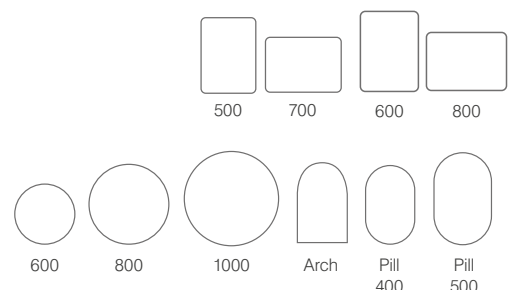



077

VER

Smart home design

RITUAL

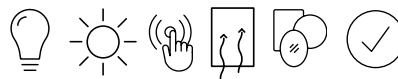

Connected by
WIZ

10
YEAR

GUARANTEE
against
manufacturing
defects

2
YEAR

GUARANTEE
on all
electrical
components

- On-trend backlit design with chamfered glass detailing
- Heated demist pad with energy saving 30min auto-off feature
- Connected by WIZ to link to your smart home
- Improve your wellbeing with circadian rhythm setup and scheduling
- Colour changing and dimming LEDs
- Controlled using WIZ Smart button, WIZ App or your choice of smart speaker (WIZ smart button included)
- SpaceSense™ compatible
- Fits seamlessly into existing smart home setup
- IP44 rated

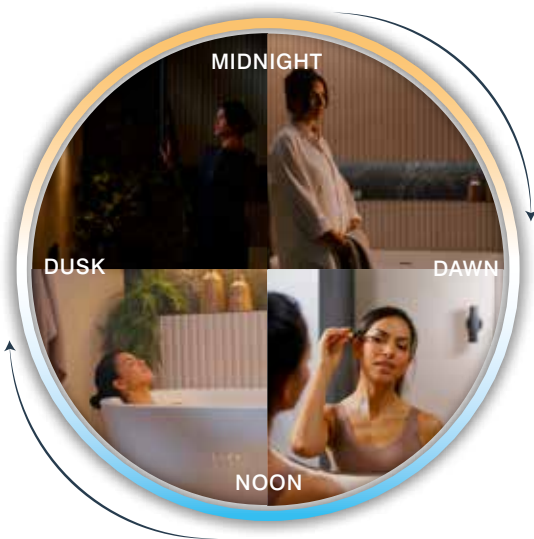

BATHROOM LIGHTING ROUTINE

Customisable brightness & warmth to match your mood, schedule to turn on in-line with your routine.

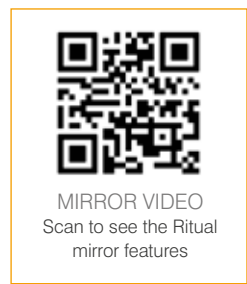

CONNECTED BY WIZ
Smart home compatible
with app control



INCLUDES SMART BUTTON
Choose to turn your lights on and off
& control the brightness with your
smart button

| Ritual Mirrors | Code | W x H x Dmm | RRP |
|----------------|---------|----------------|---------|
| Circular 600 | RLM60C | ø600 x 40 | £455.00 |
| Circular 800 | RLM80C | ø800 x 40 | £540.00 |
| Circular 1000 | RLM100C | ø1000 x 40 | £620.00 |
| 500/800 | RLM050 | 500 x 800 x 40 | £482.00 |
| 600/900 | RLM060 | 600 x 900 x 40 | £515.00 |

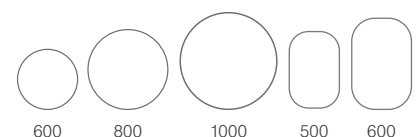

Smart home design

LINK

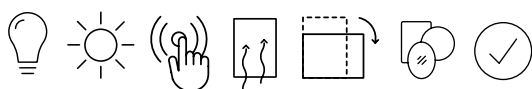

Connected by
WIZ

10
YEAR
GUARANTEE
against
manufacturing
defects

2
YEAR
GUARANTEE
on all
electrical
components

- Functional & stylish perimeter lighting
- Heated demist pad with energy saving 30min auto-off feature
- Connected by WiZ to link to your smart home
- Improve your wellbeing with circadian rhythm setup and scheduling
- Colour changing and dimming LEDs
- Controlled using WiZ Smart button, WiZ App or your choice of smart speaker (WiZ smart button included)
- SpaceSense™ compatible
- Fits seamlessly into existing smart home setup
- IP44 rated



COMPATIBLE
WITH WIZ
LIGHTING
RANGES
P296-297

MIRROR VIDEO
Scan to see the Link
mirror features

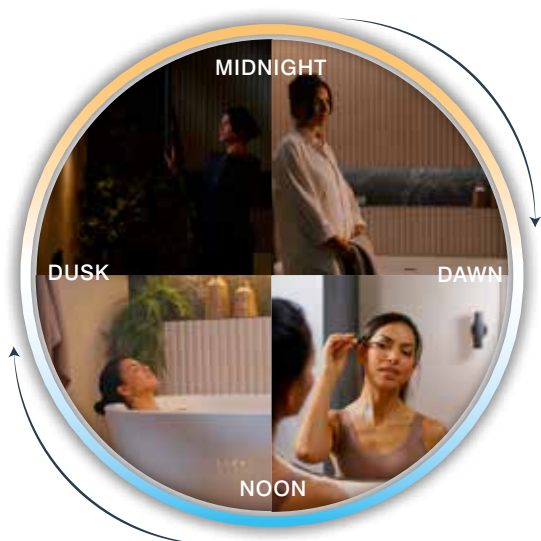

BATHROOM LIGHTING ROUTINE
Customisable brightness & warmth to match your mood, schedule to turn on in-line with your routine.



CONNECTED BY WIZ
Smart home compatible
with app control



INCLUDES SMART BUTTON
Choose to turn your lights on and off
& control the brightness with your
smart button

| Link Mirrors | Code | W x H x Dmm | RRP |
|---------------------|--------|----------------|---------|
| Circular 600 | LKM60C | ø600 x 40 | £455.00 |
| Circular 800 | LKM80C | ø800 x 40 | £540.00 |
| Pill | LKM50P | 500 x 800 x 40 | £482.00 |
| 600/800 | LKM060 | 600 x 800 x 40 | £515.00 |

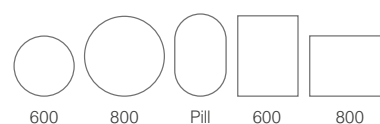

Sleek design. Smart power

LEAP PRO

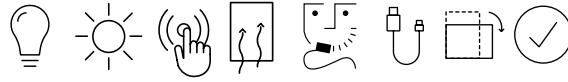

10
YEAR

GUARANTEE
against
manufacturing
defects

2
YEAR

GUARANTEE
on all
electrical
components



- Modern, slim lighting style
- Two-pin shaving socket with isolating rocker switch
- USB & USB-C shaver ports
- Dual touch sensor
- Colour changing technology
- Brightness control
- Separate demist with auto-off
- IP44 rated

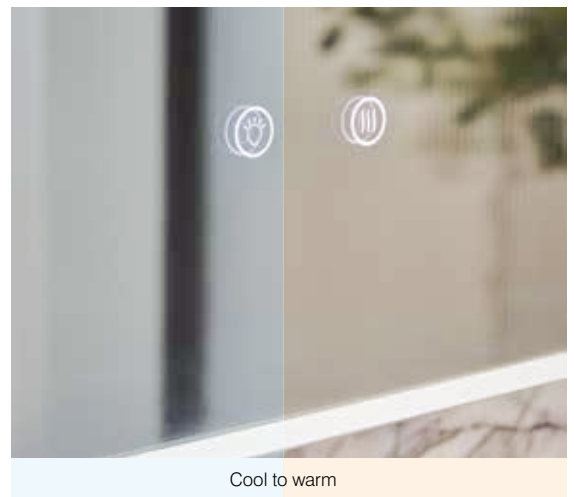

| Leap Pro Mirrors | Code | W x H x Dmm | RRP |
|------------------|--------|-----------------|---------|
| 500x700 | LPM050 | 500 x 700 x 65 | £325.00 |
| 600x800 | LPM060 | 600 x 800 x 65 | £350.00 |
| 1000x500 | LPM100 | 1000 x 600 x 65 | £400.00 |

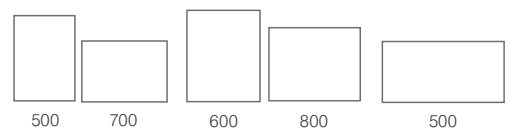

Effortless style

CALIBRE

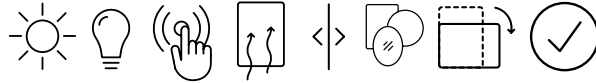

Rectangle shapes only

10
YEAR
GUARANTEE
against
manufacturing
defects

2
YEAR
GUARANTEE
on all
electrical
components

- Available in 8 sizes and orientations
- Adjustable LED colour temperature & brightness
- Three touch sensor
- High quality acrylic lighting diffuser for soft, even lighting
- Separate demist with auto-off
- Rectangular version can be hung portrait or landscape
- IP44 rated

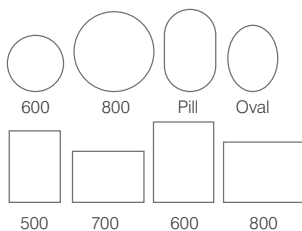

| Calibre Mirrors | Code | W x H x Dmm | RRP |
|-----------------|--------|----------------|---------|
| Circular ø600 | CLM60C | 600 x 600 x 29 | £232.00 |
| Circular ø800 | CLM80C | 800 x 800 x 29 | £297.00 |
| Pill | CLM50P | 500 x 800 x 29 | £250.00 |
| Oval | CLM50V | 500 x 800 x 29 | £241.00 |
| 500x700 | CLM050 | 500 x 700 x 29 | £260.00 |
| 600x800 | CLM060 | 600 x 800 x 29 | £306.00 |

Distinctly modern design

EMINENCE

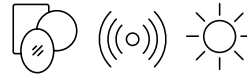

Rectangle shapes only



GUARANTEE against manufacturing defects



GUARANTEE on all electrical components



- Infrared switch controlled by contactless hand movements
- Adjustable LED colour temperature & brightness
- Heated demister pad prevents mirror steaming up
- IP44 rated

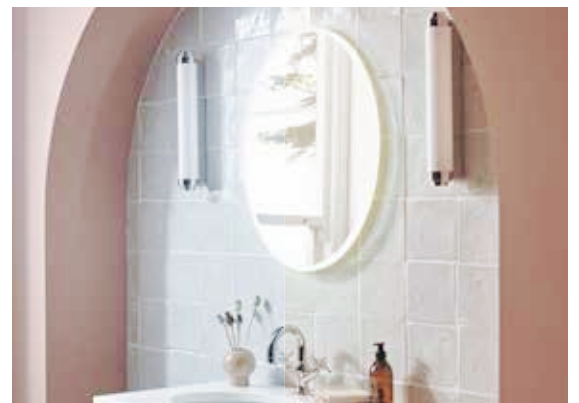

ADJUSTABLE LIGHTING
Cool to warm

| Eminence Mirrors | Code | W x H x Dmm | RRP |
|------------------|---------|----------------|---------|
| Circular 550 | EM55CAL | ø550 x 35 | £354.00 |
| Circular 800 | EM80CAL | ø800 x 35 | £447.00 |
| Pill | EM80PAL | 500 x 800 x 35 | £466.00 |
| Oval | EM65OAL | 490 x 650 x 35 | £397.00 |
| 500/700 | EM70RAL | 500 x 700 x 35 | £411.00 |
| 600/800 | EM80RAL | 600 x 800 x 35 | £463.00 |

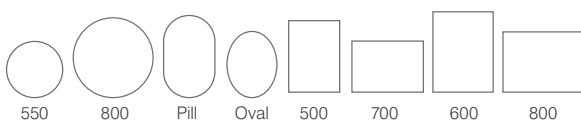

Make a design statement

FRAME

Rectangle shapes only

10 YEAR GUARANTEE against manufacturing defects

2 YEAR GUARANTEE on all electrical components

- Aluminium framed mirrors
- Infrared switch controlled by contactless hand movements
- Adjustable LED colour temperature & brightness
- Heated demister pad prevents mirror steaming up
- Available in a brushed brass or black finish
- IP44 rated



ADJUSTABLE LIGHTING
Cool to warm

| Frame Mirrors | W x H x Dmm | Brushed Brass | RRP | Black | RRP |
|---------------------|-----------------|---------------|----------------|---------|----------------|
| Circular 600 | ø600 x 38 | FR60RB | £344.00 | FR60RG | £326.00 |
| Circular 800 | ø800 x 38 | FR80RB | £460.00 | FR80RG | £440.00 |
| Pill | 500 x 800 x 38 | - | | FR50PG | £368.00 |
| Oval | 500 x 700 x 38 | FR50VB | £370.00 | FR50VG | £343.00 |
| 500/700 | 500 x 700 x 38 | - | | FR50SG | £368.00 |
| 600/800 | 600 x 800 x 38 | - | | FR60SG | £440.00 |
| 1200 | 1200 x 600 x 38 | - | | FR120SG | £585.00 |

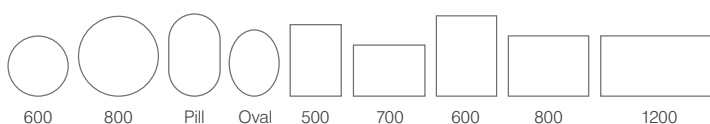

Designer edge

THESIS



Rectangle shapes only



GUARANTEE against manufacturing defects



GUARANTEE on all electrical components

- Framed with a high quality aluminium trim in a gunmetal, brushed brass or matt black finish
- Rectangular versions can be mounted landscape & portrait
- Compatible with the Loop vanity mirror
- Can be purchased with or without the Loop vanity mirror



3X MAGNIFICATION VANITY MIRROR
A handheld vanity mirror with 3x magnification. The mirror can be used handheld or freestanding and is supplied with a wireless charging stand and USB cable.

| Thesis Mirror | W x H x Dmm | Black | RRP | Brushed Brass | RRP | Gunmetal | RRP |
|---------------------|----------------|-----------|---------|---------------|---------|-----------|---------|
| Circular 600 | ø600 x 38 | TNM60C | £139.50 | TNM60C-BR | £161.00 | TNM60C-GM | £161.00 |
| Circular 800 | ø800 x 38 | TNM80C | £198.50 | TNM80C-BR | £234.50 | TNM80C-GM | £234.50 |
| Pill | 500 x 800 x 38 | TNM50P | £198.50 | TNM50P-BR | £218.50 | TNM50P-GM | £218.50 |
| Oval | 500 x 700 x 38 | TNM50V | £188.50 | TNM50V-BR | £209.50 | - | - |
| 450/700 | 450 x 700 x 38 | TNM045 | £150.00 | TNM045-BR | £166.50 | TNM045-GM | £166.50 |
| 600/800 | 600 x 800 x 38 | TNM060 | £188.50 | TNM060-BR | £208.00 | TNM060-GM | £208.00 |
| Arch | 500 x 800 x 38 | TNM50A-BL | £182.00 | TNM50A-BR | £200.50 | TNM50A-GM | £200.50 |

| Vanity Mirror | Code | W x H x Dmm | RRP |
|---------------|------|-------------|--------|
| Vanity Mirror | VM03 | 140 x 140 | £99.00 |

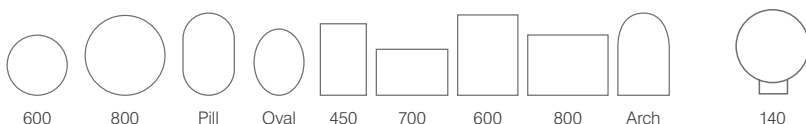

Bevelled mirror design

TRADITIONAL, ELLE & HANNAH

Traditional mirrors only

10 YEAR GUARANTEE against manufacturing defects

2 YEAR GUARANTEE on all electrical components

- Bevelled edged mirrors
- Slim depth design
- Heated demister pad prevents mirror steaming up (Traditional mirrors only)



| Traditional Mirrors | Code | W x H x Dmm | RRP | Mirrors | Code | W x H x Dmm | RRP |
|---------------------|---------|----------------|---------|----------------|--------|----------------|---------|
| 430/700 | WMB2022 | 430 x 700 x 30 | £280.00 | Elle 405/595 | MPS403 | 405 x 595 x 20 | £123.50 |
| 600/900 | WMB2020 | 600 x 900 x 30 | £346.00 | Hannah 420/800 | MPS402 | 420 x 800 x 20 | £141.00 |

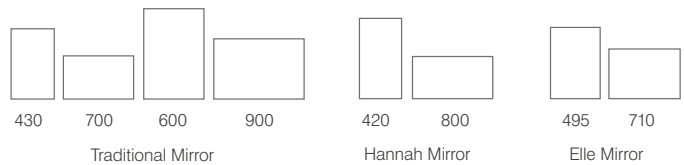

SAFETY ZONES & ELECTRICAL INFORMATION

ZONES FOR EQUIPMENT IN CLOSE PROXIMITY TO BATHS & SHOWERS



Roper Rhodes illuminated mirrors, cabinets & lighting have been independently tested for compliance with electrical equipment safety regulations. Products shown with the 'tick' icon are IP44 or IP55 rated and are suitable for use in zone 2 and outside zones in the bathroom. Roper Rhodes recommends that products installed in Zone 1 are a minimum of IP65

ZONE 1 Roper Rhodes recommends that products installed in Zone 1 are a minimum of IP65

ZONE 2 Electrical fittings in this zone require a minimum rating of IP44 (splash-proof)

OUTSIDE ZONES Electrical fittings in this zone require a minimum rating of IP20



GUARANTEE
against manufacturing
defects

Discover

ROPER RHODES CABINETS

AT THE WAVE OF A HAND

Easily control your cabinet with our intuitive contactless controls. Designed with you in mind, these controls add simplicity and convenience to your everyday tasks, plus they're hygienic too.



CHARGING SOLUTIONS

Discover true convenience with our range of charging enabled mirrors and cabinets. Sleekly designed hidden sockets are perfect for tooth brushes or razors. Plus, wireless charging is available in our Boost cabinet (page 332), perfect for charging your phone when you're busy getting ready.



BEAUTY STORAGE, BUILT STRONG

Our shelves are designed to carry all manner of cosmetics, as we static load test them to hold an extra 10kg of weight for 10 days minimum.



DOORS BUILT TO ENDURE

Our cabinet doors undergo a dynamic load test to ensure the hinges stay strong under real-life use through a 30kg weight being applied for 10 days with the cabinet only passing if it remains attached.

6000K

Cool to warm

2700K



FIND YOUR PERFECT LIGHT

Transform your space with ingenious colour changing technology. Invigorate your morning with bright, crisp daylight. Or wrap yourself in a soft, warm glow and as you spend an hour relaxing in the bath. With a wide spectrum LED ranging from 2700-6000K, you can easily shift your cabinet lighting from bright and white to warm and intimate at the simple touch or wave of the hand.



RECESSIBLE DESIGN OPTION

Give your bathroom a modern edge and save space at the same time with one of our stylish recessible cabinets. Opt for the customisable Vault (page 328) or the on-trend black finish Boost (page 332).



STORAGE SOLUTIONS

Great cabinets are all about great storage. Our cabinets offer a wide range of sizes to suit your space, and stylish internal shelves which are adjustable to help keep all your bits and bobs organised.

Making the perfect choice

CABINET FEATURES & BUYING GUIDE

Use the table below to guide you around our cabinet collection and help you find the features which are important to you when selecting your new cabinet.

| | LED lighting | Variable warm to cool & dimmable LEDs | Infrared sensor | Touch controls | Heated demister | Two-pin charging socket | USB charging socket | USB-C charging socket | Wireless charging | Recessible or Recessed | Slim depth | Soft close doors | Push to open doors | Double sided mirror doors |
|------------|--------------|---------------------------------------|-----------------|----------------|-----------------|-------------------------|---------------------|-----------------------|-------------------|------------------------|------------|------------------|--------------------|---------------------------|
| Silhouette | ● | ● | ● | | | ● | ● | ● | | | | ● | | ● |
| Vault | ● | ● | | ● | ● | ● | ● | ● | | ● | | ● | | ● |
| Novella | ● | ● | ● | | ● | ● | ● | ● | | | | ● | | ● |
| Notion | ● | ● | ● | | ● | ● | ● | ● | | | | | ● | ● |
| Boost | ● | ● | ● | | ● | ● | ● | ● | ● | ● | ● | | ● | ● |
| Theory | | | | | | | | | | | ● | ● | | ● |
| System | ● | ● | ● | | ● | ● | ● | | | | | ● | | ● |
| Medicab | | | | | | | | | | | | ● | | |



GUARANTEE
against
manufacturing
defects



GUARANTEE
on all
electrical
components





LED LIGHTING

Energy efficient LEDs provide high quality and bright illumination whilst being 80% more efficient than older incandescent lights



VARIABLE WARM TO COOL LEDs & DIMMABLE

Flexibility to adjust the LED warmth and brightness from an invigorating daylight white (6000K) to a relaxing warm white (2700K)



INFRARED SENSOR

Easy to use, an infrared sensor allows you to control the mirror with just the wave of your hand without touching the cabinet



HEATED DEMISTER

Maintain a steam-free cabinet reflection in the bathroom with an integrated heated demister pad



TWO-PIN CHARGING SOCKET

Conveniently positioned, this charging socket keeps your electric toothbrush or shaver fully charged



USB SOCKET

Easily accessed USB socket keeps your devices fully charged



WIRELESS CHARGING BOOST

Perfect for charging your phone/device when you're busy getting ready



RECESSED OR RECESSIBLE

Recessing the cabinet within the wall is a great way to conceal your bathroom accessories whilst maintaining a clean and clutter free bathroom



SOFT CLOSE DOORS

Most of our cabinets feature soft close doors to ensure quiet and controlled closure



PUSH TO OPEN DOORS

Intuitive push to open mirrored cabinet doors



DOUBLE SIDED MIRROR DOORS

Double sided mirrored glass means the cabinet mirror can be used when open or closed



TOUCH CONTROLS

Touch controls offer easy on/off and feature access right from the mirror



IP44 RATED

Cabinets indicated with this symbol are IP44 rated, making them suitable for use within zone 2 of the bathroom



Make a design statement

SILHOUETTE



GUARANTEE
against
manufacturing
defects



GUARANTEE
on all
electrical
components

- Backlit ambient lighting with additional internal lighting
- Contactless Infrared sensor
- Adjustable LED colour temperature & brightness
- Built in two-pin charging socket for your shaver or toothbrush
- Additional USB & USB-C charging socket
- Double sided mirror door
- Reversible door (Pill cabinets)
- Gunmetal finish
- Smoked glass shelves
- IP44 rated



| Silhouette Cabinets | Code | W x H x Dmm | RRP |
|---------------------|-----------|------------------|---------|
| Pill | SHC4590P | 455 x 905 x 140 | £675.00 |
| Column pill | SHC50145P | 505 x 1455 x 140 | £899.00 |
| Arch | SHC5090A | 505 x 905 x 140 | £675.00 |



USB CHARGING
Convenient built-in two-pin and USB makes it easy to power and keep your bathroom devices fully charged

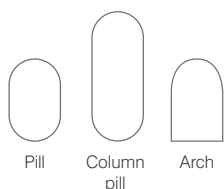

Customisable design

VAULT

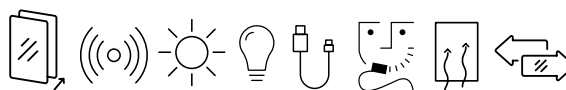

10
YEAR
GUARANTEE
against
manufacturing
defects

2
YEAR
GUARANTEE
on all
electrical
components

- Cabinet can be recessed or surface mounted
- Mirrored, black or colour matched side options to pair with Roper Rhodes furniture finishes
- Touch bar control operation
- Adjustable LED colour temperature & brightness
- Built in two-pin charging socket for your shaver or toothbrush
- Additional USB & USB-C charging socket
- Internal mirrored back panel
- Double sided mirror doors with heated demister pad
- IP44 rated

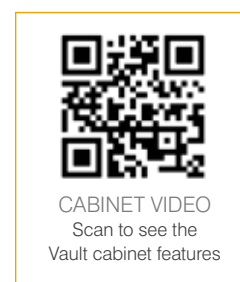

| Vault Cabinets | W x H x Dmm | Silver | RRP | Black | RRP | Brushed brass | RRP | Brushed bronze | RRP |
|----------------|------------------|--------|---------|-----------|---------|---------------|---------|----------------|---------|
| 500 1 Door | 500 x 700 x 113 | VTC050 | £565.00 | VTC050-BL | £675.00 | VTC050-BR | £675.00 | VTC050-BZ | £675.00 |
| 650 2 Door | 650 x 700 x 113 | VTC065 | £675.00 | VTC065-BL | £775.00 | VTC065-BR | £775.00 | VTC065-BZ | £775.00 |
| 800 2 Door | 800 x 700 x 113 | VTC080 | £775.00 | VTC080-BL | £885.00 | VTC080-BR | £885.00 | VTC080-BZ | £885.00 |
| 1000 2 Door | 1000 x 700 x 113 | VTC100 | £885.00 | VTC100-BL | £995.00 | VTC100-BR | £995.00 | VTC100-BZ | £995.00 |

Vault Side Panels - (No sides required if recessed)

Choose your side panel finish, replace the XX with the relevant code below

Code

RRC-CSK.XX

| | | | | | | | | | | |
|---------------|----------------------|------------------|------------------|--------------------|-------------------|---------------------|----------------------|--------------------|------------------------|--------------|
| | | | | | | | | | | |
| Mirror MIR | Matt black ALUBLK | Gloss white W | Matt white MW | Derwent blue DB | Matt agave AGM | Coniston blue CB | Juniper green JNP | Matt carbon MCB | Gloss light grey LG | Terra TER |
| £10.80 | £21.50 | £107.50 | £107.50 | £107.50 | £107.50 | £107.50 | £107.50 | £107.50 | £107.50 | £107.50 |



Powder grey
POW

£107.50



Sand oak
SNO

£107.50



Tuscan Walnut
TU

£107.50



Dusk blue
DSK

£107.50



Matt burgundy
BY

£107.50



Matt black
BLK

£107.50



Matt sage green
SGN

£107.50



500



600

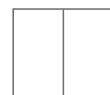

800



1000

Intuitive design

NOVELLA

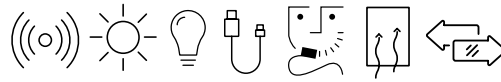

GUARANTEE
against
manufacturing
defects



GUARANTEE
on all
electrical
components

- Infrared switch controlled by contactless hand movements
- Adjustable LED colour temperature & brightness
- Handheld vanity mirror with 5x magnification
- Built in two-pin charging socket for your shaver or toothbrush
- Additional USB & USB-C charging socket
- Ambient downlight
- Aluminium construction
- Internal mirrored back panel
- Double sided mirror doors with heated demister pad
- IP44 rated



VANITY MIRROR

Novella cabinet is supplied with a handheld vanity mirror with 5x magnification. The mirror can be used handheld, clipped to shelf or freestanding.



CABINET VIDEO
Scan to see the Novella
cabinet features

| Novella Cabinets | Code | W x H x Dmm | RRP |
|------------------|--------|-----------------|---------|
| 500 1 Door | NVC050 | 500 x 700 x 145 | £620.00 |
| 600 2 Door | NVC060 | 600 x 700 x 145 | £805.00 |
| 800 2 Door | NVC080 | 800 x 700 x 145 | £905.00 |



500 600 800

Versatility at its best

NOTION

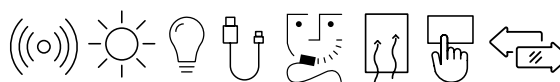

10
YEAR
GUARANTEE
against
manufacturing
defects

2
YEAR
GUARANTEE
on all
electrical
components

- Infrared switch controlled by contactless hand movements
- Adjustable LED colour temperature & brightness
- Internal lighting
- Mirrored sides
- Built in two-pin charging socket for your shaver or toothbrush
- Additional USB & USB-C charging socket
- Can be used with the loop vanity mirror
- Double sided push to open mirror doors with heated demister pad
- Adjustable smoked glass shelves with low profile supports.
- Aluminium construction
- IP44 rated



LOOP UPGRADE
Our Loop vanity mirror (VM02) can be used with all Notion cabinets



MAGNIFICATION VANITY MIRRORS
VM02 features 5x magnification without illumination, while VM03 offers 3x magnification with built-in lighting. The non-illuminated mirror can be used handheld, clipped to an open shelf, or positioned freestanding. The illuminated mirror attaches magnetically to the cabinet's interior strip or rests on its charging ring to stay powered.

| Notion Cabinets | Code | W x H x Dmm | RRP |
|-----------------|--------|-----------------|-----------|
| 600 2 Door | NTC060 | 590 x 700 x 120 | £885.00 |
| 800 2 Door | NTC080 | 790 x 700 x 120 | £1,020.00 |

| Optional Vanity Mirror | Code | RRP |
|--|------|--------|
| 5x Magnification Vanity Mirror | VM02 | £40.20 |
| 3x Magnification Illuminated Vanity Mirror | VM03 | £99.00 |

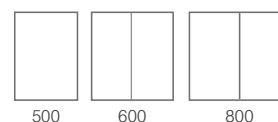

Modern space saving
BOOST

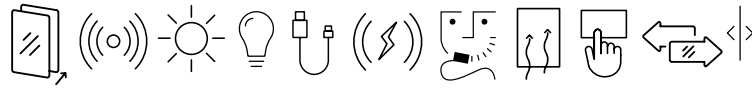

10
YEAR
GUARANTEE
against
manufacturing
defects

2
YEAR
GUARANTEE
on all
electrical
components



CAN BE
SURFACE
MOUNTED OR
RECESSED

- Wireless charging pad
- Infrared switch controlled by contactless hand movements
- Adjustable LED colour temperature & brightness
- Removable mirrored sides allowing surface mounting or recessing of cabinet
- Built in two-pin charging socket for your shaver or toothbrush
- USB & USB-C charging sockets
- Can be used with the loop vanity mirror
- Double sided push to open mirror doors with heated demister pad
- Adjustable smoked glass shelves
- Aluminium construction
- IP44 rated



Cool to warm



5W WIRELESS CHARGING PAD
give your mobile a battery boost

| Boost Cabinets | Code | W x H x Dmm | RRP |
|----------------|--------|-----------------|-----------|
| 500 1 Door | BTC050 | 490 x 800 x 120 | £860.00 |
| 600 2 Door | BTC060 | 590 x 800 x 120 | £1,020.00 |
| 800 2 Door | BTC080 | 790 x 800 x 120 | £1,140.00 |

| Optional Vanity Mirror | Code | RRP |
|--------------------------------|------|--------|
| 5x Magnification Vanity Mirror | VM02 | £40.20 |

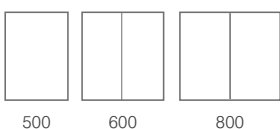

5X MAGNIFICATION VANITY MIRROR
A handheld vanity mirror with 5x magnification.
The mirror can be used handheld, clipped to shelf (when doors are open) or freestanding.

Soft curved edges
THEORY



10
YEAR
GUARANTEE
against
manufacturing
defects

2
YEAR
GUARANTEE
on all
electrical
components

- Striking black framed door & sides
- Double sided soft close mirror doors
- Slim depth design
- Adjustable smoked glass shelves
- Aluminium construction



5X MAGNIFICATION VANITY MIRROR
A handheld vanity mirror with 5x magnification. The mirror can be used handheld, clipped to shelf (when doors are open) or freestanding.

| Theory Cabinets | Code | W x H x Dmm | RRP |
|--------------------------------|--------|-----------------|---------|
| 450 1 Door | TYC045 | 450 x 700 x 120 | £396.00 |
| 600 2 Door | TYC060 | 600 x 700 x 120 | £456.00 |
| Optional Vanity Mirror | | Code | RRP |
| 5x Magnification Vanity Mirror | | VM02 | £40.20 |

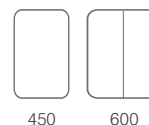

Soft rounded corners

SYSTEM



10
YEAR
GUARANTEE
against
manufacturing
defects

2
YEAR
GUARANTEE
on all
electrical
components



- Infrared switch controlled by contactless hand movements
- Adjustable LED colour temperature & brightness
- Available in two finishes, silver or black
- Built in two-pin charging socket for your shaver or toothbrush
- Additional USB charging socket
- Double sided soft close mirror doors with heated demister pad
- 2 adjustable glass shelves
- Aluminium construction
- IP44 rated



ADJUSTABLE LIGHTING
Cool to warm

| System Cabinets | Silver | Black | W x H x Dmm | RRP |
|-----------------|--------|-----------|------------------|-----------|
| 500 1 Door | SYC050 | | 500 x 700 x 140 | £785.00 |
| 600 2 Door | SYC060 | SYC060-BL | 600 x 700 x 140 | £980.00 |
| 1000 2 Door | SYC100 | - | 1000 x 700 x 140 | £1,160.00 |

| Optional Vanity Mirror | Code | RRP |
|--------------------------------|------|--------|
| 5x Magnification Vanity Mirror | VM02 | £40.20 |



5X MAGNIFICATION VANITY MIRROR
A handheld vanity mirror with 5x magnification. The mirror can be used handheld, clipped to shelf (when doors are open) or freestanding.

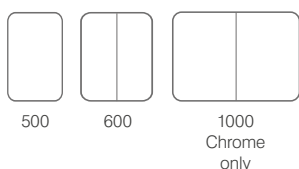

Lockable cabinet

MEDICAB

- White finish
- Lockable cabinet with 2 keys
- 1 adjustable shelf
- Can be installed for left or right hand opening
- Optional first aid label (complies with BS5378)



| Cabinets | Code | W x H x Dmm | RRP |
|------------------|--------|-----------------|---------|
| Medicab - 1 Door | MED340 | 337 x 420 x 155 | £163.50 |



337

Bathroom charging

CHARGING STATION

Add further functionality to your new bathroom by adding our charging station. The subtle little unit can be installed into our floor cupboards or wall cabinets* and includes both a two-pin charging socket and a USB port to keep all your electricals fully charged.

- Designed for use within cupboards and wall cabinets*
- Includes a two-pin charging point with rocker switch
- Includes a USB charging socket
- Supplied in a modern matt black finish
- Designed with cover to hide sockets when not in use
- Screwless mounting
- Requires a mains connection (supplied with one metre flying lead)
- Not recommended for installations in semi-countertop units or drawers
- IP44



| | Code | RRP |
|------------------|--------|---------|
| Charging station | DC6001 | £161.00 |



*Not recommended for use in semi-countertop units or drawers



WC SEATS & BATH PANELS



Explore our seats & panels

As one of the UK's leading suppliers, you know you'll be in safe hands with our best-selling range of stylish seats. Designed to perfectly pair comfort and modern ingenuity, our seats offer a variety of useful features as well great guarantees.

Plus, stylish bath panels including a choice of furniture coordinating finishes to create a seamless look.

Discover

ROPER RHODES TOILET SEATS



QUICK RELEASE HINGES

Easy to operate quick release hinges are featured on some toilet seats, allowing the seat to be lifted away easily, leaving clear access to clean otherwise hard to reach surfaces.

SEAT HINGE OPTIONS

Optional seat hinge upgrades for the following WC seats:
8909WSC-SF page 339
8901WSC-SF page 339
8910WSC-SF page 341
8903WSC-SF page 341
8904WSC-SF page 341



| | | |
|---------------|--------|--------|
| Black | DC4055 | £20.00 |
| Brushed brass | DC4056 | £20.00 |

Secure-Fix QR

SECURE-FIX QR

Adjustable hinge technology that simplifies the installation of quick release seats and keeps the seat firmly in place.



QUICK RELEASE

Allows the seat to be lifted away easily, leaving clear access to clean otherwise hard to reach surfaces.



TOP FIX HINGES

Some seats feature a special 'top fix' hinge allowing them to be quickly and easily installed on modern WC pans.



ANTI-BACTERIAL PROTECTION

An environmentally friendly built-in additive provides a hygienic finish to a number of our toilet seats and protects against bacteria, fungi and microbes.



SOFT CLOSE HINGES

The hydraulic hinge mechanism ensures controlled and quiet closure of the seat lid and ring. Mechanisms are extensively tested to ensure long life.



EPD HUB

Roper Rhodes are dedicated to developing products that have consideration to their environmental impact and their full product life cycle. The introduction of 3rd party verified environmental product declarations (EPDs) in accordance with the European standard EN 15804 are now in place.



GUARANTEES

All our solid wood toilet seats are made using the finest timber from sustainable sources and benefit from a 2 year guarantee against seat breakages. Our thermoset and MDF toilet seats include either a 5 or 10 year guarantee against seat breakages.

SOFT CLOSE QUICK RELEASE WC SEATS



Neutron soft close toilet seat

376(w) x 452mm(d)

Weight 1.8kg, compatible with most WCs, highly durable thermoset plastic for strength and longevity, adjustable hinges with **Secure-Fix QR** technology keep seat firmly in place, non-slip buffers, extremely hard wearing impact resistant surfaces, under-fix fixings also supplied for compatibility with older WCs.

| | | |
|-------|------------|--------|
| White | 8901WSC-SF | £62.90 |
|-------|------------|--------|

Secure-Fix QR

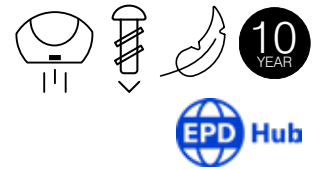

Neutron 100% recycled soft close toilet seat

374(w) x 444mm(d)

Weight 1.5KG, seat, Cover & barrel made from 100% post-consumer recycled polypropylene plastic, standard size replacement WC seat, single button quick release hinges, soft close **Secure-Fix QR** hinges keeps the seat firmly in place, top & under fixings, universal seat, 45% Reduction in product carbon emissions over a thermoset seat alternative of the same weight

| | | |
|-------|------------|--------|
| White | 8909WSC-SF | £35.00 |
|-------|------------|--------|

Secure-Fix QR

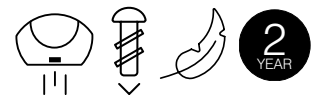

Prime soft close toilet seat

368(w) x 440mm(d)

Weight 2.2KG, compatible with most WCs, wrap-over design, highly durable thermoset plastic for strength and longevity, adjustable hinges with **Secure-Fix QR** technology keep seat firmly in place, non-slip buffers, extremely hard wearing impact resistant surfaces with an anti-bacterial finish

| | | |
|-------|------------|--------|
| White | 8907WSC-SF | £69.50 |
|-------|------------|--------|

Secure-Fix QR



SOFT CLOSE WC SEAT



Curve soft close toilet seat

380(w) x 445mm(d)

Weight 2.4kg, contemporary wrap over lid design, highly durable thermoset plastic for strength and longevity, extremely hard wearing impact resistant surfaces with anti-bacterial protection.



| | | |
|-------|---------|--------|
| White | 8402WSC | £83.70 |
|-------|---------|--------|

D-SHAPED SOFT CLOSE WC SEATS



Secure-Fix

Define soft close toilet seat

376(w) x 458mm(d)

Weight 2.5kg, wrap around design, highly durable thermoset plastic for strength and longevity, extremely hard wearing impact resistant surfaces with anti-bacterial protection.



| | | |
|-------|------------|--------|
| White | 8704WSC-SF | £90.00 |
|-------|------------|--------|



STANDARD CLOSE WC SEAT



Infinity heavy duty toilet seat

375(w) x 445mm(d)

Weight: 2.4kg. A heavy duty sandwich seat which fits most standard shaped toilet suites and is available with either chrome plated soft close hinges or standard close stainless steel hinged options. Extremely hard wearing impact resistant surfaces with anti-bacterial protection.



| | | |
|-------|--------|--------|
| White | 8401WS | £67.90 |
|-------|--------|--------|



Secure-Fix QR

Diode 360 soft close toilet seat

355(w) x 435mm(d)

Weight 2.7kg, highly durable thermoset plastic, single button quick release for ease of cleaning, soft close hinges with **Secure-Fix QR** technology keeping the seat firmly in place, top & under fixings, hard wearing, impact resistant.

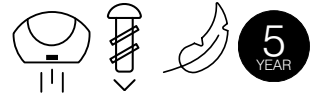

| | | |
|-------|------------|--------|
| White | 8910WSC-SF | £62.90 |
|-------|------------|--------|



Secure-Fix QR

Diode soft close toilet seat

370(w) x 455mm(d)

Weight 2.3kg, highly durable thermoset plastic, single button quick release for ease of cleaning, adjustable hinges with **Secure-Fix QR** technology keep seat firmly in place, non-slip buffer, extremely hard wearing impact resistant surfaces with anti-bacterial protection, under-fix fixings also supplied for compatibility with older WCs.



| | | |
|-------|------------|--------|
| White | 8903WSC-SF | £69.60 |
|-------|------------|--------|



Secure-Fix QR

District soft close toilet seat

368(w) x 455mm(d)

Weight 2.3kg, highly durable thermoset plastic, single button quick release for ease of cleaning, adjustable hinges with **Secure-Fix QR** technology keep seat firmly in place, non-slip buffer, extremely hard wearing impact resistant surfaces, under-fix fixings also supplied for compatibility with older WCs.



| | | |
|-------|------------|--------|
| White | 8904WSC-SF | £69.60 |
|-------|------------|--------|

Diode/District (8903WSC-SF/8904WSC-SF)

Imex – Arco | Blade | Duro | Ivan
 Villeroy & Boch – Subway | Subway 2.0 | Subway 3.0 | Architectura Avento | O.novo
 Vitra – S50 | Zentrum | Integra
 Roca – Inspira Round | Ona | Meridian-N | Nexo
 Duravit – D-Neo | Duravit No. 1

Diode/District (8903WSC-SF/8904WSC-SF)

Laufen – Sonar, Kartell | Pro
 Twyfords – E100 Round
 RAK – Resort | Tonique | Compact
 R2 – Radar | Debut
 Tavistock – Micra Evo

MOULDED WOOD MDF WC SEATS



Chrome hinges



Brushed brass hinges

Secure-Fix QR



Gloss white

Secure-Fix QR



Matt mocha

Secure-Fix QR



Matt pewter

Secure-Fix QR



Matt agave



Matt black

Painted wood soft close toilet seat

375(w) x 430mm(d)

Designed to fit on our traditional WCs and complement Hampton furniture. Made with a contoured lid detail and substantial 20mm thick seat ring, our painted seat will also fit most standard shaped WCs. An MDF substrate makes the seats extremely strong with a beautiful painted finish. Featuring non-slip colour coordinated buffers and an extremely hard wearing matt polyurethane painted finish for the best seat in the house.

Secure-Fix QR technology helps keep the seat firmly in place.

With chrome hinges

| | | |
|-------------|------------|---------|
| Gloss white | HSCTSW-SF | £137.50 |
| Matt mocha | DC4006-SF | £135.00 |
| Matt pewter | DC4008 | £135.00 |
| Matt agave | DC4010-SF | £135.00 |
| Matt black | HASCTSB-SF | £137.50 |

With brushed brass hinges

| | | |
|-------------|-------------|---------|
| Gloss white | HSCTSWB-SF | £137.50 |
| Matt black | HASCTSBB-SF | £137.50 |

SOLID WOOD WC SEATS



Secure-Fix QR

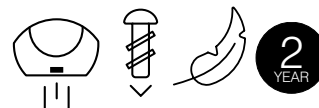

1



2



3



4



5



6



Traditional soft close toilet seat

370(w) x 434mm(d)

Traditionally sized to fit most toilet suites, the Traditional seat also boasts quick release adjustable hinges with Secure-Fix QR technology keep the seat firmly in place. Made using the finest sustainably sourced solid timbers, with dowel reinforced seat rings to prevent splitting. Soft close chrome plated hinges, non slip colour coordinated buffers and an extremely hard wearing matt lacquer make this the market leading wooden toilet seat.

* Mahogany and Antique pine seats are manufactured using solid beech for a sustainable and longer lasting finish.

| | | |
|------------------------|-------------|---------|
| 1. Mahogany finish | 8081MSC-SF | £130.50 |
| 2. Antique pine finish | 8081ASC-SF | £130.50 |
| 3. Limed oak | 8081LISC-SF | £153.00 |
| 4. Oak | 8081NOSC-SF | £148.50 |
| 5. Walnut | 8081AWSC-SF | £172.00 |
| 6. Honey oak | 8081HOSC-SF | £148.50 |

ISOCORE BATH PANELS



ISOCORE BATH PANELS

A revolutionary, 100% waterproof material which will not degrade with exposure to moisture.

A lightweight material which is 30% lighter than MDF.

Easy to cut without the need to re-seal, and do not need to be fully sealed during installation.



Helios Isocore bath panels

455(h)mm Plinth 140(h)mm - 12mm thick

Helios Isocore waterproof gloss white plain bath panel & plinth complete with a lifetime guarantee. A revolutionary, 100% waterproof material which will not degrade with exposure to moisture. Top lip for easy install with standard bathtubs

| | | |
|--------------------------|--------|----------------|
| 1800mm White front panel | DC5016 | £151.00 |
| 1700mm White front panel | DC5001 | £139.00 |
| 800mm White end panel | DC5015 | £80.20 |
| 750mm White end panel | DC5017 | £74.60 |
| 700mm White end panel | DC5002 | £74.60 |



Waterproof Bath Panels - 100% Waterproof

Panel 460(H) - 15mm thick

Plinth 120(H) - 15mm thick

Waterproof gloss white plain bath panel & plinth complete with a lifetime guarantee. A revolutionary, 100% waterproof material which will not degrade with exposure to moisture.

| | | |
|--------------------------|--------|----------------|
| 1800mm White front panel | DC5024 | £114.00 |
| 1700mm White front panel | DC5023 | £99.00 |
| 800mm White end panel | DC5022 | £60.00 |
| 750mm White end panel | DC5021 | £55.00 |
| 700mm White end panel | DC5020 | £50.00 |

WOODEN BATH PANELS

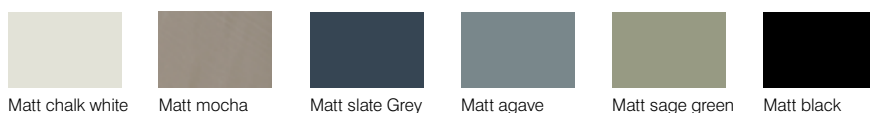

Hampton 1700mm front panel

1695(l) x 500mm(h)

All bath panels include matching height adjustable plinths
Height adjustable range 450 - 590mm

| | | |
|------------------|---------|---------|
| Matt chalk white | DC5003F | £223.50 |
| Matt mocha | DC5004F | £223.50 |
| Matt slate grey | DC5005F | £223.50 |
| Matt agave | DC5008F | £223.50 |
| Matt sage green | DC5026F | £223.50 |
| Matt black | DC5025F | £223.50 |

Hampton 700mm end panel

695(l) x 500mm(h)

All bath panels include matching height adjustable plinths
Height adjustable range 450 - 590mm

| | | |
|------------------|---------|---------|
| Matt chalk white | DC5003E | £124.50 |
| Matt mocha | DC5004E | £124.50 |
| Matt slate grey | DC5005E | £124.50 |
| Matt agave | DC5008E | £124.50 |
| Matt sage green | DC5026E | £124.50 |
| Matt black | DC5025E | £124.50 |



Uno 1700mm front panel

1695(l) x 500mm(h)

Includes matching plinth, height adjustable range
500 - 620mm, corner post suitable for use with these panels

| | | |
|-------|---------|---------|
| White | BP4000W | £201.00 |
|-------|---------|---------|

Uno 700mm end panel

685(l) x 500mm(h)

Includes matching plinth, height adjustable range
500 - 620mm, corner post suitable for use with these panels

| | | |
|-------|---------|---------|
| White | BP4001W | £120.50 |
|-------|---------|---------|



800 series Isocore 1700mm front panel

1695(l) x 450 - 570mm(h)

Isocore waterproof gloss white plain bath panel & plinth complete with a lifetime guarantee. A revolutionary, 100% waterproof material which will not degrade with exposure to moisture.

All bath panels include matching height adjustable plinths
Height adjustable range 450 - 590mm
corner post suitable for use with these panels

| | | |
|-------|--------|----------------|
| White | BP800W | £270.00 |
|-------|--------|----------------|

800 series Isocore 700mm end panel

685(l) x 450 - 590mm(h)

Isocore waterproof gloss white plain bath panel & plinth complete with a lifetime guarantee. A revolutionary, 100% waterproof material which will not degrade with exposure to moisture.

All bath panels include matching height adjustable plinths
Height adjustable range 450 - 590mm
corner post suitable for use with these panels

| | | |
|-------|--------|----------------|
| White | BP801W | £141.00 |
|-------|--------|----------------|



Corner posts for 1700mm x 750mm baths



Corner posts for 1800mm x 800mm baths



Corner posts

Suitable for use with 800 series & Uno bath panels

One of the unique features of the range is the corner post. Available in gloss white, a corner post enables panels (where indicated) to be adapted for use with 1800 x 800mm or 1700 x 750mm baths as shown in the diagrams above

Height of 600mm

Suitable for plinth installations

Can be cut down to suit your installation

| | | |
|-------|-----------|---------------|
| White | CPOST600W | £82.10 |
|-------|-----------|---------------|

Keeping in touch

CUSTOMER SERVICE & AFTERCARE



As one of the UK's largest suppliers of bathroom furniture & accessories, we set very high standards in design, manufacture & service. We also invest heavily in product improvement & innovation. By choosing Roper Rhodes, you can be confident that your product is of unrivalled quality.



OUR BROCHURES

Explore the rest of the Roper Rhodes collection with our dedicated Fitted Furniture, Bathing Collection and Lighting, Mirrors & Cabinets brochures. Ask your local retailer for a copy or visit our website to order or download one. roperrhodes.co.uk/brochures/



RETAILERS

Roper Rhodes products are available to view at our selected specialist stockists throughout the UK and Ireland. Head over to our website now to find your nearest supplier. roperrhodes.co.uk/stockists/



SWATCH SAMPLE SERVICE

Our free swatch sample service is designed to help you make the right finish choices for your home. If you would like a sample of any of our finishes please visit our website and fill in the sample request form. roperrhodes.co.uk/swatches/

Alternatively you will find displays of our furniture and colour samples of finishes and worktops at our specialist retailers across the UK and Ireland.



WEBSITE

Visit our website to find even more inspiration for your next bathroom project, with detailed guides and inspiring articles. Here you can also find technical details for all our products, as well as access our customer service team and list of stockists. roperrhodes.co.uk

HOW TO CONTACT US

If you need to contact us, our experienced in-house customer service team has a wealth of knowledge about our products.

01225 303900

sales@roperrhodes.co.uk

Monday to Thursday - 8:00am - 5:30pm

Friday - 8:00am - 5:00pm

GUARANTEES

Many of our products carry lengthy guarantees. Our furniture, showers and taps carry 10 year guarantees. 20 year guarantee on basins and WCs whilst our seats either have a 2 or 10 year guarantee. Our lighting offers 3 years for manufacturing defects and 2 years on consumables like the bulbs and switches. Our mirrors and cabinets carry a 10 year guarantee for all mirror glass, carcasses and doors with all electrical components covered by a 2 year guarantee. Please see individual product sections for details. Guarantees are for domestic use only and are not transferable.

REPLACEMENT PARTS

We carry extensive stocks of replacement parts and are normally able to dispatch spares within 24 hours of your request. Damaged parts will be replaced with a spare part where possible, complete exchanges will only be made where it is not practical to do so.

PRICING

All prices quoted are inclusive of Value Added Tax, which will be charged at the rate applicable on the date your product is dispatched. The prices charged will be those ruling at the date of dispatch and Roper Rhodes cannot be held responsible for any errors or omissions in this brochure.

PRODUCT SPECIFICATION

Roper Rhodes furniture is designed for use within domestic installations which are adequately ventilated and is not suitable for installation in wet rooms. As with any timber product, bathroom furniture will be adversely affected if it is subjected to excessive moisture. It is strongly recommended that adequate bathroom extractor fans are installed to prevent heavy condensation and all splashes and spillages must be mopped dry as soon as possible. All exposed or cut surfaces must be sealed with a suitable varnish or silicone sealant to prevent blowing. If this is not done, all warranty claims will be void. In particular, silicone sealant must be used around basin and worktop joints and around all edges of bath panels and plinths. All electrical products should be installed by an approved electrician in line with current wiring regulations.

Roper Rhodes Ltd reserves the right to amend the specification of its products at any time if an opportunity to improve the product occurs. All dimensions are approximate and are quoted within reasonable tolerances.

The furniture colours shown in this brochure are representative only and can be affected by a multitude of factors such as lighting and surrounding items.

Products with a brass finish may not match exactly due to variations in the brass alloy composition, differences in finishing techniques, natural aging processes causing patina and the lighting they are compared in. Imagery shown in this brochure is representative only.

ACKNOWLEDGEMENTS

Viewpoint photography - viewpointstudios.co.uk - 01761 420841
Kaufmann Keramik - www.kaufmann-keramik.de - +49 (9283) 89806-0
Mandarin Stone - mandarinstone.com - 01600 715 444
Sarson Stone Group - sarsonstonegroup.com - 01380 720007
Claybrook Studio - www.claybrookstudio.co.uk - 020 7052 1555
Orac Décor - www.decorative-coving.co.uk - 0208 660 2854
Bauwerk Paint - <https://www.bauwerkcolour.com> - +49 34224 469626
Eskimo - eskimodesign.co.uk - 0207 117 0110
Industville - www.industville.co.uk - 0207 971 7871
Ca Pietra - www.capietra.com - 01380 735886





ROPER RHODES®
BATH

Brassmill Lane Trading Estate, Bath, BA1 3JF
RRBBSEPT25 V2